PU Europe
Environmental and
economic analysis
of insulation
products in low
energy buildings

May 2013

Version 2.0

In accordance with EN 15643 standards



Table of content

1. Summary	6
2. Introduction	7
2.1. Context	7
2.2. Goal of the study	7
2.2.1. Main objectives	7
2.2.2. Intended use of the results	7
2.2.3. Targeted audience	8
2.3. Structure of this report	8
3. General framework	9
3.1. General methodology	9
3.2. Functional equivalents	10
3.2.1. Definition of the functional equivalents	10
3.2.2. Required service life of the buildings	11
3.3. Scenarios	11
3.3.1. Building scenarios	11
3.3.2. Reference study period	11
3.3.3. Climates	12
3.3.4. Specific scenarios for each life cycle stage	13
3.3.5. Construction process scenario	14
3.3.6. Demolition process scenario	14
3.4. Systems boundaries	14
3.4.1. Production phase (A1 to A3)	14
3.4.2. Construction phase (A4 and A5)	15
3.4.3. Use phase (B1 to B7)	16
3.4.4. End of life phase (C1 to C4)	16
4. Reference buildings presentation	17
4.1. Part A: Commercial building	17
4.1.1. General presentation	17
4.1.2. Thermal performance and energy consumptions	18
4.2. Part B: Residential building	19
4.2.1. General presentation	19
4.2.2. Thermal performance and energy consumption	20
5. Specific assumptions for assessment of economic performance	22
6. Specific assumptions for assessment of environmental performance	24

6.1. LCA methodology used	24
6.2. Functional equivalent	25
6.3. Scenarios	26
6.4. Selected environmental data	26
6.4.1. Data sources	26
6.4.2. Lifespan of building products	27
6.4.3. Data quality, completeness and consistency	27
6.5. Selected environmental impact indicators	27
6.6. Results display	29
<hr/>	
7. Results interpretation	30
<hr/>	
7.1. Part A	30
7.1.1. Life cycle costs analysis	30
7.1.2. Overall environmental life cycle analysis (LCA), at a glance	38
7.1.3. Detailed LCA results per indicator	41
<hr/>	
7.2. Part B	53
7.2.1. Life cycle costs analysis	53
7.2.2. Overall environmental life cycle analysis (LCA), at a glance	60
7.2.3. Detailed results per indicator	62
<hr/>	
8. Limitations and Sensitivity analysis	77
<hr/>	
8.1. Sensitivity analysis for different study periods	77
8.1.1. Part A	77
8.1.2. Part B	79
8.1.3. Conclusion	80
<hr/>	
8.2. Comparison between min-max values (part B)	81
8.2.1. Glass wool	81
8.2.2. Wood fibre	82
<hr/>	
8.3. Limitations	82
<hr/>	
9. Conclusions	84

Appendix A. - References

Appendix B. - LCA results

Appendix C. - Buildings description and thermal performance

Appendix D. - Bill of quantities

Appendix E. - Building drawings

Appendix F. - Detailed drawings part B

Appendix G. - Building statics study part A

Appendix H. - Construction costs Part A

Appendix I. - Maintenance costs part A

Appendix J. - Replacement costs part A

Appendix K. - Construction costs part B

Appendix L. - Maintenance costs part B

Appendix M. - Replacement costs part B

Appendix N. - Energy prices

Appendix O. - LCC definitions

Appendix P. - Specific methodology to determine representative EPDs for glass wool and stone wool

Note to the readers

The present report has been made on 2013 by PricewaterhouseCoopers Advisory upon the request of PU Europe as part of the proposal n° 5772-3 of June 2012 signed on June 2012.

PU Europe let us know its intentions of broadcasting to a large audience. We won't accept any responsibility towards third parties, the use of the report under its care coming within its own responsibility.

The present study aims at supplying factual data based on a methodology of life cycle assessments (LCA).

This study is only based on the facts, circumstances and hypothesis that have been submitted by PU Europe and that are described in the report. If these facts, circumstances and hypotheses differ, our conclusions are likely to change.

One should consider the results of this study as a whole regarding the principles and methodological limits, and not analyze them separately.

In addition, it is not part of our responsibilities to update the study according to a fact or event that could occur after our work.

Every communication of PricewaterhouseCoopers Advisory's report to third parties must include this warning.

© 2013 PricewaterhouseCoopers Advisory. All rights reserved

1. Summary

In recent years, the energy performance of buildings was mainly focused on reducing the final energy consumption associated to heating, cooling, electricity, etc. There has been a lot of progress in this field and buildings constructed in accordance with best standards and practices have now low energy consumptions. Thus, it is now also necessary to reduce embodied energy and other environmental impacts associated with the construction of buildings and the choice of materials. To allow this, an environmental assessment is the right tool to define where further reductions to energy consumption can be achieved.

The project goal was to provide evidence that the methods developed at European level provide accurate results with regards to the environmental and cost performance of a building (element) based on specific product choices. The project also aimed to prove that PU insulation features a favorable performance compared to other insulation materials. Finally, the project aimed to stress the importance of building design solutions and **demonstrate that the impact of insulation products on the overall environmental burden of building is negligible compared to their benefits in the building use phase.**

This is one of the first studies to assess both economical and environmental performances of the buildings at the same time. The assessment of the overall environmental and cost performance is based on the quantification of the contribution of insulation materials implemented in low-energy buildings. Two types of buildings and scenarios are considered: a new large commercial building and the renovation of a typical pitched roof in a dwelling.

From both analyses, **no significant variation can be observed on life cycle costs and environmental impacts between the defined scenarios** based on different insulation materials: polyurethane foam, stonewool, expanded polystyrene (part A, commercial building), glasswool and wood fibre (part B, renovation of a residential house).

As a result, since an extensive perimeter of a building's life cycle is considered, **the choice of the insulation material has not a major impact on total costs and final environmental impacts** (ie energy resources depletion, climate change, waste generation...). These conclusions are similar when considering different cold, moderate or hot European climates and a lifespan of 30, 50 or 60 years.

Environmental impacts are mainly driven by the energy consumption at use stage and most parts of the costs are related to the construction of the structure and to the energy consumption. On the life cycle of a new commercial building (50 years), operational energy consumptions represent 31% of total costs and 90% of total primary energy.

The pitched roof renovation scenario of a residential house shows that benefits on operational and, therefore, total costs and environmental impacts would be more substantial if the whole envelope of the house was renovated. Nonetheless, additional impacts due to the renovation on the whole life cycle costs and environmental impacts are not significant.

Some limits to the results and conclusions must be outlined:

- Conclusions are based on theoretical scenarios of building constructions and cannot be considered as general statements.
- Environmental impact analysis is based on a selection of impacts, which do not represent the extensive types of ecological impacts. In particular, water consumption embodied in construction products has not been assessed as consistent data were not available.
- LCC and LCA methodologies and data used are associated with a minimum level of uncertainties of 20% when interpreting the results.
- The systems' boundaries exclude some contributors, such as external landscaping and transport of users, which could be of major impacts in particular for a commercial building.

2. Introduction

2.1. Context

From the claim for “sustainable” products...

Today, there are still numerous claims in the market of “green”, “ecological” or “sustainable” products without providing scientific evidence. As the design of low and nearly zero energy buildings requires highly insulated envelopes, insulation products are therefore in the focus of public and private clients and LCA experts.

There is an increasing interest in the construction industry to understand the environmental impacts of various construction materials. On the other hand, cost is still the dominating selection criterion and looking at the life cycle costs of low energy design solutions is therefore indispensable.

...to the provision of scientific evidences of building performances

Stakeholders in CEN/TC350 have agreed on a harmonized way to determine these environmental impacts and to assess the overall performance of construction products at the building level. PU Europe commissioned a comprehensive LCA/LCC study in 2008¹. With new LCA data available, this study should be repeated and extended with the present project.

2.2. Goal of the study

2.2.1. Main objectives

The project goal is to provide evidence that the methods developed by TC350 provide accurate results with regards to the environmental and cost performance of a building (element) based on specific product choices. The project should also prove that PU insulation features a favorable performance compared to other insulation materials. Finally, the project should stress the importance of building design solutions and demonstrate that the impact of insulation products on the overall environmental burden of building is negligible.

The assessment of the overall environmental and cost performance is based on the quantification of the contribution of insulation materials implemented in low-energy buildings. Two types of buildings and scenarios are considered:

- Part A: new large commercial building ;
- Part B: renovation of a typical pitched roof in a dwelling.

2.2.2. Intended use of the results

Part A

- Identification of environmental and cost impacts of insulation on total building compared to other building elements and products (charts) for each climatic zone;
- Comparison of environmental and cost impacts of the design solutions using the different types of insulation at the building (element) level for each climatic zone;

¹ http://www.pu-europe.eu/site/fileadmin/Reports_public/LCA_LCC_PU_Europe.pdf

-
- Identification of additional material resources and costs required to achieve same building function (charts);
 - Quantification of the environmental and cost impacts of varying building footprints according to insulation material choices.

Part B

- Identification of environmental and cost impacts of insulation for the pitched roof renovation case (charts) for the moderate climatic zone;
- Comparison of environmental and cost impacts of the design solutions using the different types of insulation at the building element level for the moderate climatic zone;
- Identification of additional material resources and costs required to achieve same building element function (charts) in terms of U-value, water barriers and air-tightness.

2.2.3. Targeted audience

The results of this project are intended to be shared with decision and public policy makers, specifiers, designers and architects, who require objective, reliable and representative information based on a holistic approach of the overall sustainability performance in the building industry.

2.3. Structure of this report

The present report aims to provide objective, transparent and traceable information used to carry out the sustainability assessment, as well as the detailed results of the analyses.

Sections 3 to 6 describe the general framework and main assumptions of the study. Detailed assumptions are provided in appendices.

The section 7 Results interpretation discusses the results of the study. Section 8 describes the different limitations of the study as well as a sensitivity analysis. Finally, conclusions are discussed in section 9.

3. General framework

3.1. General methodology

The present study has been conducted within the general framework of sustainability assessment of buildings, as defined by the EN 15643-1 standard. This standard provides guidelines to carry out environmental, social and economic assessments and ensures a consistent methodology between these three different parts.

The environmental LCA of buildings is thus defined in the EN 15643-2 (Framework for the assessment of environmental performance) and EN 15978 (Calculation method) standards. The LCC analysis is based on the EN 15643-4 standard: Framework for the assessment of economic performance.

These reference documents have not only been used to settle the methodology but also to fulfill requirements for the communication of the results and limitations. This framework has been followed as far as possible, considering the following limits:

- Studied buildings are theoretical. As a result, specific data were not always determined and assumptions had to be stated, building components had to be excluded and scenarios restricted;
- Environmental data were not always available according to the latest standards, specially EPD according to EN 15804 standard;
- Prices and their evolution in time are always uncertain and vary according to the location. A sensitivity analysis will be conducted to assess the impact of changes in the key assumptions.

All deviations from the reference standards are explained in the present report.

The general methodology consists in carrying out a LCA and a LCC from the same building models, scopes and scenarios.

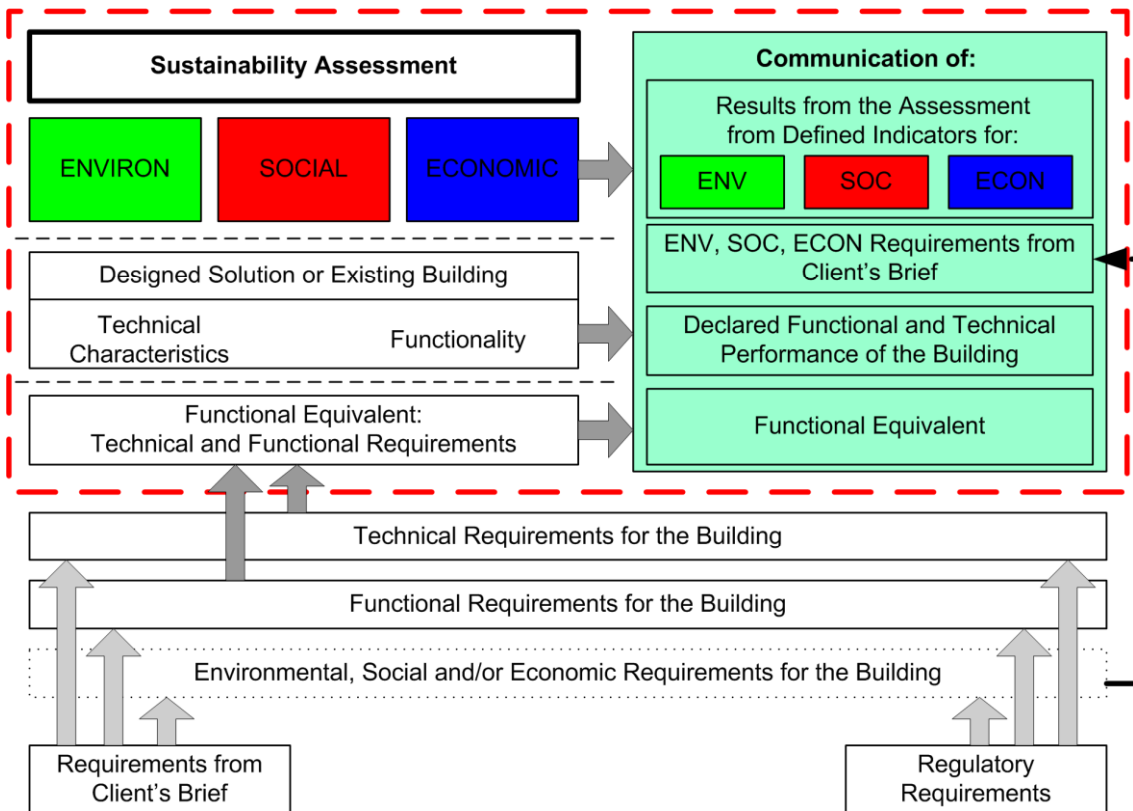

Figure 1: Concept of sustainability assessment of buildings according to EN 15643

3.2. Functional equivalents

3.2.1. Definition of the functional equivalents

According to the EN 15978 standard, a sustainability assessment must be based on the definition of a functional equivalent, which must be the same when combining environmental (LCA), economic (LCC) and social performance assessments. The functional equivalent represents the quantified functional and technical requirements for the buildings.

The main functional requirements for the studied buildings are described as follows:

	Part A	Part B
Building type	Commercial	Residential
Location	Helsinki, Brussels, Rome	Brussels
Functional unit	- internal area: 2294m ² - volume: 13993 m ³ - component U-values	- roof surface - roof U-value
Pattern of use	Retail	Individual house (family)
Required service life	50 years	50 years

Table 1: functional requirements

Regarding Part A, the functional equivalent could have been chosen as the external footprint of the building. In this case, the internal area and volume would vary from one scenario to the other (see section 3.3 Scenarios and

Appendix C.1.3 for thermal envelope details). It is interesting to further compare the best and worst scenarios from that point of view (PU vs SW). For the internal area, the loss would be 1% (2273 m² vs 2294 m²). The inner volume would be reduced by 5% in this case (13319 m³ vs 13993 m³).

3.2.2. Required service life of the buildings

The studied buildings being theoretical, their construction is not planned following actual developments. The required service life of the studied buildings is chosen on the basis of:

- building standard requirements in construction and practices (insurance warranties, renewing paste...);
- common practices amongst LCA of buildings.

A sensitivity analysis on the required service life would further illustrate the impacts of this choice on the results.

3.3. Scenarios

3.3.1. Building scenarios

Different building models have been developed to compare the overall performance of the buildings including different insulation materials. Every model has been adapted to meet the equivalent thermal performances (see appendices).

Part A

Three different insulation materials have been studied for the roof and sandwich panels in walls:

	Scenario 1	Scenario 2	Scenario 3	Scenario 4
Roof	Polyurethane (PU)	Expanded polystyrene (EPS)	Stonewool (SW)	Expanded polystyrene (EPS)
Sandwich panel (wall)	Polyurethane (PU)	Polyurethane (PU)	Stonewool (SW)	Polyurethane (PU)

Table 2: reference building scenarios, part A

Part B

Four insulation materials have been considered for the renovation of the pitched roof: polyurethane (PU), glasswool (GW), stonewool (SW), expanded polystyrene (EPS) and wood fibre (WF).

3.3.2. Reference study period

Part A

The reference study period considered is the same as the required service life of the buildings, as the intended use of the buildings over their life cycle is consistent with the scenarios covered by the required service lives.

Part B

Regarding part B, the initial construction year of the individual house is assumed to be 1997, renovation year 2012 and demolition year 2062, which corresponds to a lifespan of 50 years for the renovated roof.

3.3.3. Climates

The three climates are described below. They are based on IWE (International Weather for Energy Calculation) weather files. These files have been edited by Ashrae and are available on the DOE website.

	Cold Continental	Moderate	Mediterranean
Reference	FIN_Helsinki029740_IWE	BEL_Brussels.064510_IWE	ITA_Rome.162420_IWE
Data Source	IWE Data	IWE Data	IWE Data
Weather file design conditions	Climate Design Data 2009 ASHRAE Handbook	Climate Design Data 2009 ASHRAE Handbook	Climate Design Data 2009 ASHRAE Handbook
Heating Design Temperature 99.6% (°C)	-22.80	-7.70	-0.8
Cooling Design Temperature 0.4% (°C)	26.70	29	31
Weather file Heating Degree-Days (base 10°C)	2336.00	905	201
Weather file Cooling Degree-Days (base 18°C)	33.00	96	555
ASHRAE climate zone	6A	4A	3C
ASHRAE Description	Cold-humid	Mixed-humid	Warm-Marine
Maximum direct solar [W/m ²]	834.00	860	917
Maximum diffuse solar [W/m ²]	409.00	482	537

Table 3: description of climates

Thermal dynamic simulations will use hourly time steps. An example of hourly weather data is shown below.

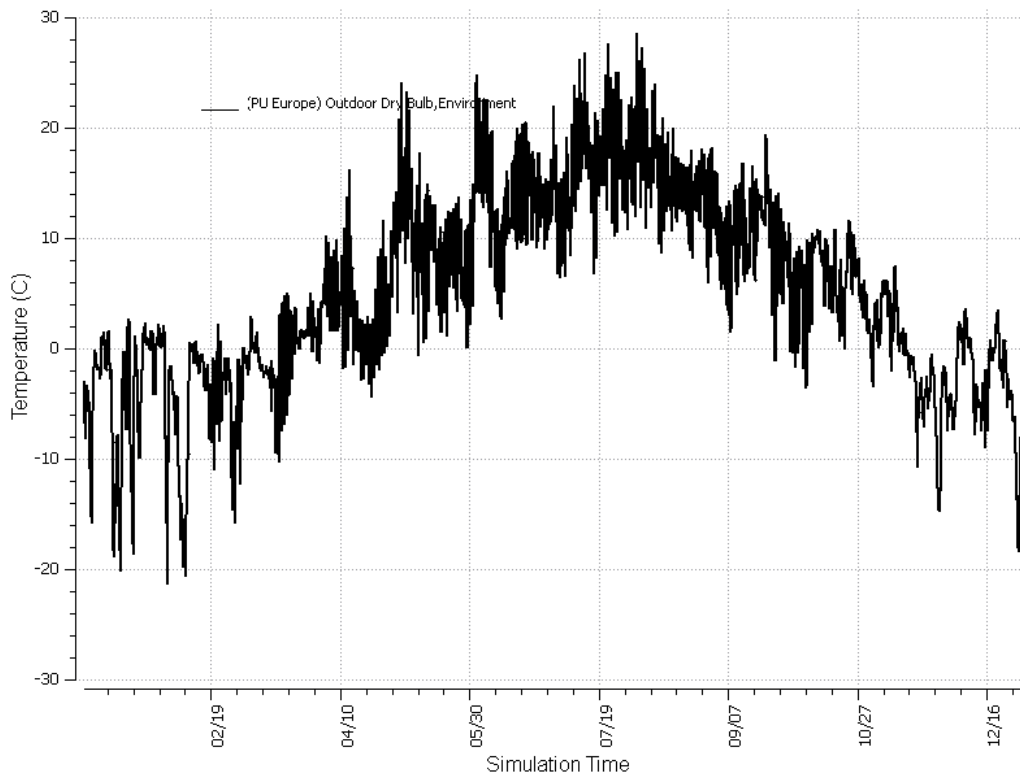

Figure 2: hourly weather data

3.3.4. Specific scenarios for each life cycle stage

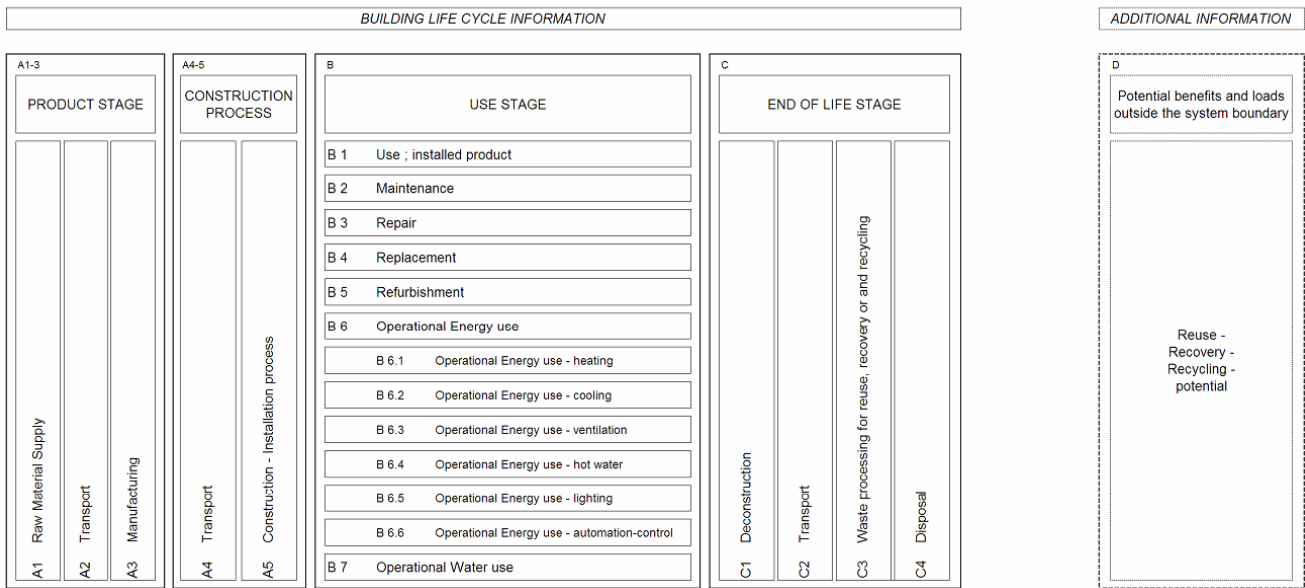

Figure 3: modular information for different life cycle stages, according to EN 15978

Life cycle stage	Part A	Part B
A1-3 Product stage	No deviations from scenarios defined in EPD of products and components	
A4-5 Construction process		
A4 Transport	Scenarios from EPD + construction equipments : 50 km on a platform truck for all equipments	
A5 Installation process	Installation of products (EPD) + use of one tower crane, 2 forklifts, a power station (group generator) cf. section 3.3.5 for details	Installation of products (EPD) + use of one forklift, power station (group generator) cf. section 3.3.5 for details
B Use stage		
B1 Use	Scenarios from EPD	
B2 Maintenance	Scenarios from EPD	
B3 Repair	Scenarios from EPD	
B4 Replacement	Scenarios from EPD + lifespan references from BBSR for insulation materials	
B5 Refurbishment	No refurbishment is considered for the commercial building	Refurbishment scenario is accounted in the product stage for the renovation case
B6 Operational Energy use	cf section 4 Reference buildings presentation	
B7 Operational Water use	Scenarios and building related water consumption (cf System boundaries at use stage, section 3.4.3)	
C End of life stage		
C1 Deconstruction	Scenarios from EPD + demolition of the whole building: demolition process to be determined	Scenarios from EPD + demolition of the whole building: demolition process to be determined

C2 Transport	Scenarios from EPD
C3 Waste processing	Scenarios from EPD
C4 Disposal	Scenarios from EPD
D Potential benefits and loads outside the system boundaries	N/A

Table 4: scenarios for each life cycle stage

3.3.5. Construction process scenario

For both parts, a typical construction process scenario is defined to include the energy consumption related to the mutual construction equipments that are not taken into account in the EPD of the building products and components.

This scenario will define the type of equipments, their nominal fuel consumption (L/h) and their utilization on site (hours per day). These equipments may include:

- a tower crane (part A only);
- forklifts;
- a power generation plant;
- excavators;
- trucks, etc.

3.3.6. Demolition process scenario

As for the construction phase, the demolition process is defined by a typical scenario describing the mutual equipments used and their fuel consumption.

3.4. Systems boundaries

3.4.1. Production phase (A1 to A3)

According to the EN 15978 standard, the constitutive parts of the buildings listed below shall be included in the assessment. This reference list has thus been used to define the systems boundaries for both environmental and economic assessment. As the studied buildings are theoretical, some constitutive parts have been excluded from the system boundaries, and justifications are provided in the following table.

Building parts	Included?	Comment
Foundations, frame (beams, columns, slabs, etc.); non load bearing elements; external walls; windows; roof; internal walls; floor; ceiling; doors and staircase(s)	Y	
Sanitary and technical systems (water, waste water, piping, pump and fixed equipment)	Y	
Fixed fire-fighting systems	N	Fire-fighting systems may be country-specific according to national regulations, their relative contribution is assumed negligible
Heating and hot water systems; mechanical ventilation and air	Y	

conditioning; fixed lighting systems		
Communication and security systems	N	These systems may be country-specific and their relative contribution is assumed negligible
Transportation inside the building (elevators, escalators)	N	Not included in building models
External lighting; external parking	N	Not relevant with regards to the objectives
Drainage system	N	Not relevant with regards to the objectives
On-site drainage and water treatment systems	N	Not relevant with regards to the objectives

Table 5: production phase

3.4.2. Construction phase (A4 and A5)

The construction phase includes:

- transport from factory gate to the site and implementation of all building components and materials (i.e. A4 and A5 of EN 15804);
- transport of construction equipments (cranes, scaffolding, carriage trucks);
- and the following construction processes:

On-site processes	Included?	Comment / related scenario
Ground works	Y	Ground works for foundations are included in production phase (assimilated to the building infrastructure).
Landscaping	N	No landscaping works are considered, as the location of the construction site is not determined. It is assumed that the construction site does not require landscaping works for the implementation of the buildings.
Storage of products (incl. provision of heating, cooling, humidity...)	N	Not relevant for the studied buildings
Transport of materials, products, waste and equipment within the site	N	Relative contribution of transport within the site is presumably negligible.
Temporary works	N	Not relevant for the studied buildings
On site transformation of the product	N	Not applicable
Installation of the products into the building (incl. ancillary materials not counted in the EPD of the products)	Y	Energy consumptions of construction equipment is are
Losses due to the construction process	Y	Full life cycle EPD include losses due to the construction process.
Waste management processes of other wastes generated on the construction site	Y	Full life cycle EPD include waste generation and management due to the construction process.

Table 6: construction phase

As mentioned in EN 15978 standard, manufacturing impacts of capital goods and transport of persons to and from the site are not included.

3.4.3. Use phase (B1 to B7)

During the use phase, in accordance with EN 15978, the assessment will cover the following points regarding energy and water uses:

- heating;
- cooling;
- ventilation;
- domestic hot water;
- lighting.

Maintenance of the cooling system in Part A is taken into account in the environmental assessment through refrigerant fluids leakage. The activities-related consumptions (if any) are not taken into account in the study. However, the impact of internal loads is included to assess the heating and cooling needs of the building in the thermal simulation.

3.4.4. End of life phase (C1 to C4)

Cf section 3.3.

4. Reference buildings presentation

4.1. Part A: Commercial building

4.1.1. General presentation

4.1.1.1. DOE reference building

Due to the lack of reference commercial buildings models in Europe, the definition of the reference building is based on the work carried out by the U.S. Department of Energy. Indeed, by consensus between DOE, the National Renewable Energy Laboratory, the Pacific Northwest National Laboratory and Lawrence Berkeley National Laboratory, fifteen commercial building types and one multifamily residential building were defined. Altogether, they represent approximately two thirds of the U.S. commercial building stock. Reference buildings provide a starting point to assess energy efficiency measures.

A “Stand Alone Retail” reference building will be used for the purpose of this study.

Several changes were applied to the reference building, particularly on HVAC installations, in order to better match the European context. The thermal envelope was also adapted to the requirement of the study.

Drawings, schemes and internal material definition were added as they are required for our LCC and LCA analysis.

4.1.1.2. Stand alone retail

The stand alone retail is a non food retail building with a gross area of about 2300 m². This type of commercial building could for example include DIY stores, clothing or appliances stores, etc.

As stated in the previous chapter, the scope of the study is limited to the building and its related consumptions. Thus, all the installations and consumptions related to activities are excluded.

The retail building is composed of 7 rooms and 5 thermal zones as shown on the pictures below. A technical room and toilets are included in the thermal zone “Back space”.

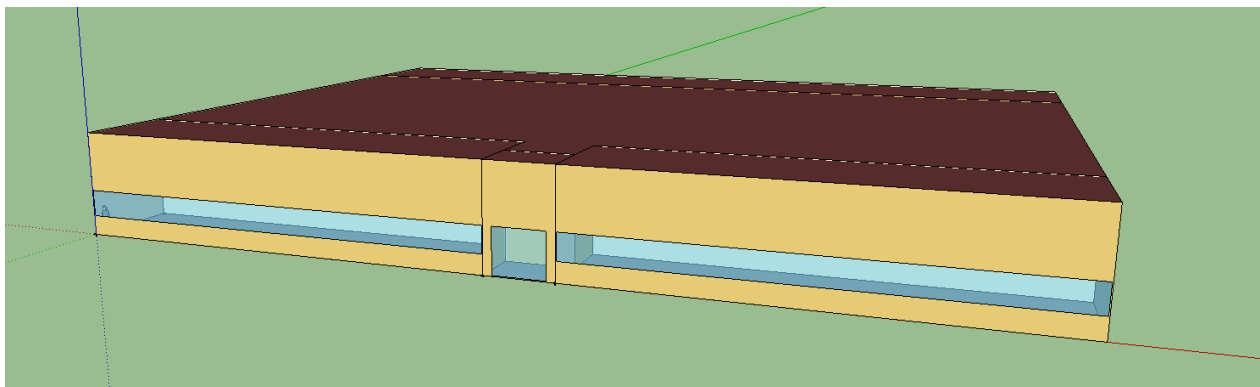

Figure 4: 3D view of commercial reference building

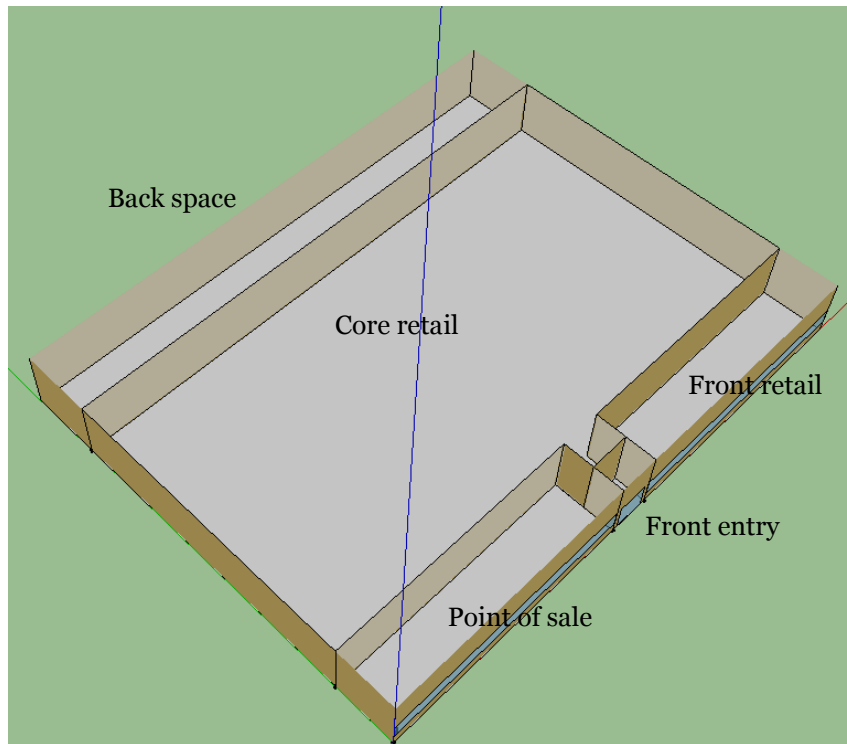

Figure 5: 3D view of the 5 thermal zones

4.1.2. Thermal performance and energy consumptions

The table below summarizes energy consumptions for the three climates.

Annual heating and cooling consumption

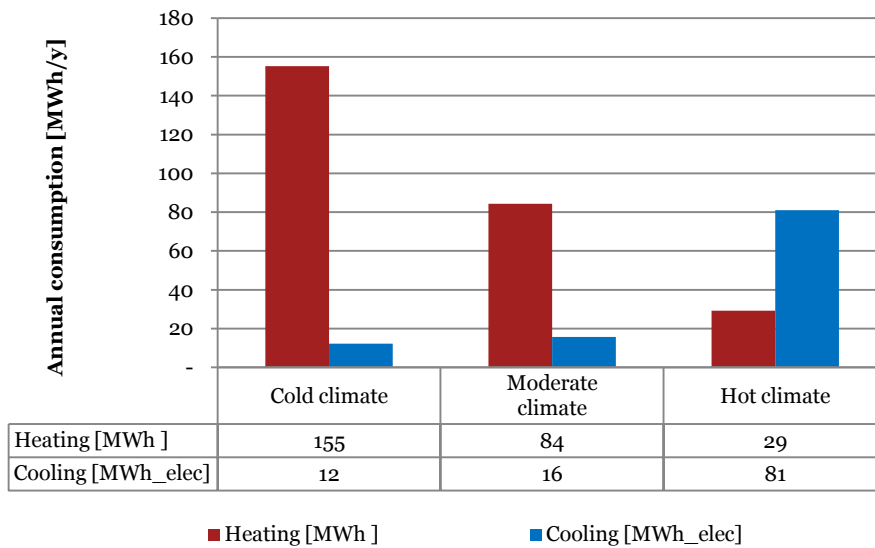

Figure 6 - Heating and cooling consumptions

4.2. Part B: Residential building

4.2.1. General presentation

4.2.1.1. Reference Building

The reference building geometry has been defined by the BRE in a previous LCC and LCA study (see *Life cycle environmental and economic analysis of polyurethane insulation in low energy buildings*, BRE Global, March 2010).

The small detached house is representative of a typical European dwelling. Some minor changes were made to the building: the thermal envelope was adapted to the requirements of the current study and the hipped roof has been modified into a standard pitched roof (2 faces).

Drawings, schemes and internal material definition have been added as they are required for our LCC and LCA analysis.

4.2.1.2. Small detached house

The dwelling is a 3-bedroom, 5-person and two-storey (+ attic) detached house, with masonry cavity walls, solid concrete floors and a pitched roof.

The scope of the study is limited to the building and its related consumptions. The building has been divided into three thermal zones. Each of these zones is heated. The attic, which is situated under the roof insulation, is thermally protected and is also heated. The pictures below are extracted from Open Studio, the thermal simulation software.

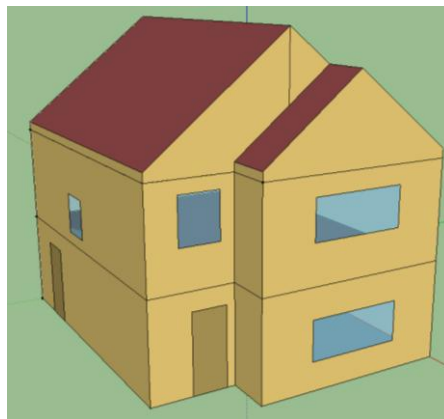

Figure 7: residential reference building

4.2.2. Thermal performance and energy consumption

The pitched roof refurbishment leads to a decrease of 14% in energy consumption (DHW excluded). The reduction would have been more important without an existing insulation layer. The existing walls and slab are not well insulated and also lead to important heat loss. Moreover, heat losses through thermal conduction are not the only one: infiltrations and ventilation also cause heating needs.

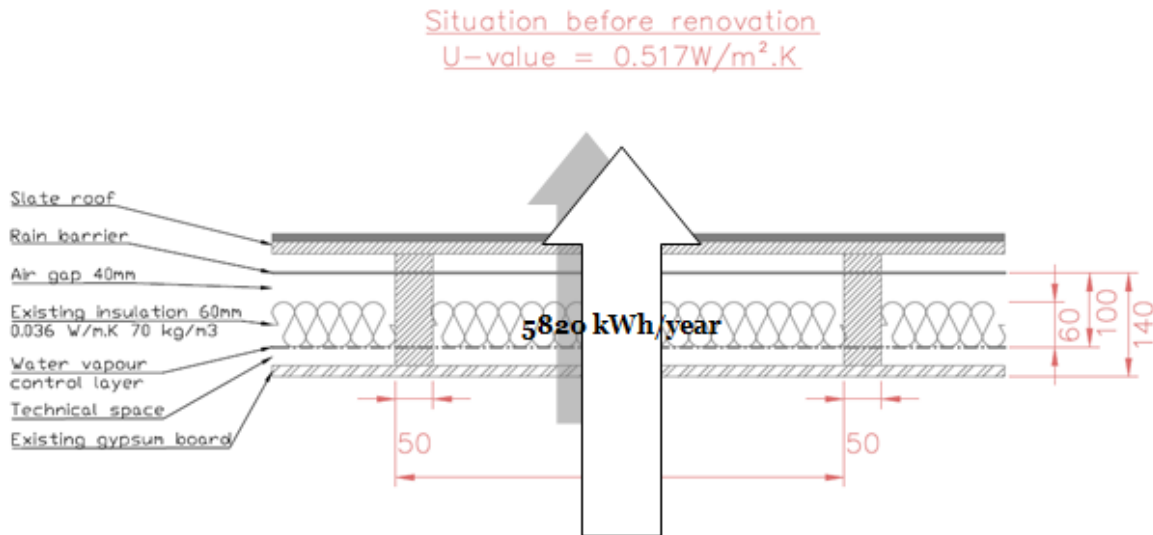

Figure 8: heat losses before refurbishment (roof only)

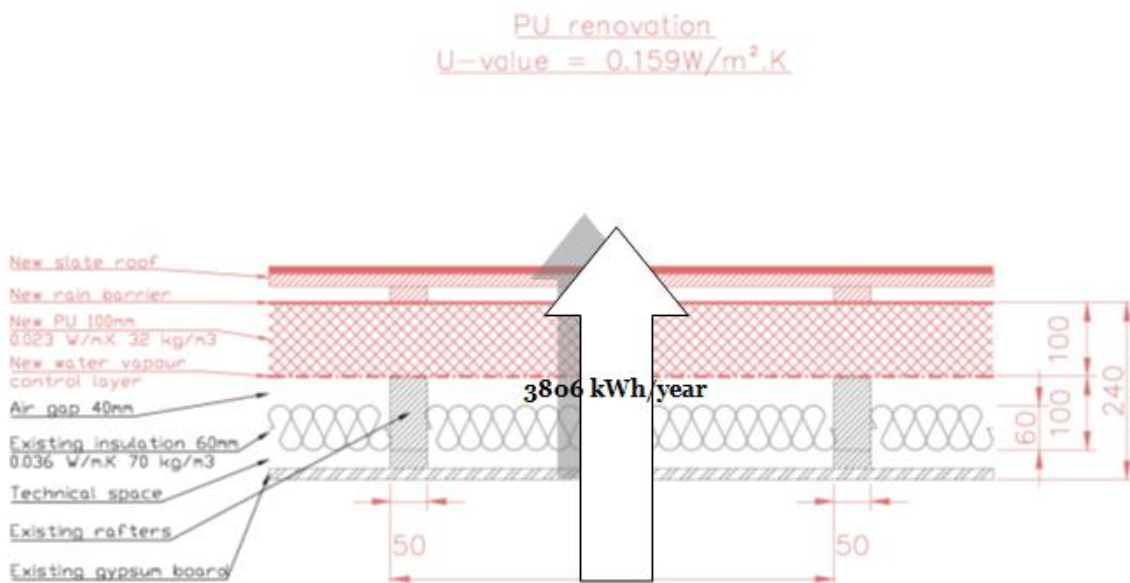

Figure 9: heat losses after refurbishment (roof only)

Annual data	Annual gas consumption BEFORE refurbishment [kWh]		Annual gas consumption AFTER refurbishment [kWh]	
Heating	20128	100%	17294	86%
DHW	3683	100%	3683	100%
Total	23811	100%	20978	88%

Table 7 – gas consumption, before and after refurbishment

5. Specific assumptions for assessment of economic performance

The LCC analysis is based on the EN 15643-4 standard: Framework for the assessment of economic performance. The scope of the study, in accordance with ISO 15686-5, is a life cycle cost, and not a whole life cost. Only the construction, operation, maintenance and end of life costs are taken into account. The important definitions are listed in Appendix O. -LCC definitions. The functional equivalents, the scenarios and the system boundaries are described in sections 3.2, 3.3 and 3.4 respectively.

For part A, the construction year is 2012. The results are expressed in 2012 discounted costs.

For part B, the construction year of the house is 1997, the refurbishment year 2012 and demolition year 2062. The results will be expressed in 2012 discounted costs.

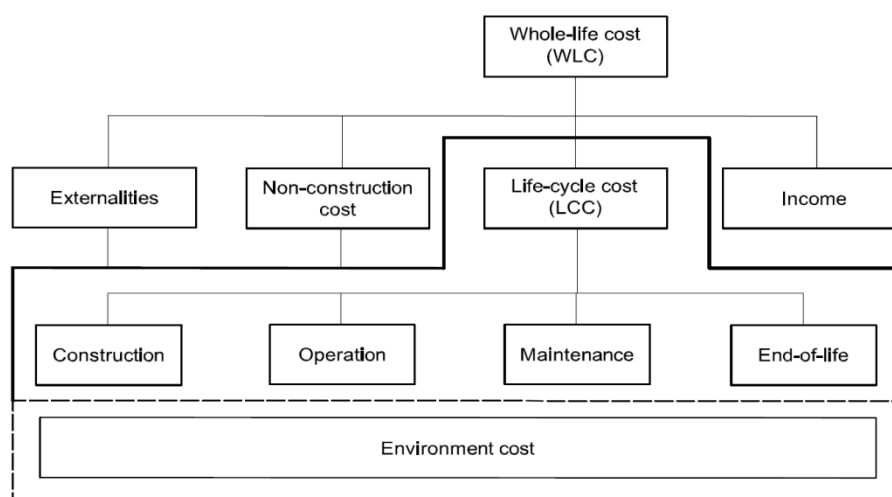

Figure 10 – life cycle cost scope (ISO 15686-5)

The risk and the difficulty of such a study essentially arise from the assumptions and the interpretation made for the evolution of the different parameters. These will highly affect the life cycle cost of a project. In particular, the following aspects have a significant impact:

- changes in energy prices;
- changes in water supply and sewerage prices;
- inflation rate;
- discount rate.

The table below summarizes the assumptions made.

Discount rate	4 %
----------------------	-----

Inflation	2%
Water base price (2012)	Website of the city of Luxembourg: 2,25€/m ³ (supply) 2€/m ³ (sewerage)
Annual water supply and sewerage price increase	2%
Electricity base price (2007)	170 €/MWh
Electricity real price increase (excluding inflation)	$y = 2,4786 x - 4804,55$
Gas base price (2007)	60 €/MWh
Gas real price increase (excluding inflation)	$y = 0,5667 x - 1077,367$
Components lifetime	VDI 2067
Component prices	- BKI (generic data) - Commercial prices (detailed data)
Maintenance, repair and other operational costs	VDI 2067
End of life	- EC Guidelines 2012/C 115/01 - Previous studies data
Cost of land	BKI cost index

Table 8 – LCC assumption summary

6. Specific assumptions for assessment of environmental performance

6.1. LCA methodology used

The LCA methodology for buildings is specifically described in the EN standards 15643-2 and EN 15978. This methodology is based on two levels and types of data:

- at the products and materials level, LCA are conducted on the basis of the function that the building product shall perform, expressed as a declared or functional unit. LCA results are presented in Environmental Product Declarations (EPD), according to the EN 15804, the French NF P 01-010 or the ISO 14025 standards;
- at building level, LCA data of products are aggregated and additional elements (e.g. construction works, operational energy use...) are included, according in order to perform the functional equivalent of the building.

The consolidation of LCA data is realized via the tool Elodie, developed by the French Scientific and Technical Centre for buildings (CSTB), which helps produce detailed results as expected for the present study. Although it is dynamically linked to the French EPD database Inies, it also flexible enough to allow the user selecting its own data sources.

The overall methodology is described in Figure 11.

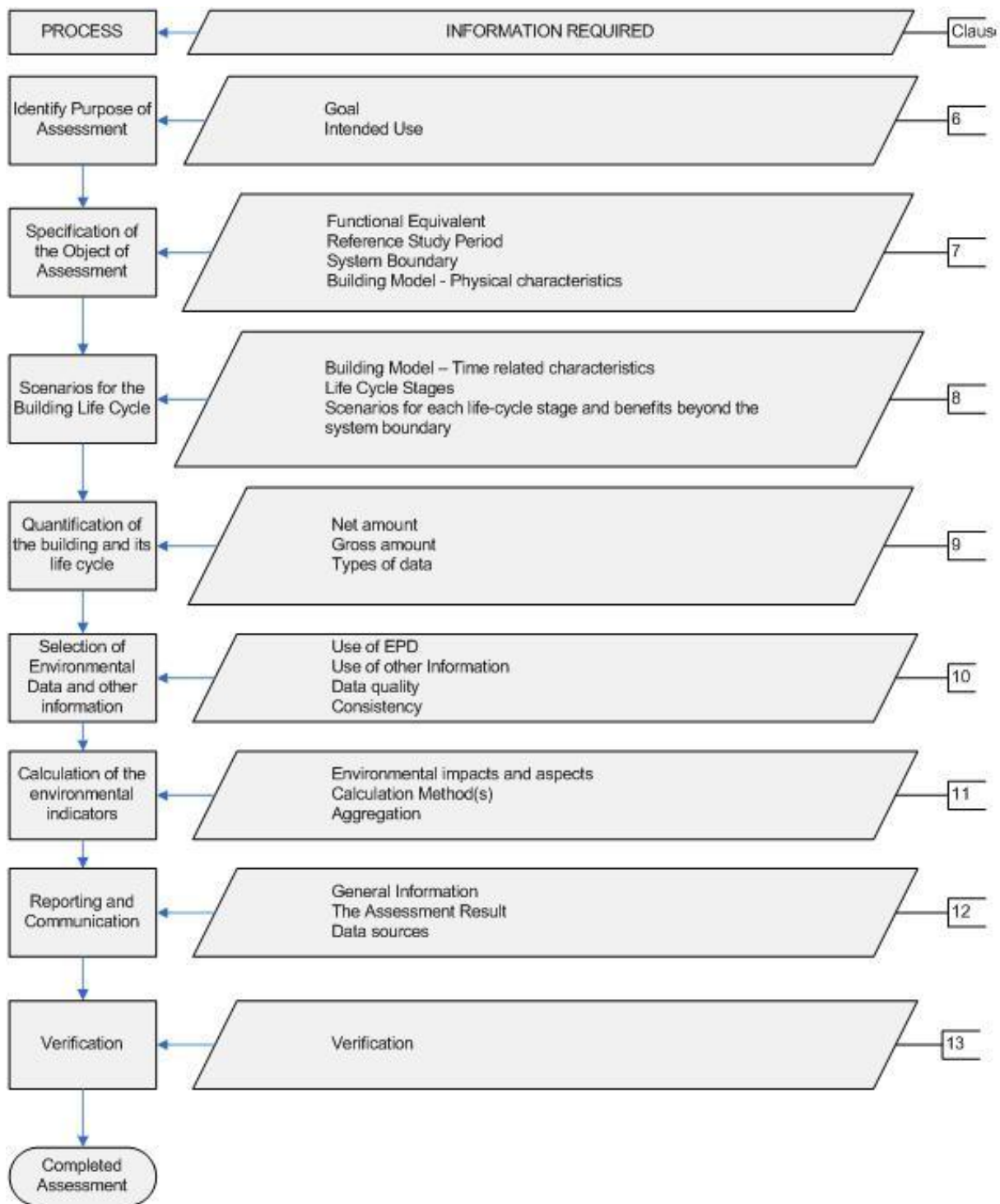

Figure 11 – Flowchart of the process for the assessment of the environmental performance, according to EN 15978

6.2. Functional equivalent

Cf section 3.2

6.3. Scenarios

Cf section 3.3

6.4. Selected environmental data

6.4.1. Data sources

6.4.1.1. Building products and materials

Detailed data sources for each building component are provided in Appendix D. -. Bill of quantities. The overall approach for the selection of environmental data is described below.

6.4.1.1.1. For components used in all scenarios

For generic components (i.e. all building components except insulating materials) French Environmental Product Declarations (EPDs) from the Inies² database are used for environmental impacts data sources. French EPDs are currently published according to the NF P 01-010 standard, which is not fully compliant with EN 15804. All EPDs have been selected after analyzing their consistency with the framework of the study: functional unit, system boundaries, data quality.

If EN 15804 EPDs were available, these sources have been selected.

6.4.1.1.2. For insulating materials

Concerning insulating materials, data from various European databases (mainly French Inies and German Institut Bauen und Umwelt³ (IBU) have been analyzed and representative EPDs have been selected.

Insulation material	Data source
Polyurethane (PU)	EPD from PlasticsEurope, according to EN 15804 standard. Specific EPDs corresponding to the required physical properties and scenarios have been generated from a tool set developed by PE International for PlasticsEurope.
Expanded polystyrene (EPS)	EPDs from EUMEPS
Wood fibre	Pavatex products are selected as they are covered by EPDs for light and dense boards from the IBU database. EPD by Gutex is used in sensitivity analysis
Glass wool Stone wool	See specific methodology to determine representative EPDs in Appendix P. -

Table 9 – Data sources for insulation materials

Two different insulation products of wood fibre are installed: a flexible board (low density) and a rigid board (high density). Pavatex provides EPDs for each kind of board whereas Gutex only provides an EPD for a rigid board. Thus the EPDs from Pavatex have been used in this study in order to deal with consistent data. A sensitivity analysis has been performed on the EPDs for the rigid board. The results are displayed in section 8.

N.B.: EPDs on Pavatex wood fibre products have been established considering a carbon neutral approach over the life cycle of the carbon which is captured, stored and finally released, and also avoided impacts related to the product's end of life. At the time of carrying out the present

² <http://www.inies.fr>

³ <http://bau-umwelt.de>

study, discussions on the combination of such methodologies at different standard committees in EU member states have pointed out their non-compliance with EN 15804 standards. As officially available data, the concerned EPDs have been used, although results on climate change impact should be considered with caution.

6.4.1.2. Technical equipments

Ideally environmental impacts related to technical and sanitary equipments are sourced from EPD and if not available, from Product Environmental Profiles (PEP Eco Passport⁴). When no PEP is available, the equipment is modeled on the basis of the main constitutive materials (e.g. kg of steel, copper, ceramics), with an increasing end conservative factor (10%) for processing. This approach must be fine tuned according to their relative contribution to the results.

HVAC equipments may have significant impacts on climate change at use stage, due to coolant gas leakage. The amount of leaking coolant gas during the whole life cycle has been estimated to be 0.1% per year of total mass of refrigerant liquid in the system. Global warming potential related to this leakage has been included in the LCA calculations.

6.4.1.3. Energy consumption

The building being theoretically located in Europe, an average European electricity mix has been considered for all scenarios. And a typical European mix of gas consumption from different sources (Algeria 12.5%, Germany 7.95 %, Netherlands 44.32 %, Norway 10.23% and Russia 25%) has been used.

6.4.2. Lifespan of building products

Lifespan of building products has been considered according to VDI 20-67. See Appendix D. - “Bill of quantities” for more details.

6.4.3. Data quality, completeness and consistency

Most of the LCA data used are based on EPDs and are representative of average construction products, which is consistent with the approach chosen for the study. Risks of inconsistencies between different types of EPDs have been minimized as:

- environmental impacts, which were not fully consistent have been excluded from the analysis,
- sensitivity analysis have been used to characterize the potential variations due to the selection of data,
- externally verified EPDs have been preferred when available.

6.5. Selected environmental impact indicators

The environmental impacts indicators have been selected, as far as possible, as required by EN 15978 and EN 15804 standards.

Indicator name	Unit	Characterization method
Climate change	GWP 100 kg CO ₂ eq	IPCC 2007 (GWP 100)

⁴ <http://www.pep-ecopassport.org>

Acidification	AE	kg SO ₂ eq	CML 2000 (Accumulated Exceedance)
Photochemical ozone formation	POCP	kg Ethene eq (C ₂ H ₄)	WMO 1999

Table 10 – Selected environmental impact indicators

Other selected environmental flows are as follows:

Indicator name	Unit
Input of non-renewable energy, primary energy (including feedstock)	MJ, net calorific value
Input of total primary energy (including feedstock)	MJ, net calorific value
Hazardous waste to final disposal	kg
Non-Hazardous waste to final disposal	kg
Radioactive waste to final disposal	kg

Table 11 – Selected environmental flows

Excluded indicators (from EN 15978):

- **Ozone depletion:** important discrepancies are observed amongst the different LCA data used for electricity production in the EPDs. French EPDs do not account CFC emissions, whereas EPDs for PU and wood fibre rely on other LCA models with CFC emissions from electricity production.
- **Eutrophication (aquatic):** This indicator being not available for all building components or products, interpretation of the results are not provided in the present study.
- **Abiotic depletion:** in EN 15978 and EN 15804 standards, abiotic depletion is split between elements and fuels, which is not the case in French EPDs. In addition, EPDs for wood fibre products do not provide data for this indicator. However, Abiotic resource depletion is partly expressed via the non-renewable primary energy consumption (including nuclear power).
- **Net fresh water:** definition of NET fresh water consumption is not robust enough and consistent in the existing databases. Either total or net water consumption may be accounted in the EPDs.
- Output flows leaving the system (components and materials for reuse, exported energy)
- Input of secondary materials, renewable and non-renewable secondary fuels.

6.6. Results display

Contribution of building components per life cycle stage was not available as most LCI data at product level were not published according to the EN 15804 standard. However, distinction between the differing contributions is displayed as far as possible in the Results interpretation.

In the following figures, building components are gathered within the categories, as described in the table below.

Building component	Shell, core & finishing
310 Excavations	Shell, core & finishing
320 Foundations	Shell, core & finishing
331 Loadbearing external walls	Shell, core & finishing
334 External doors and windows	External openings
335 External wall insulation	Insulation
335 Cladding units	Shell, core & finishing
335 Sandwich panel	Insulation
336 Internal linings	Shell, core & finishing
340 Internal walls	Shell, core & finishing
341 Loadbearing internal walls	Shell, core & finishing
350 Floors and ceilings	Shell, core & finishing
360 Roofs	Shell, core & finishing
363 Roof insulation	Insulation
363 Metal stud	Insulation
364 Roof linings	Shell, core & finishing
410 Sewerage, water and gas systems	Equipments
420 Heat supply systems	Equipments
430 Air treatment systems	Equipments
440 Power installations	Equipments
450 Telecommunications and other	Equipments

Table 12 – components categories

7. Results interpretation

7.1. Part A

This section presents the results of environmental impacts and cost calculations over the life cycle of the commercial building in the first part. Results may represent either overall cost and impacts (building construction, use and maintenance, demolition) or relative contributions of the different life stages (building components and materials, energy and water use, refurbishment).

The costs description for the commercial building below refers only to the four scenarios for moderate climate:

- Wall in PU and roof in PU
- Wall in SW and roof in SW
- Wall in PU and roof in EPS
- Wall in SW and roof in EPS

Detailed costs for each scenario and each climate are however summarized in Appendix H. - to Appendix J. -.

7.1.1. Life cycle costs analysis

7.1.1.1. Overall costs

The summary graphs below show the costs breakdown between the different items for the moderate climate and for the “wall-PU & Roof-PU” scenario. Construction and energy costs represent the most expensive items with 33% and 31% respectively. Insulation materials costs are about 5% of the total construction cost.

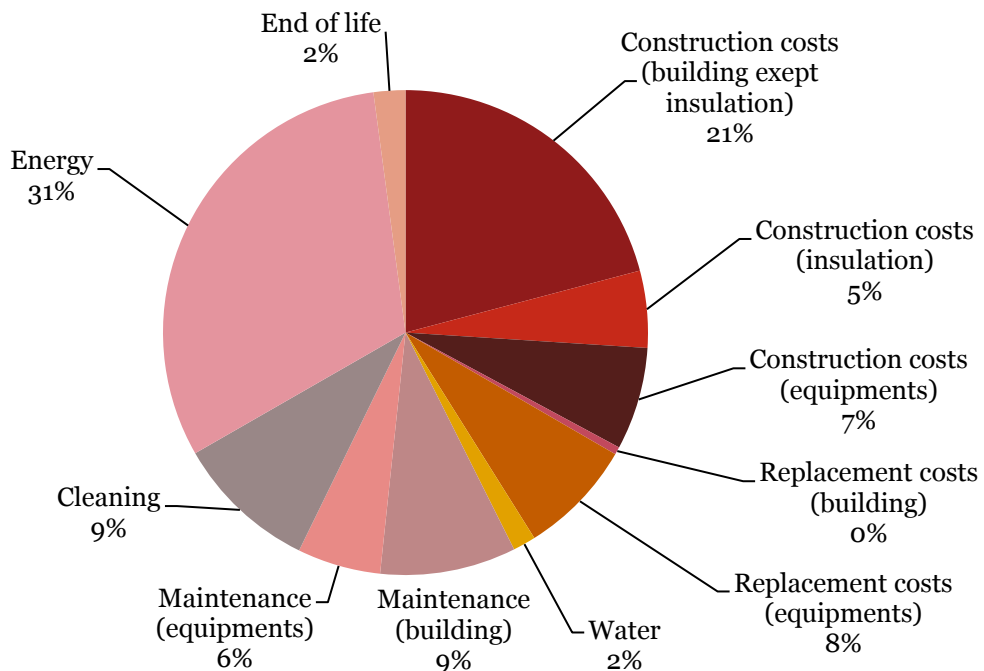

Figure 12 – Life cycle cost breakdown 1, Part A (2012 discounted €)

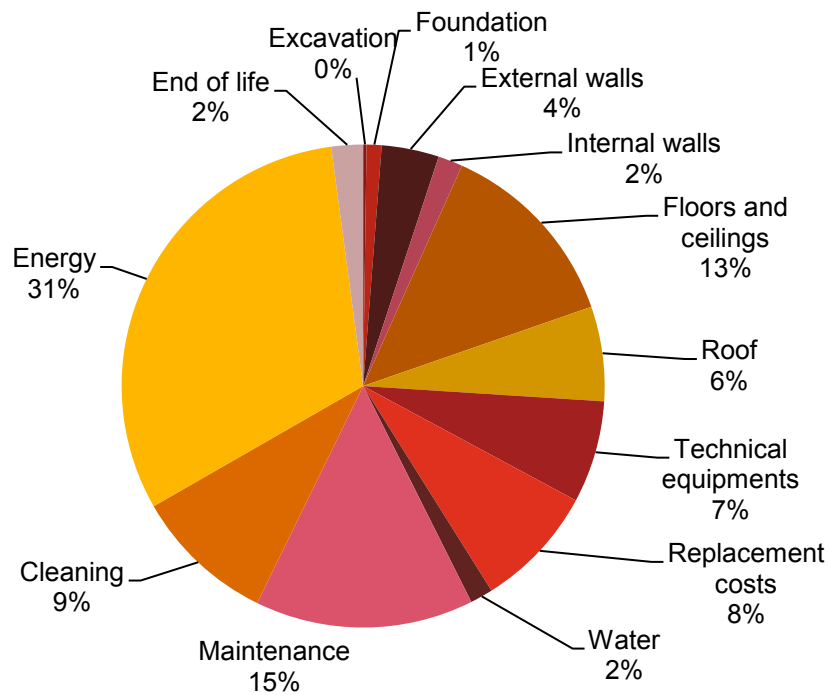

Figure 13 – Life cycle cost breakdown 2, Part A (2012 discounted €)

Total costs for each scenario of the moderate climate are roughly equivalent. The differences in total costs are very small (Figure 14 – Total costs, Part A) and could be explained by the uncertainties on real market prices. The choice of insulation material has thus a limited impact over the cost of the building. The cumulated annual costs reach 5 095 000 € for the “wall-PU & Roof-PU” scenario.

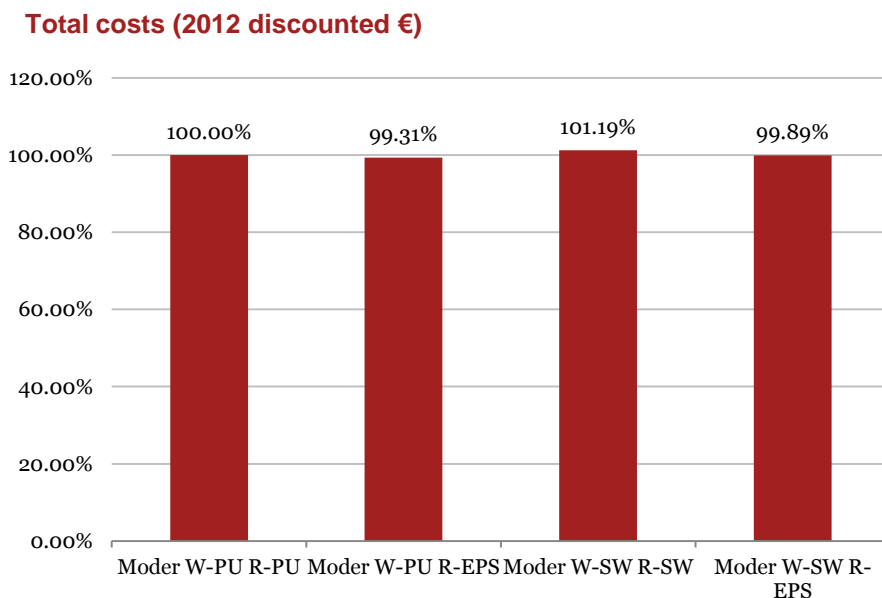

Figure 14 – Total costs, Part A

7.1.1.2. Construction costs

The construction costs have been taken from BKI – Kostenplaner software. Sandwich panels and other insulation material costs have been more precisely assessed and are based on commercial prices (for details, see Appendix H. -). Figure 15 shows the costs breakdown for the moderate climate, “wall-PU & roof-PU” scenario.

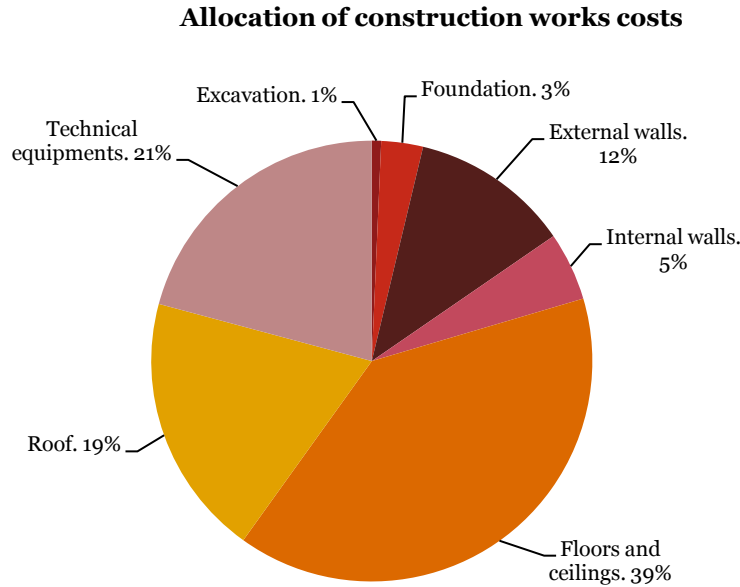

Figure 15 – Construction costs, Part A

	Construction costs
Moder W-PU, R-PU	1668282 €
Moder W-PU, R-EPS	1642470 €
Moder W-SW, R-SW	1713141 €
Moder W-SW, R-EPS	1664167 €

Table 13 – Construction costs, Part A

Some specific construction costs are also presented hereunder. Figure 16 shows a comparison between construction costs for flat roof, for each climate and each type of insulation material used. Figure 17 shows the same comparison but for external walls construction costs. Flat Roof construction costs are the lowest with EPS insulation. PU scenario is more expensive but less than SW scenario. This is also true for walls construction costs.

Flat roof construction costs (2012 discounted €)

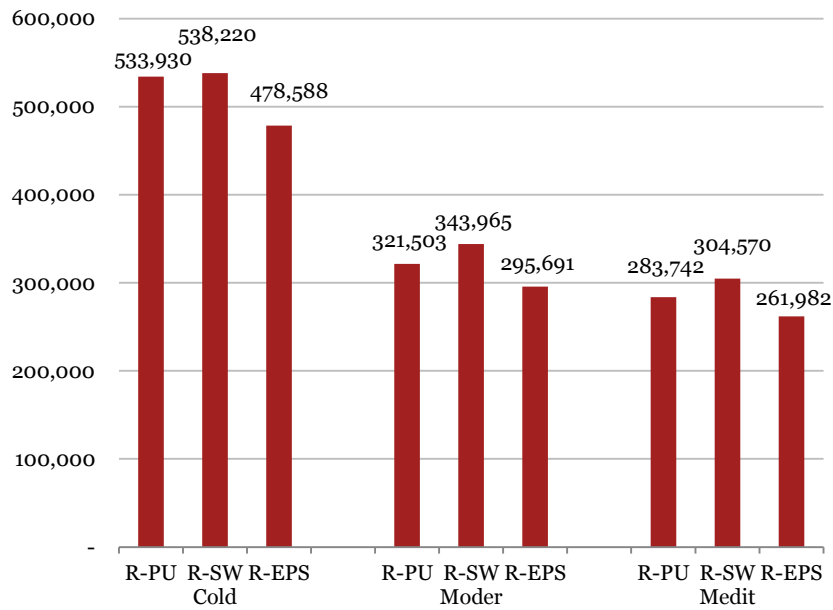

Figure 16 – Flat roof construction costs, Part A

Wall construction costs (2012 discounted €)

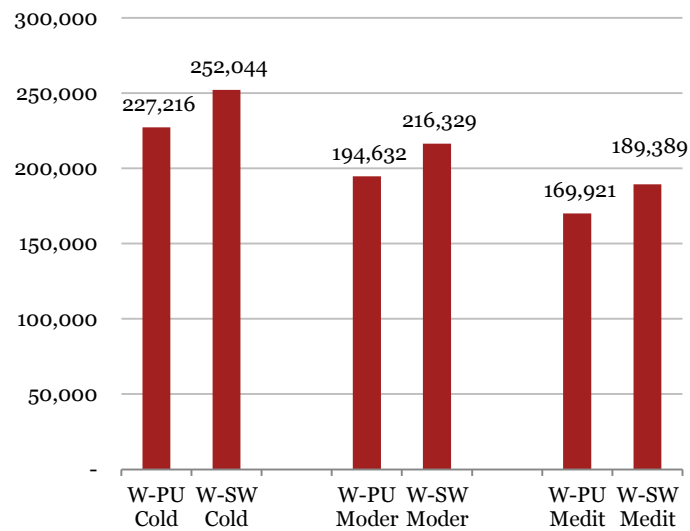

Figure 17 – Wall construction costs, Part A

The graph below compares the costs of steel frame (the complete steel structure as well as the trapezoidal roofing sheets) and insulation materials for all scenarios of moderate climate. We can notice that insulation materials are more expensive than the steel frame.

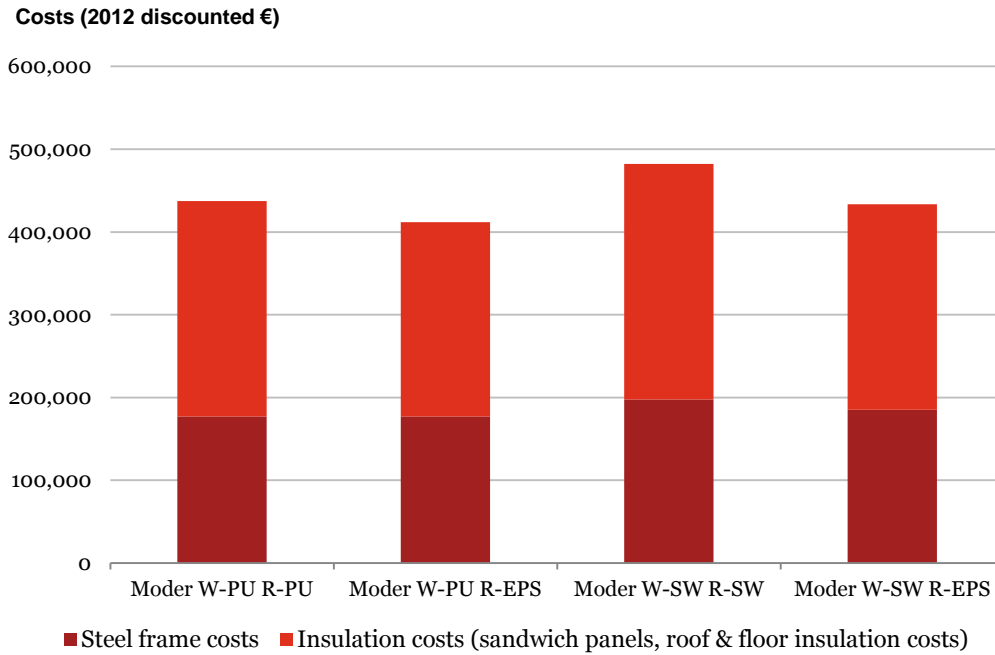

Figure 18 – Steel frame, sandwich panels & roof insulation costs

Steel frame, sandwich panels & roof insulation costs (2012 discounted €)

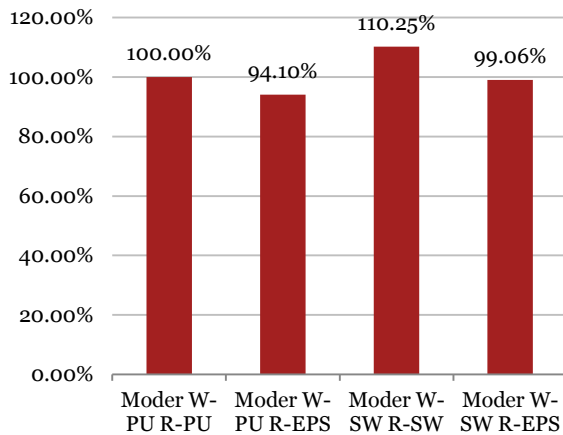

Figure 19 – steel frame, sandwich panels & roof insulation costs

Total Construction costs (2012 discounted €)

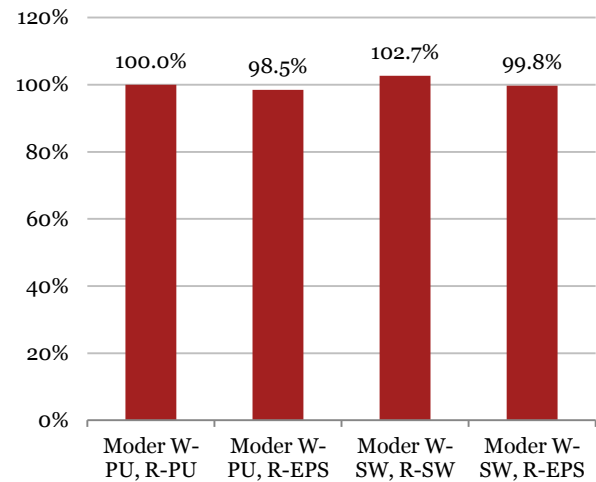

Figure 20 – total construction costs

For a given climate, the construction elements that differ from one scenario to another are the insulation materials and the steel structure. Considering only these elements (Figure 19), the “PU wall and EPS roof” scenario is the cheapest (5.9% cheaper compared to the reference scenario: “PU wall and PU roof”). The “SW wall and EPS roof” scenario is a bit cheaper than the reference scenario whereas the cost of the “SW wall and SW roof” scenario is about 10% above of the reference scenario. When considering all the construction costs

(Figure 20), the differences in costs abate and vary between -1.5% for “PU wall and EPS roof” scenario and +2.7% for “SW wall and SW roof” scenario.

7.1.1.3. Regular costs

During the life cycle of the building, regular costs arise from:

- water supply and sewerage;
- energy consumption (gas and electricity);
- maintenance.

7.1.1.3.1. Water

Annual fresh water consumption has been estimated at 574 m³ per year (see C.1 Building summary).

The life cycle cost takes into consideration the inflation rate of 2% and the discount rate of 4%.

Nominal cost at year n

$$C_{n+1} = C_n * (1+\Delta ea) = C_1 * (1+\Delta ea)^{n-1}$$

Discounted cost year n

$$V_n = C_n / (1+Ta)^n$$

Global life cycle cost:

$$\text{Global cost} = \sum_1^{30} V_n = \sum_1^{30} \frac{C_n}{(1+Ta)^n} = \sum_1^{30} C_0 \frac{(1+\Delta ea)^n}{(1+Ta)^n}$$

With $\Delta ea = 2\%$ and $Ta = 4\%$

Water costs [2012 discounted €]	
2012 costs	2440
Life cycle cost	210458

Table 14 – Water costs part A

7.1.1.3.2. Energy

Annual energy consumptions have been computed thanks to the thermal model (see section C.1.9). The energy prices have been discussed in the previous section.

In addition to the real price increase, the life cycle costs takes into account the inflation rate of 2% and the discount rate of 4%.

Nominal cost at year n

$$C_{n+1} = C_n * (1+\Delta ea) = C_1 * (1+\Delta ea)^{n-1}$$

Discounted cost year n

$$V_n = C_n / (1+Ta)^n$$

Global life cycle cost:

$$\text{Global cost} = \sum_1^{30} Vn = \sum_1^{30} \frac{Cn}{(1+Ta)^n} = \sum_1^{30} C_0 \frac{(1+\Delta ea)^n}{(1+Ta)^n}$$

With $\Delta ea = 2\%$ and $Ta = 4\%$

	2012 [2012 discounted €]	2013 [2012 discounted €]	Life Cycle [2012 discounted €]
Gas	5514	6309	241203
Electricity	27659	32571	1341665

Table 15 – energy costs part A (moderate climate)

The figures are identical from one scenario to another given that the same functional unit is achieved (same wall and roof U-values).

7.1.1.3.3. Maintenance

During the life cycle, the different components of the building are regularly serviced in order to maintain their levels of performance. In this context, we used VDI statistical data to evaluate the costs of the maintenance for each of the building parts.

These costs are divided into repairs and servicing costs.

The total annual costs for maintenance are calculated as follows:

$$E_{\text{annual}} = (\% \text{ repairs} + \% \text{ servicing}) * V$$

The inflation and discount rates are applied in the same way as in previous sections. For calculation details, see Appendix I. -.

	2012 [2012 discounted €]	2013 [2012 discounted €]	Life Cycle [2012 discounted €]
Moder W-PU, R-PU - building	14529	14820	460354
Moder W-PU, R-PU - equipments	8910	9088	282302
Moder W-PU, R-EPS - building	14245	14530	451358
Moder W-PU, R-EPS - equipments	8910	9088	282302
Moder W-SW, R-SW - building	15023	15323	475988
Moder W-SW, R-SW - equipments	8910	9088	282302
Moder W-SW, R-EPS - building	14484	14774	458919
Moder W-SW, R-EPS - equipments	8910	9088	282302

Table 16 – Maintenance costs part A

The maintenance costs do not vary for the equipments. They slightly differ for the building from one scenario to the other, due to the differences in the insulation materials prices.

7.1.1.4. Replacement costs

All equipments and structure that present a life span lower than the building service life will be replaced one or several times before the building end of life. The incurred costs are based on VDI statistical data. See Appendix J. - for more details.

	Life cycle cost [2012 discounted €]
All scenarios	25758

Table 17 – replacement costs shell core & finishing Part A

	Life cycle cost [2012 discounted €]
Cold climate - all scenarios	418834
Moderate climate - all scenarios	392182
Mediterranean climate - all scenarios	276272

Table 18 – replacement costs equipments Part A

7.1.1.5. End of life costs

All components of the building will be demolished at the building end of life. A ratio of 20 €/m³ has been considered to assess end of life costs.

	Life cycle cost [2012 discounted €]
All scenarios	107562

Table 19 – end of life costs Part A

7.1.2. Overall environmental life cycle analysis (LCA), at a glance

7.1.2.1. Overall results on the whole study period

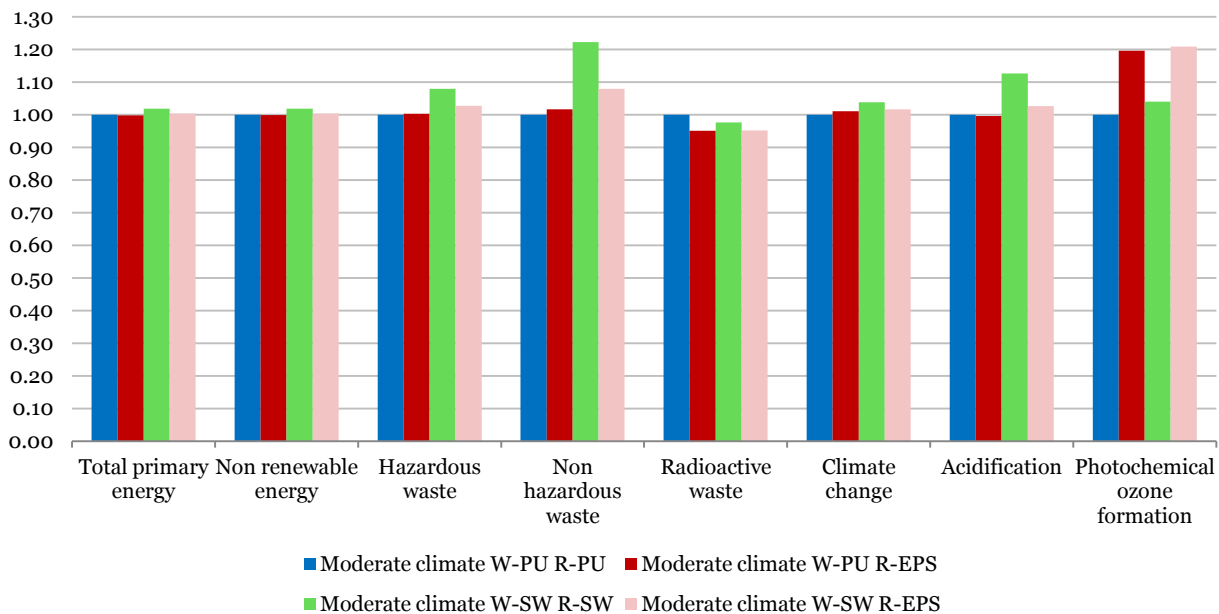

Figure 21 - Relative results on the whole study period (W-PU R-PU scenario being 100%)

For a majority of the indicators, there are no significant variations between the scenarios if we consider the whole study period: total and non renewable primary energy, hazardous and radioactive waste and climate change.

Some significant variations exist between scenarios for the indicator non hazardous waste and can be explained by the difference in the end of life treatment for the different insulation materials.

The higher impacts of EPS in terms of photochemical ozone formation can be noticed and are due to the emissions of pentane during the foaming process of polystyrene.

Differences inferior to 20% of the impact should be disregarded as they are insignificant acknowledging the threshold uncertainty assessed (see section 8.3 Limitations).

A sensitivity analysis has been performed in order to assess the impact of the study period on the overall results (see section 8.1 Sensitivity analysis for different study periods).

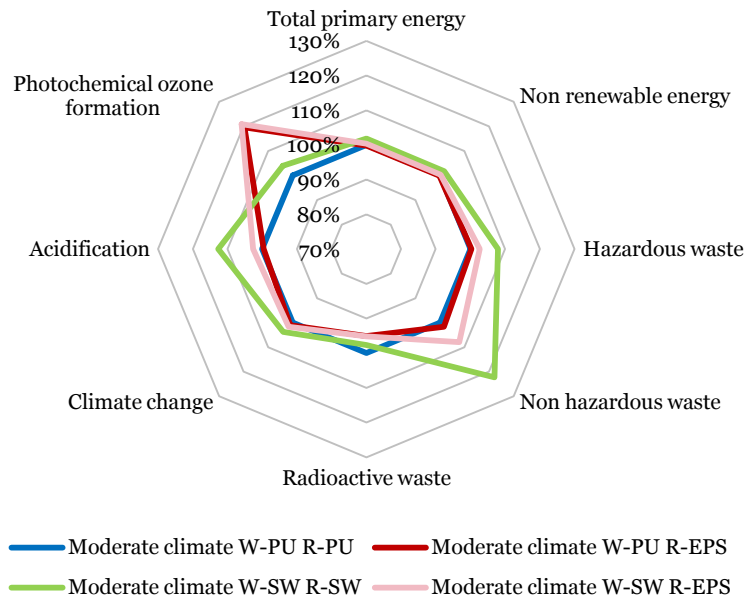

Figure 22 - Relative results on the whole study period (W-PU R-PU scenario being 100%)

Figure 22 reflects previous results for a limited number of indicators that have been selected considering both their particular relevance with regards to issues for construction and their reliability in the present study. W-PU R-PU scenario is also taken as reference.

In view of the threshold uncertainty of 20%, no scenario stands out if we consider the whole study period.

7.1.2.2. Overall results: components used for building construction

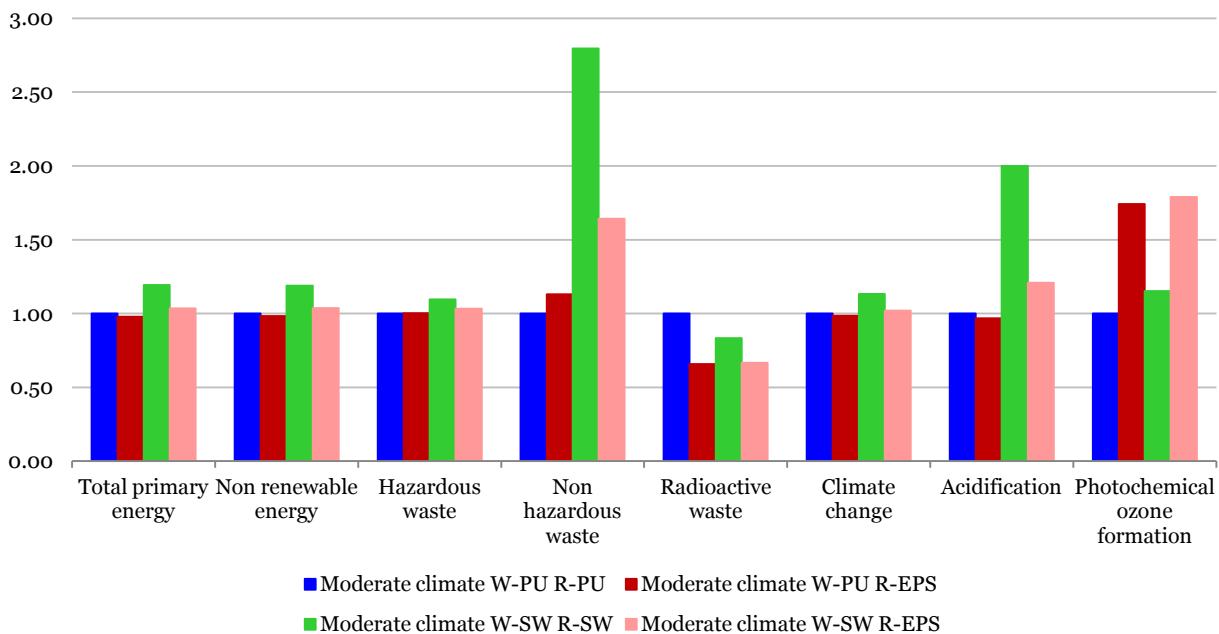

Figure 23 – Relative results for building components (W-PU R-PU scenario being 100%)

For the non hazardous waste, the relative high impact of the scenario W-SW R-SW is partly due to the fact that PU foam and EPS are incinerated at the end of life, which lowers the impact of the PU and EPS.

The relative higher impacts noticed in the scenarios where SW insulation is used, in terms of non renewable and total primary energy, non hazardous waste and acidification are partly counterbalanced with the use of EPS for the roof insulation.

Hereunder, Figure 24 shows the relative results for flat roof for the moderate climate and each type of insulation material used. Figure 25 shows the relative results for external walls.

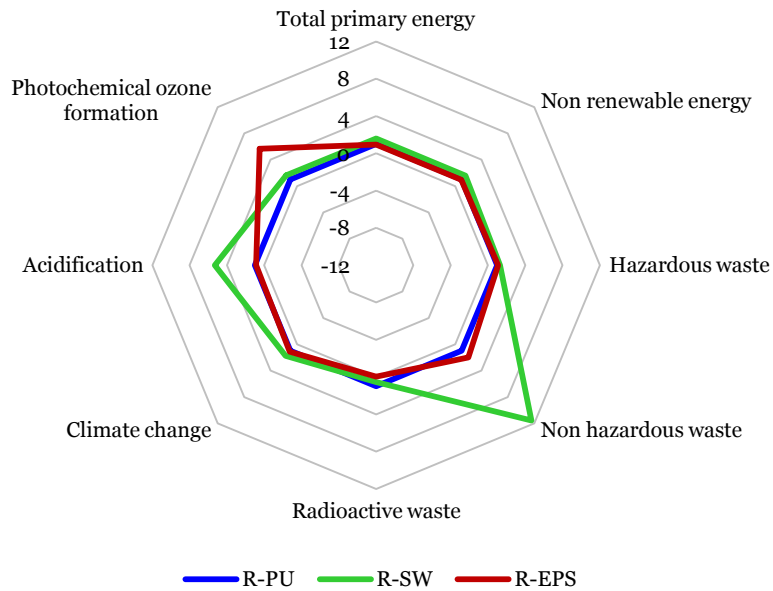

Figure 24 – Relative results for the roof (Moderate climate – R-PU being 100%)

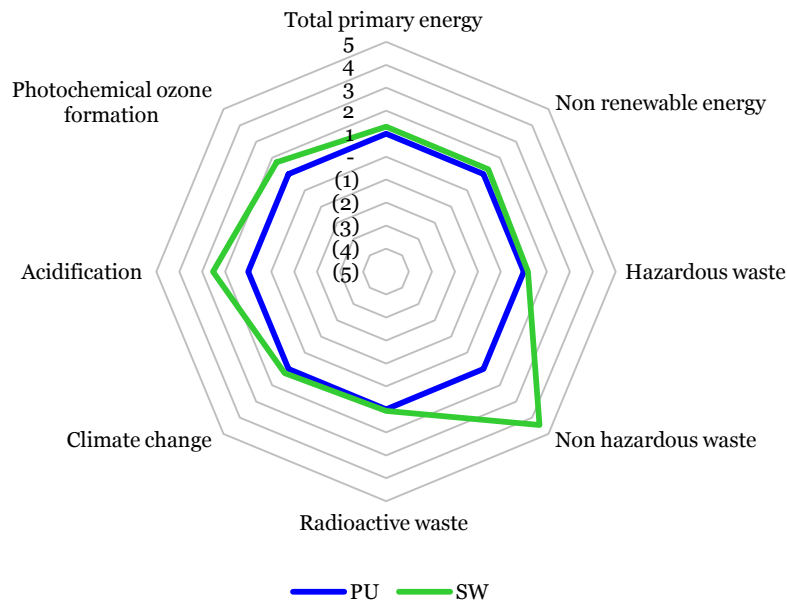

Figure 25 – Relative results for the wall (Moderate climate – W-PU being 100%)

7.1.3. Detailed LCA results per indicator

This series of figures display the results for each indicator selected considering both their particular relevance with regards to issues for construction and their reliability in the present study. Overall impacts on the 50-year study period are first presented for the moderate climate scenario in the form of a breakdown of the contributions per building component and per energy and water consumption during the use phase.

A comparison between the different climate scenarios is then displayed for each indicator selected.

7.1.3.1. Input of total primary energy (including feedstock)

Total primary energy (kWh/m²/an)

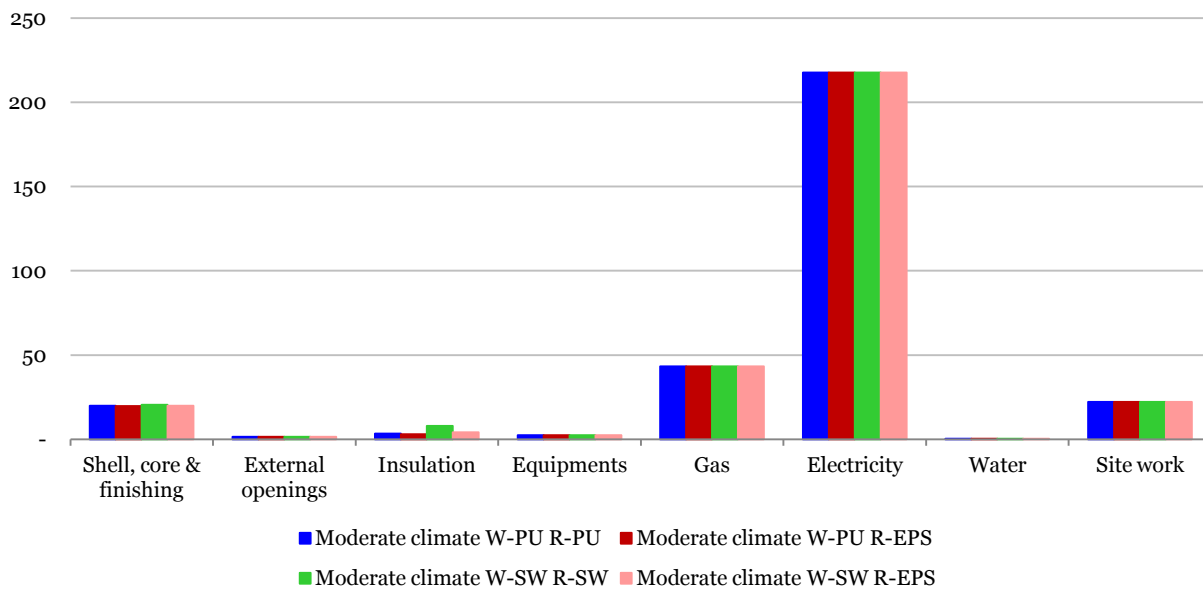

Figure 26 – Breakdown of total primary energy

Total primary energy (kWh/m²/an)

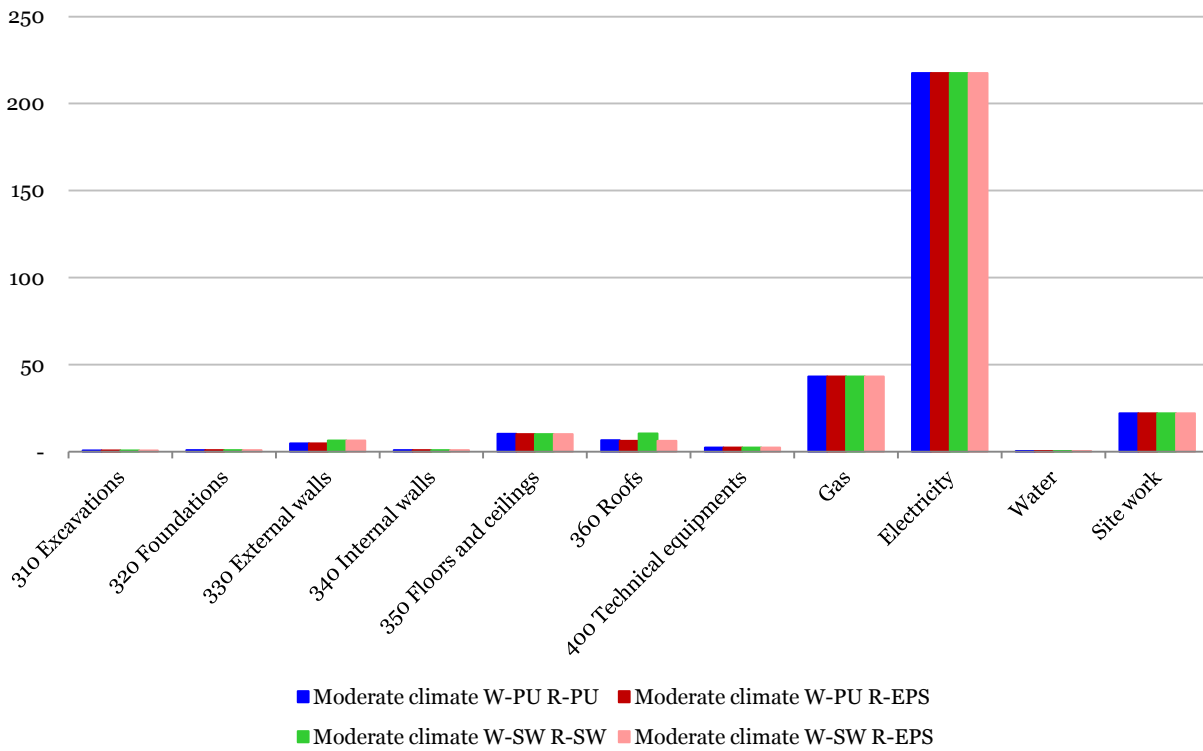

Figure 27 – Breakdown (2) of total primary energy

The impact of the building construction is relatively low - about 8 times lower - compared to those due to the energy consumption. The impact of the insulation is at least 30 times lower than those due to the energy consumption.

The consumption of total primary energy due to the insulation ranges from 1% to 2.7% of the impact of the building on the whole study period.

Total primary energy (kWh/m²/an)

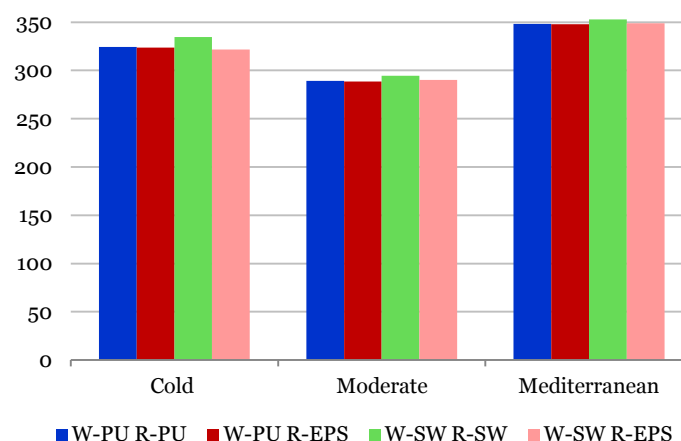

Figure 28 – Total primary energy on the whole study period for the whole study period (moderate W-PU R-PU scenario being 100%)

The ordering of the different insulation scenarios does not differ significantly from one climate to another.

NB:

- the impact of PU insulation considered per kg is higher than the impact of SW insulation considered
- the quantity of insulation needed in the PU scenario is relatively lower than in the SW scenario – *which counterbalances the effect of the higher impact of PU insulation per kg*

Total primary energy (kWh/m²/an)

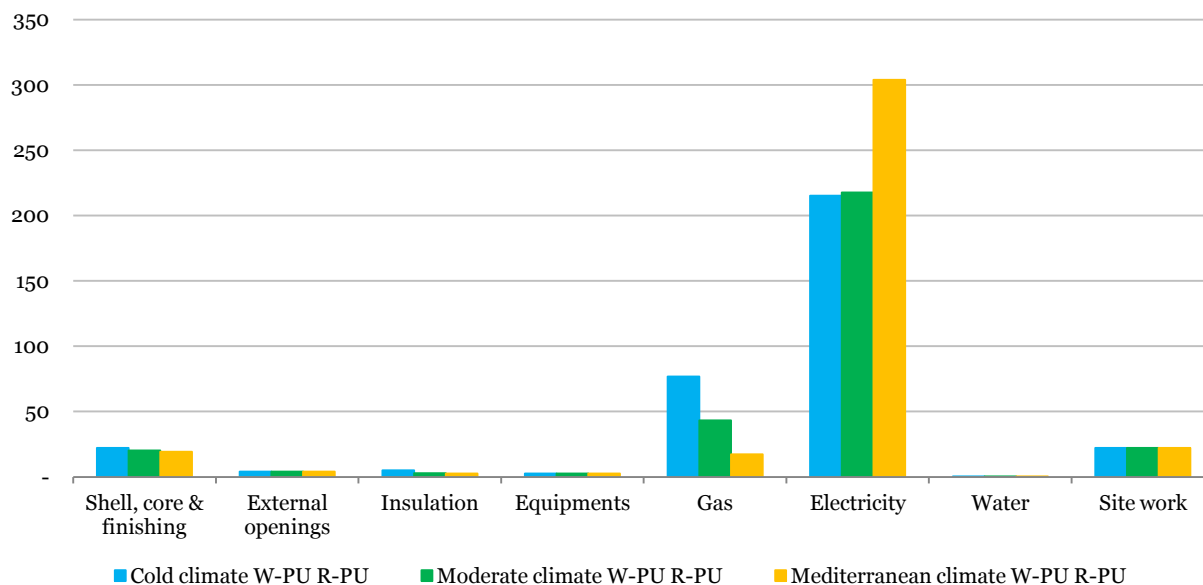

Figure 29 – Breakdown of total primary energy for the W-PU R-PU scenario for the different climates

The impacts of the building construction are relatively low compared to those due to the energy consumption during the use phase, **irrespective of the climate considered.**

This statement is worth for all the indicators.

7.1.3.2. Input of non-renewable primary energy (including feedstock)

Non renewable energy (kWh/m²/an)

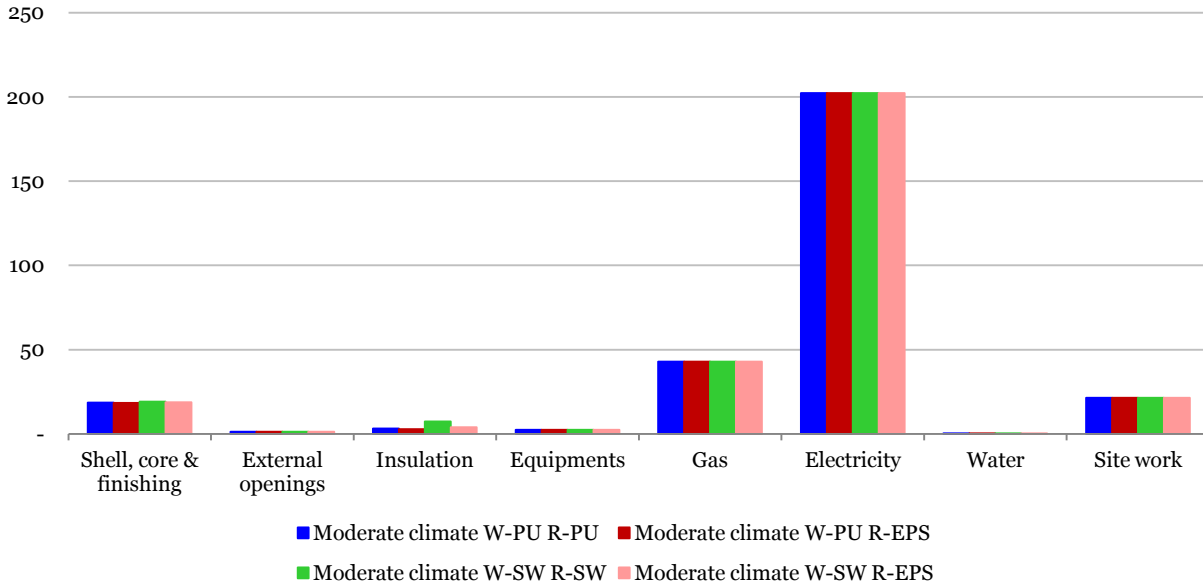

Figure 30 – Breakdown of non renewable energy

Non renewable energy (kWh/m²/an)

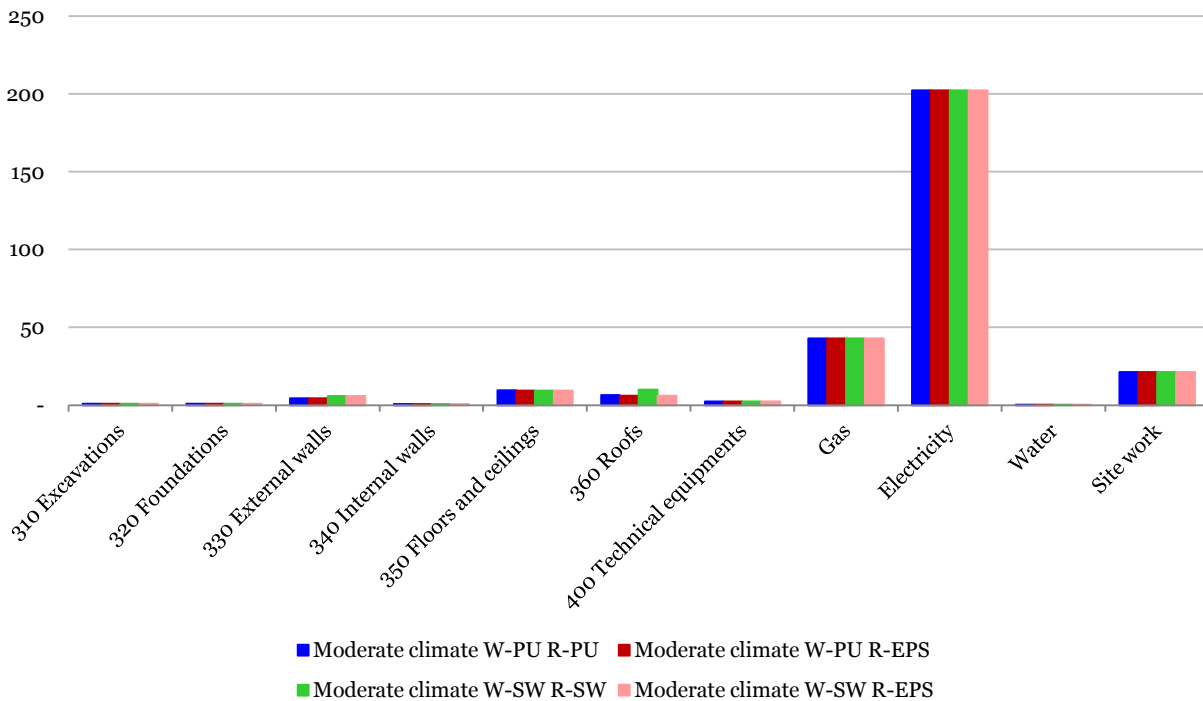

Figure 31 – Breakdown (2) of non renewable energy

The results for the consumption of non renewable energy are quite similar with those of the total primary energy consumption. The impact due to the insulation ranges from 1.1% to 2.7% of the impacts of the building on the whole study period. It is at least 30 times lower than the impact of the energy consumption.

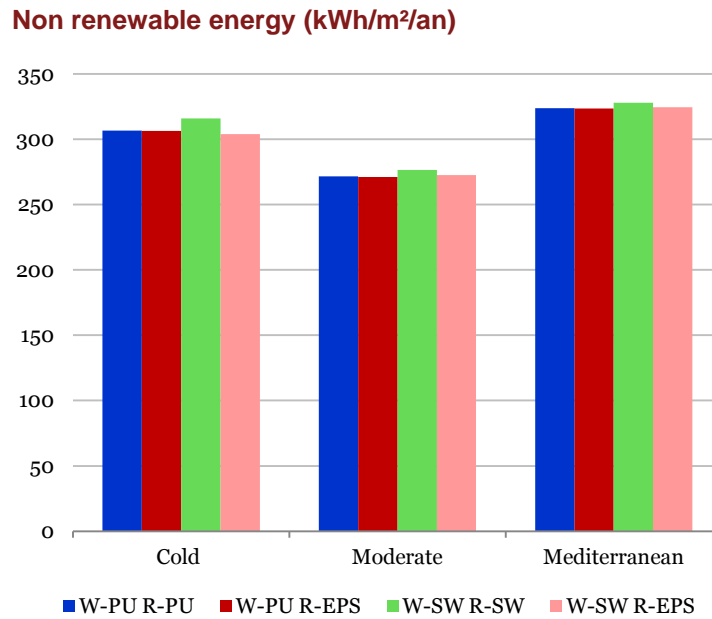

Figure 32 – Non renewable energy on the whole study period for the different climates

The display is similar to the one for total primary energy: it varies slightly from one climate to another, due to the fact that the variation in insulation weight between the different scenarios is higher for the Cold climate than for the others.

7.1.3.3. Climate change

Climate Change (kg eq. CO₂/m²/an)

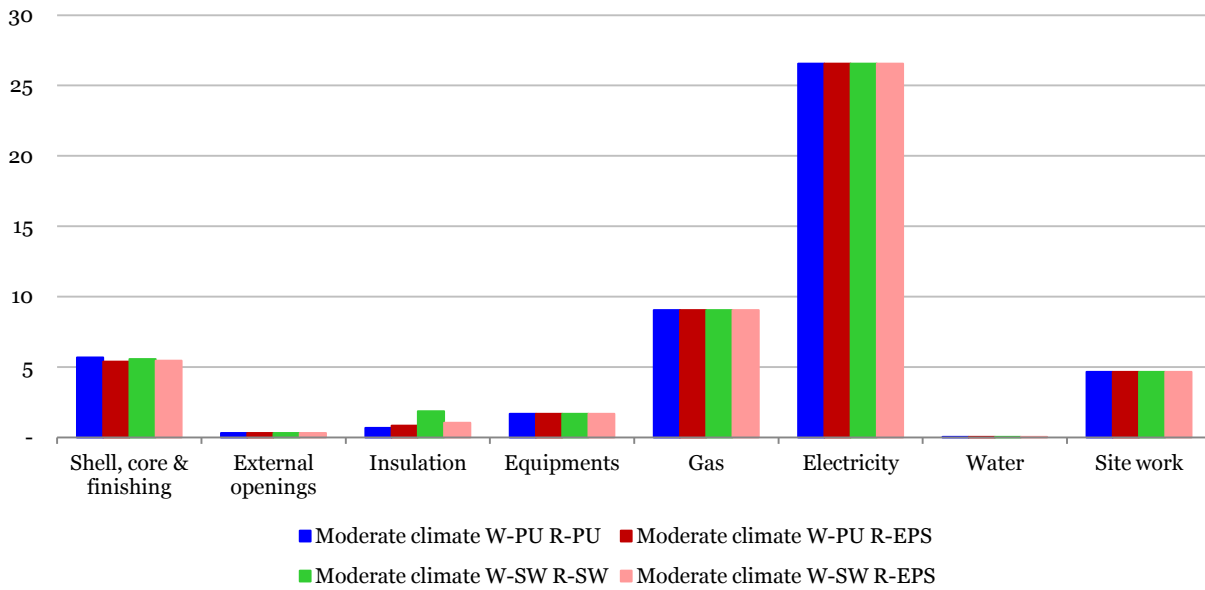

Figure 33 – Breakdown of climate change

Climate Change (kg eq. CO₂/m²/an)

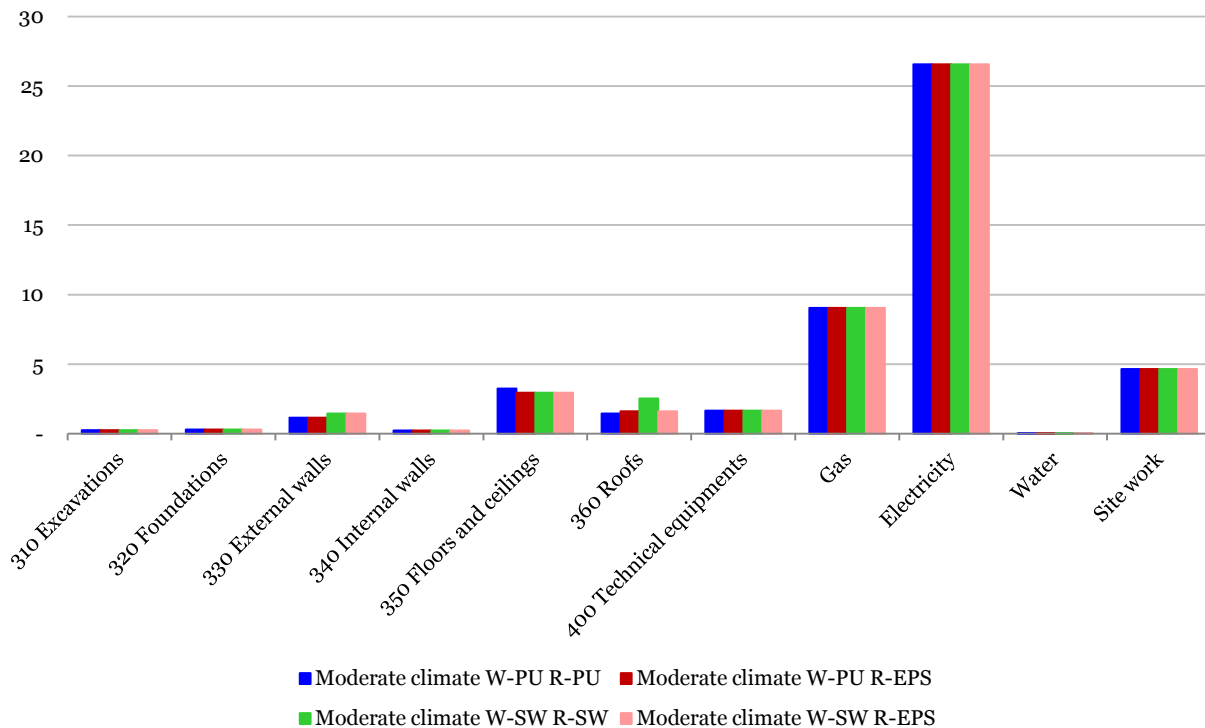

Figure 34 – Breakdown (2) of climate change

The impacts on climate change due to the insulation vary between 1.5% and 4.1% of the building's impacts and they are at least 20 times lower than the impacts due to the energy consumption.

At the building construction level, the contribution of the insulation to the impact on climate change ranges from 8.1% to 19.8% of the building component's impact.

The contribution of the equipments is relatively higher for this indicator compared to the previous ones related to energy consumption, as refrigerant leakage is considered in this study only in terms of CO₂ emissions.

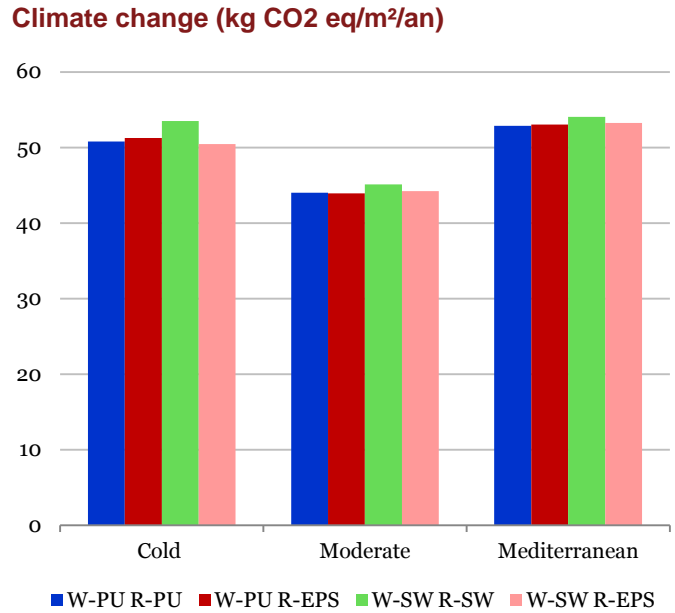

Figure 35 – Climate change on the whole study period for the different climates

The display is quite similar to those for non renewable and total primary energy.

7.1.3.4. Acidification

Acidification (kg SO₂ eq/m²/an)

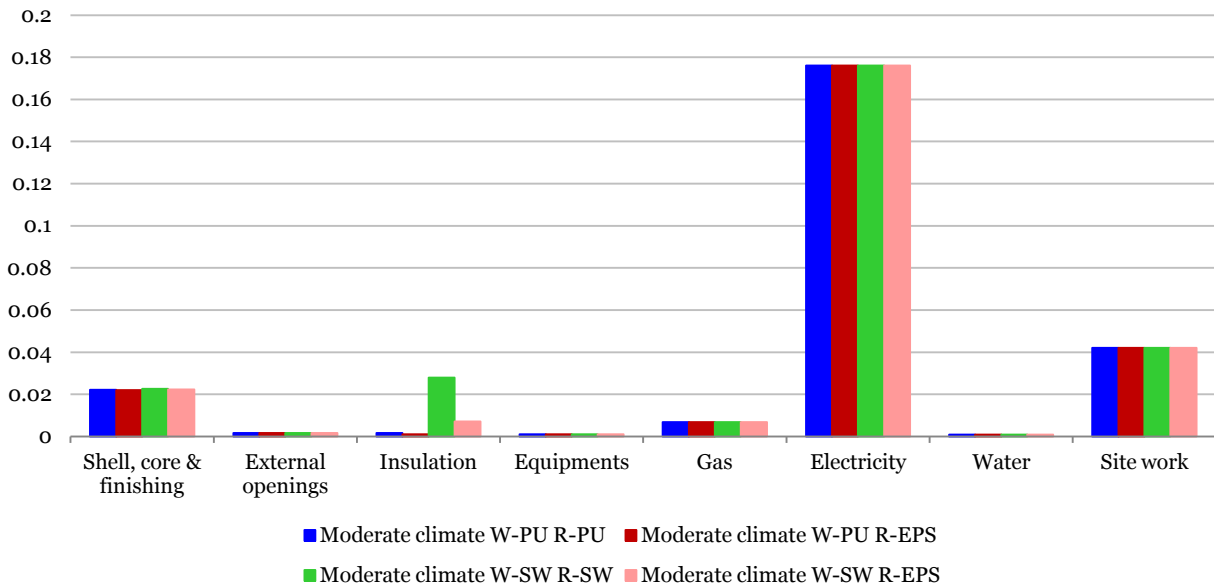

Figure 36 – Breakdown of acidification

Acidification (kg SO₂ eq/m²/an)

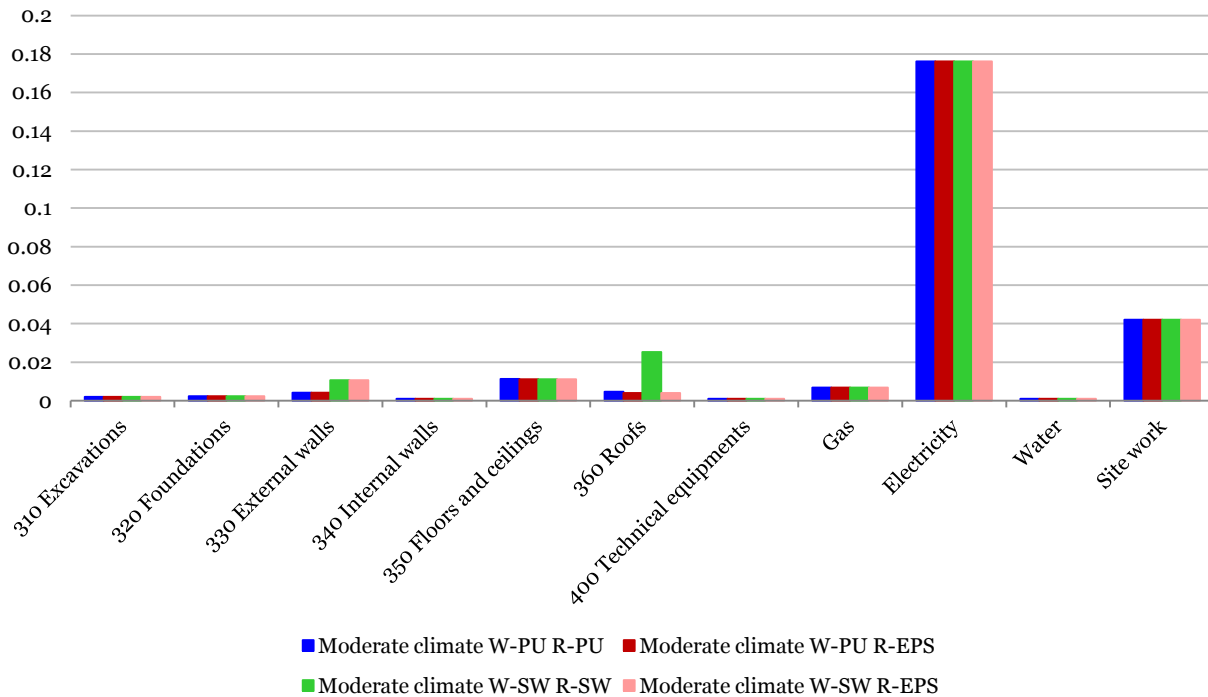

Figure 37 – Breakdown (2) of acidification

The scenario where SW insulation is used present higher impacts in terms of acidification.

The impact of the insulation represents almost 50% of the building components' impacts and is only around 7 times lower than the impacts due to the energy consumption for the scenario W-SW R-SW whereas it represents 3% to 6% of the building components' impacts and is at least 100 times lower than the impacts due to the energy consumption for the scenario W-PU R-PU and W-PU R-EPS.

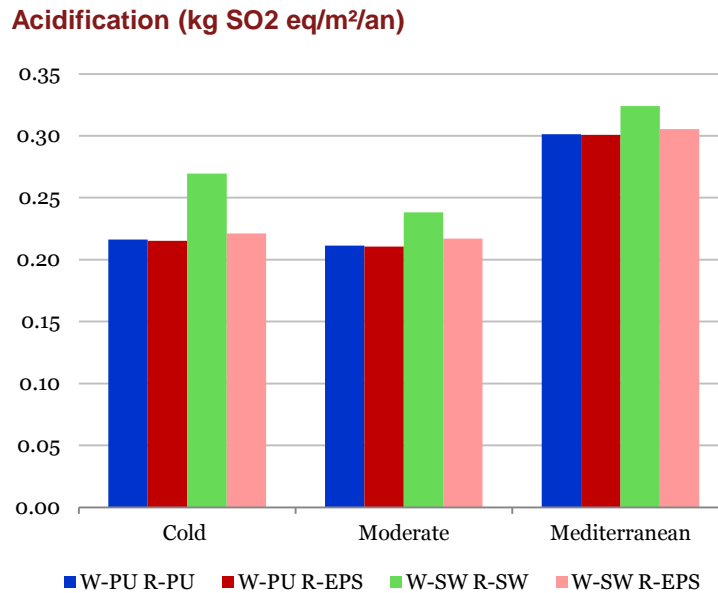

Figure 38 – Acidification on the whole study period for the different climates

The different insulation alternatives display the same order irrespective of the climate considered.

7.1.3.5. Hazardous waste to final disposal

Hazardous waste (kg/m²/an)

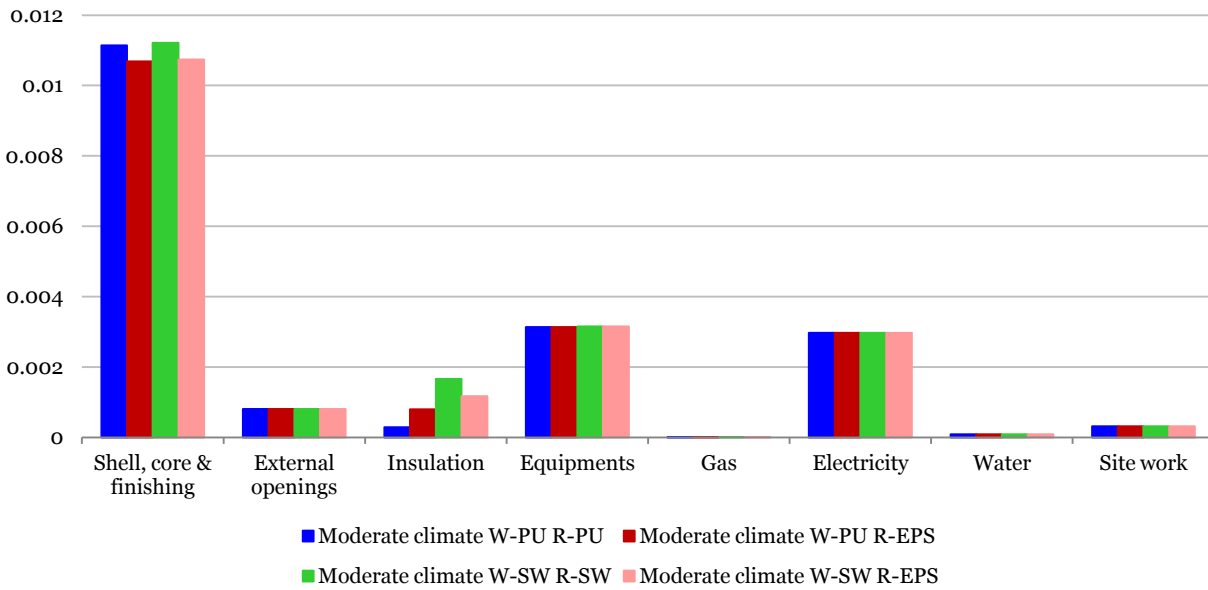

Figure 39 – Breakdown of hazardous waste

Hazardous waste (kg/m²/an)

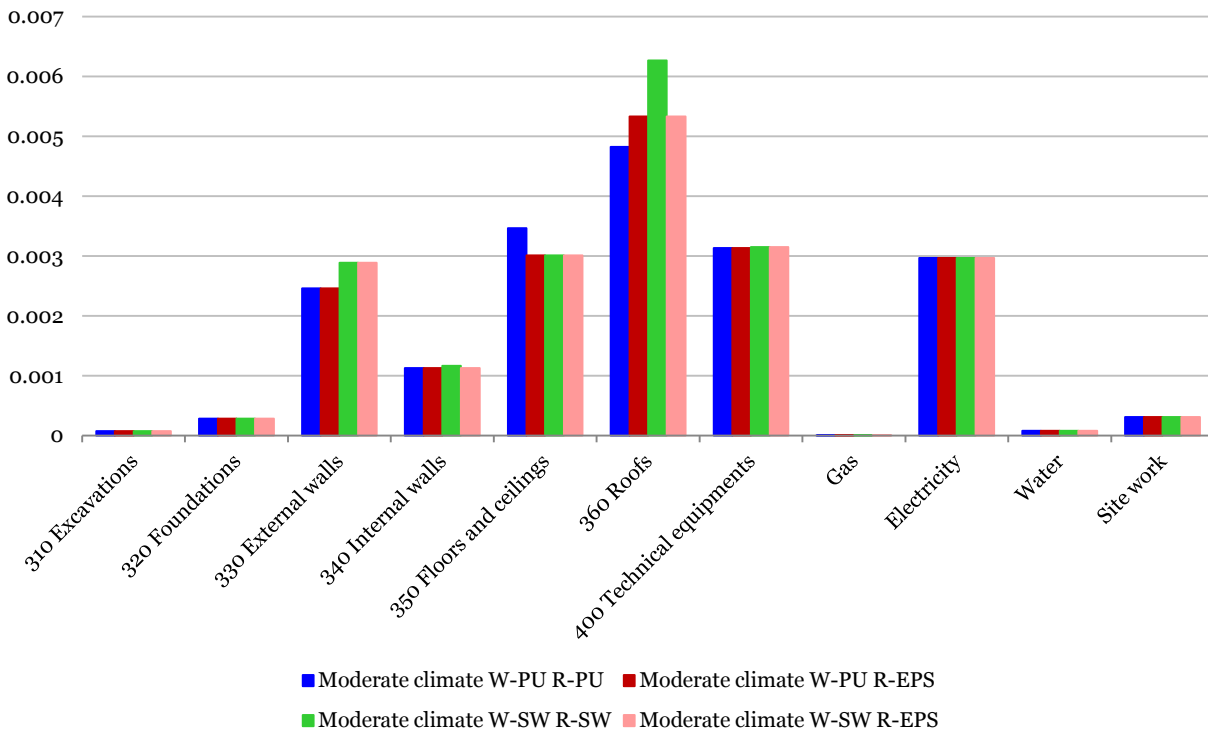

Figure 40 – Breakdown (2) of hazardous waste

The hazardous waste generated by the shell, core & finishing represent more than half the hazardous waste generated on the whole study period. They are notably linked to the external doors and windows. The hazardous waste due to the insulation varies between 1.6% for the W-PU R-PU scenario to 8.4% for the W-SW R-SW scenario.

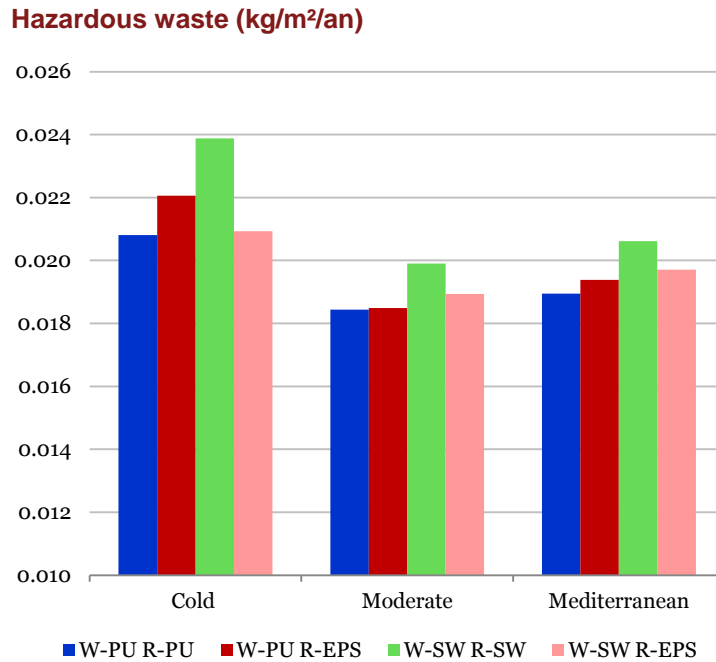

Figure 41 – Hazardous waste on the whole study period for the different climates

The gap between the impact of the scenario W-SW R-EPS and the impacts of the other scenarios in terms of hazardous waste is less significant in the Moderate and the Mediterranean climate compared to the Cold climate.

The explanation is the same than for the previous parts: the gap in terms of quantity of insulation needed in the different alternatives is lower for the Cold climate than for the other climates.

7.1.3.6. Non-Hazardous waste to final disposal

Non hazardous waste (kg/m²/an)

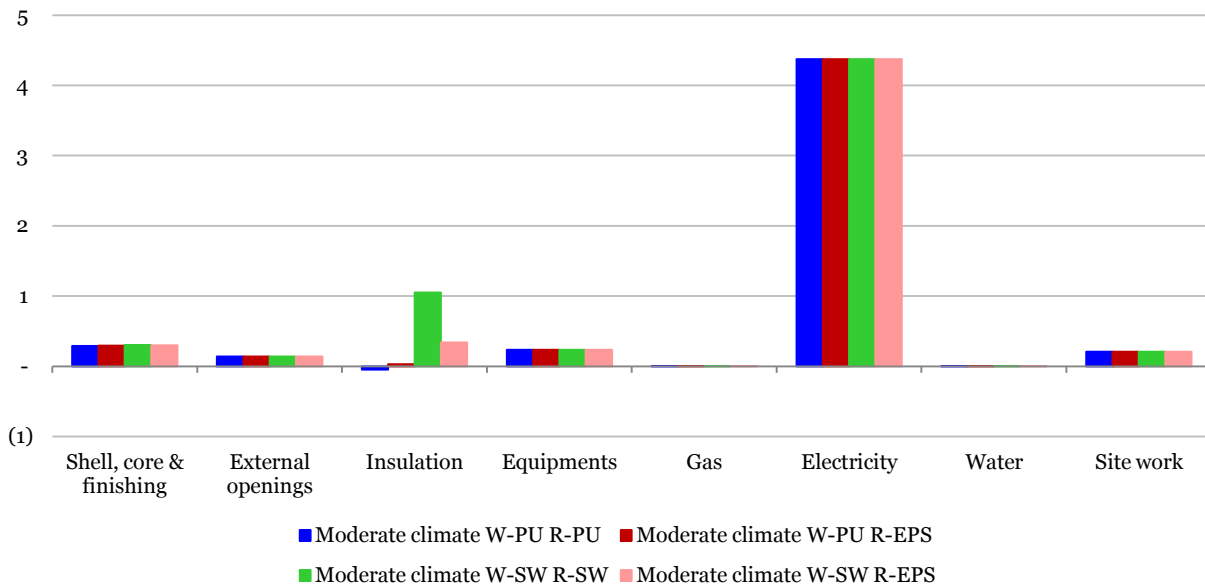

Figure 42 – Breakdown of non hazardous waste

Non hazardous waste (kg/m²/an)

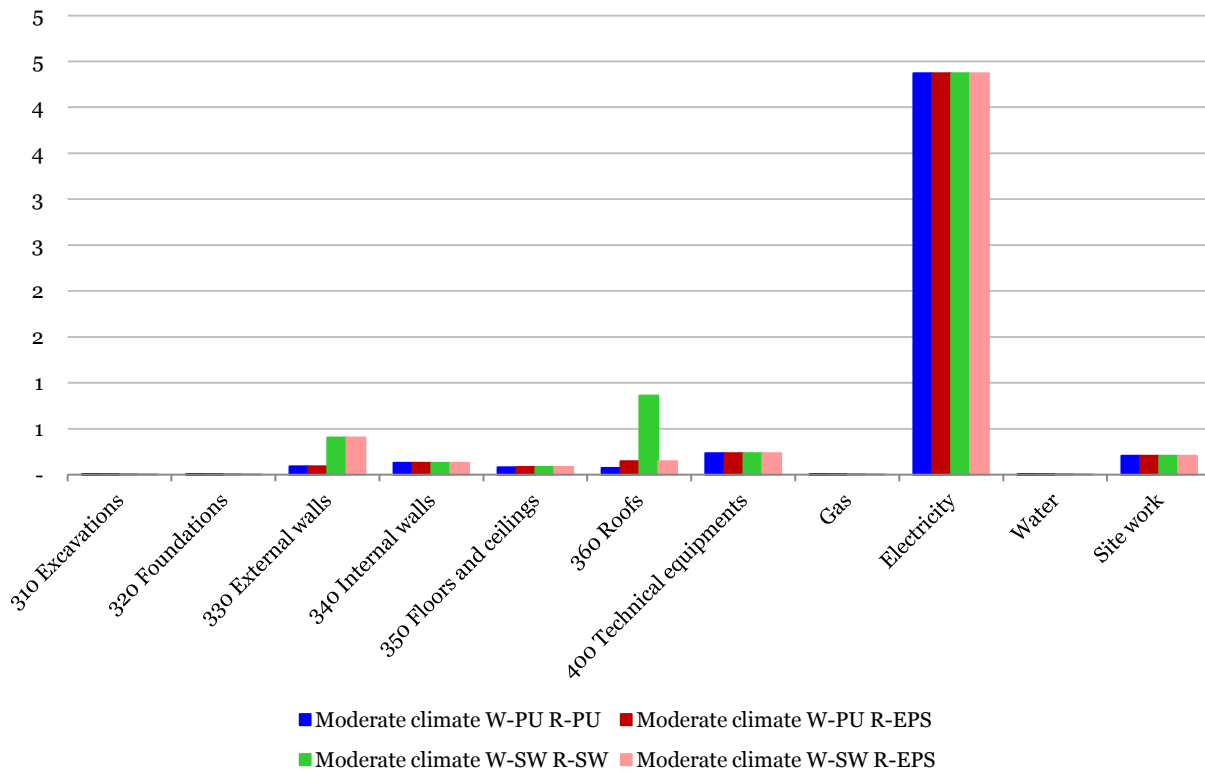

Figure 43 – Breakdown (2) of non hazardous waste

Energy savings linked to the end of life of the PU insulation – incineration of PU foam - is illustrated in the Figure 42 – Breakdown of non hazardous waste.

The non hazardous waste generated by the use of SW insulation represents 60% of the total non hazardous waste generated by the building components for the scenario W-SW R-SW. Indeed, the end of life considered in the SW EPD is quite negative - landfilling without recovery – whereas in the PU and EPS EPDs avoided impacts are taken into account.

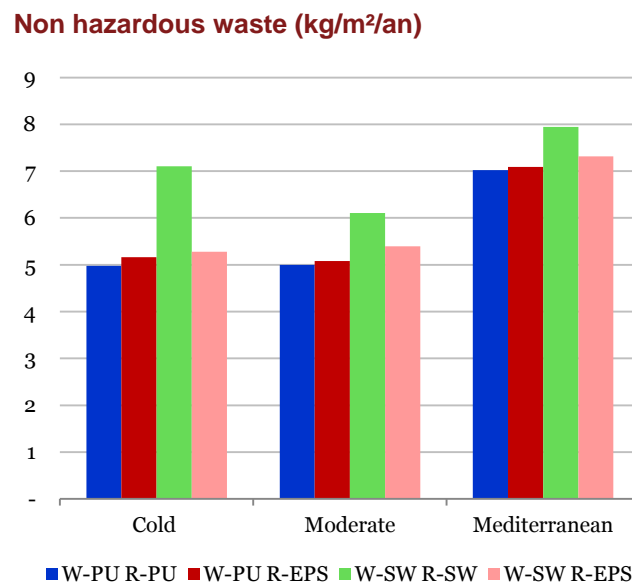

Figure 44 – Non hazardous waste on the whole study period for the different climates

As in the previous section, the gap between the impact of the scenario W-SW R-EPS and the impacts of the other scenarios in terms of non hazardous waste is less significant in the Moderate and the Mediterranean climate compared to the Cold climate.

7.2. Part B

This section presents the results of environmental impacts and cost calculations over the life cycle of a residential house. Results may represent either overall cost and impacts (existing building, renovated parts, use and maintenance, demolition) or relative contributions of the different life cycle stages (building components and materials, energy and water use, refurbishment).

7.2.1. Life cycle costs analysis

7.2.1.1. Overall costs

The summary graph below shows the costs breakdown between the different items for the PU renovation scenario. Construction costs represent the most expensive item with 32%. Energy and maintenance costs are also important. Only 3% of the overall cost is due to refurbishment of the roof.

Life Cycle Cost breakdown [2012 discounted €]

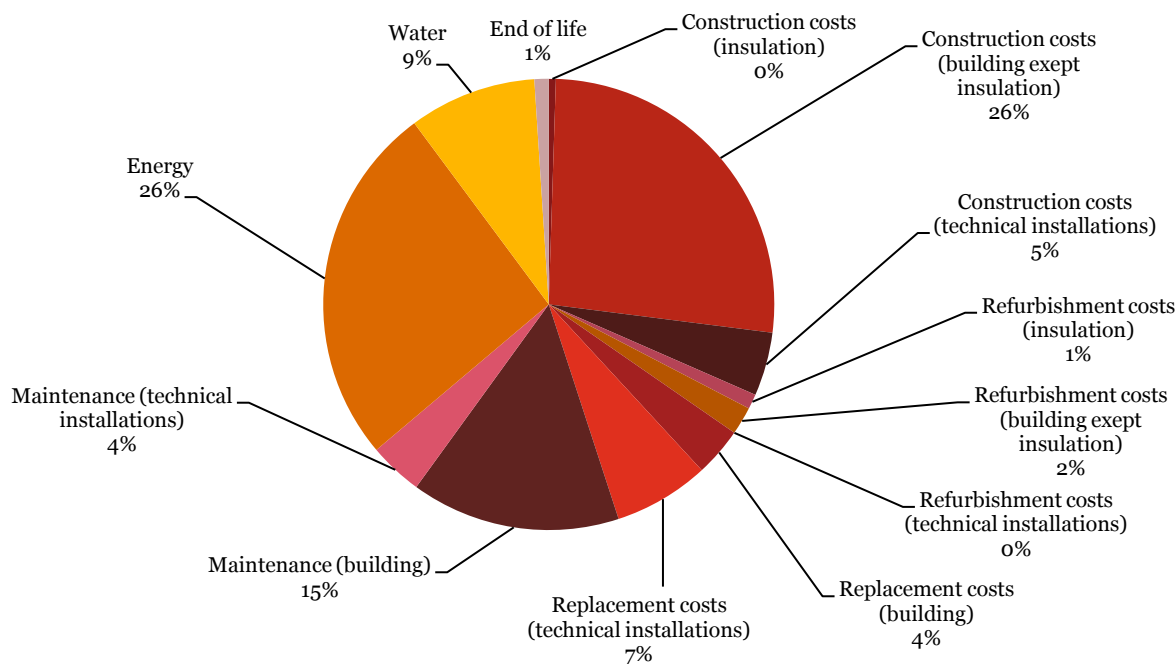

Figure 45 – life cycle cost break down for part B

Total costs for each scenario are roughly equivalent. The differences in total costs are very small (Figure 46 – total costs for part B) and could be explained by the uncertainties on real market prices. The choice of insulation material has thus a limited impact over the cost of the building. The cumulated annual costs reach 398 000 € for PU renovation.

Total costs (2012 discounted €)

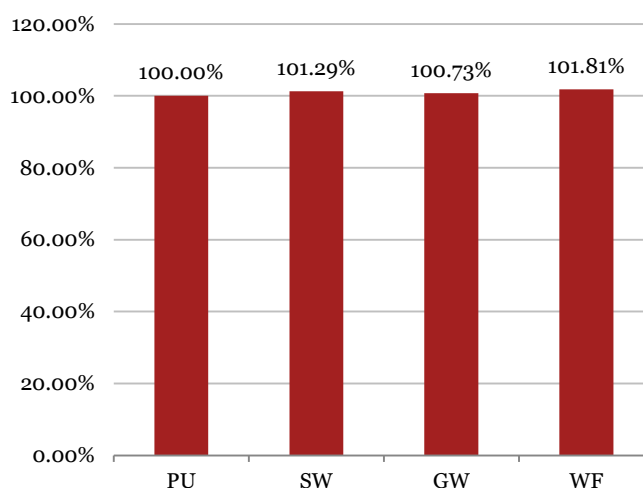

Figure 46 – total costs for part B

When considering only refurbishment costs, the PU renovation scenario is the cheapest. Glass wool scenario is the second cheapest scenario with however 28% extra costs. Wood fibre scenario is 50% more expensive than PU scenario.

Refurbishment costs (2012 discounted €)

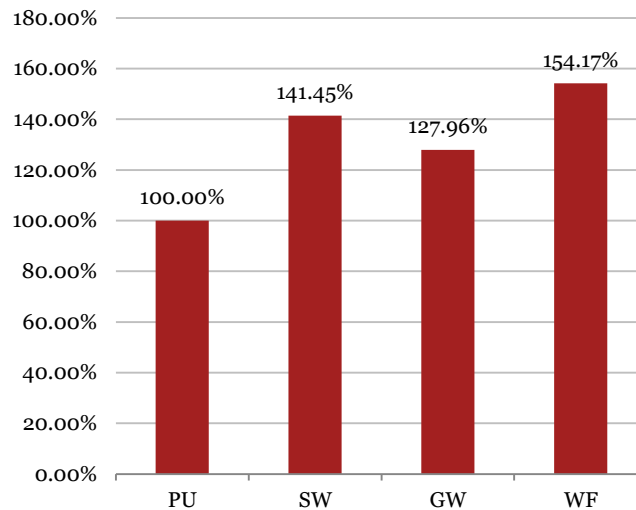

Figure 47 – refurbishment costs for part B

7.2.1.2. Construction costs

The construction costs have been taken from BKI – Kostenplaner software. The refurbishment costs for the different scenarios (including insulation material costs) have been more precisely assessed and are based on commercial prices (for details, see Appendix K. -).

	Construction costs [2012 discounted €]
Initial construction	107547
Initial construction (equipments)	18143
Renovation PU	12206
Renovation SW	17266
Renovation GW	15619
Renovation WF	18818

Table 20 – construction costs part B

The construction costs for refurbishment are also presented hereunder.

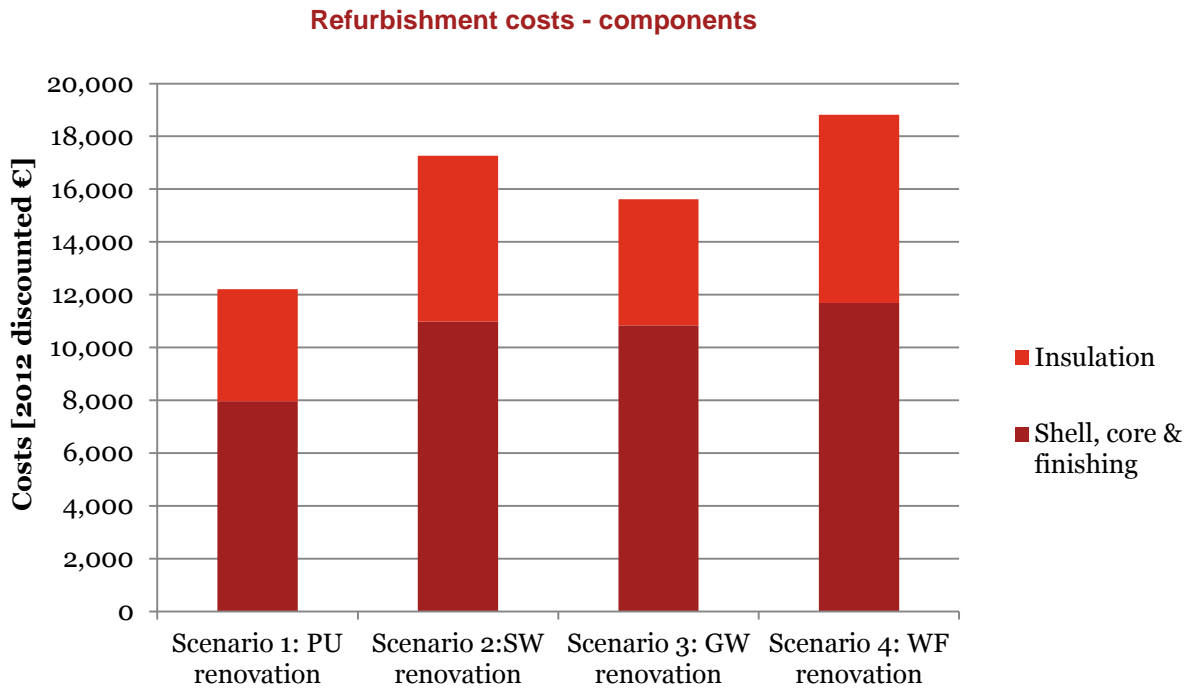

Figure 48 – refurbishment costs - components

7.2.1.3. Regular costs

During the life cycle of the building, regular costs arise from:

- water supply and sewerage;
- energy consumption (gas and electricity);
- maintenance.

7.2.1.3.1. Water

Annual fresh water consumption has been estimated to 35 m³/person, thus 175 m³ in total.

The life cycle cost brings the inflation rate of 2% and the discount rate of 4% into play.

Nominal cost at year n

$$C_{n+1} = C_n * (1+\Delta ea) = C_1 * (1+\Delta ea)^{n-1}$$

Discounted cost year n

$$V_n = C_n / (1+Ta)^n$$

Global life cycle cost:

$$\text{Global cost} = \sum_1^{30} V_n = \sum_1^{30} \frac{C_n}{(1+Ta)^n} = \sum_1^{30} C_0 \frac{(1+\Delta ea)^n}{(1+Ta)^n}$$

With $\Delta ea = 2\%$ and $Ta = 4\%$

Water costs [2012 discounted €]	
2012 costs	744
Life cycle cost	36391

Table 21 – water costs part B

7.2.1.3.2. Energy

Annual energy consumptions have been computed with the thermal model (see section C.2.8). The energy prices have been discussed in the previous section.

In addition to the real price increase, the energy life cycle costs bring the inflation rate of 2% and the discount rate of 4% into play.

Nominal cost at year n

$$C_{n+1} = C_n * (1+\Delta ea) = C_1 * (1+\Delta ea)^{n-1}$$

Discounted cost year n

$$V_n = C_n / (1+Ta)^n$$

Global life cycle cost:

$$\text{Global cost} = \sum_1^{30} V_n = \sum_1^{30} \frac{C_n}{(1+Ta)^n} = \sum_1^{30} C_0 \frac{(1+\Delta ea)^n}{(1+Ta)^n}$$

With $\Delta ea = 2\%$ and $Ta = 4\%$

	2012 [2012 discounted €]	2013 [2012 discounted €]	Life Cycle [2012 discounted €]
Gas	1652	1440	81664
Electricity	393	383	21862

Table 22 – energy costs part B

The figures are the identical from one scenario to another, given that the same functional unit is achieved (same roof U-value).

7.2.1.3.3. Maintenance

During life cycle, the different components of the building are regularly serviced in order to maintain their levels of performance. In this context, we used VDI statistical data to evaluate the costs of the maintenance for each of the building parts.

These costs are divided into repairs and servicing costs.

The total annual costs for maintenance are calculated as follows:

$$E_{\text{annual}} = (\% \text{ repairs} + \% \text{ servicing}) * V$$

The inflation and discount rates are applied in the same way as in previous sections. For calculation details, see Appendix L. -.

	2012	2013	Life Cycle
	[2012 discounted €]	[2012 discounted €]	[2012 discounted €]
PU renovation - building	1183	1217	59718
PU renovation - equipments	313	307	15335
SW renovation - building	1183	1219	59781
SW renovation - equipments	313	307	15335
GW renovation - building	1183	1201	59207
GW renovation - equipments	313	307	15335
WF renovation - building	1183	1236	60322
WF renovation - equipments	313	307	15335

Table 23 – Maintenance costs part B

The maintenance costs do not vary for the equipments. They slightly differ for the building from one scenario to the other, due to the differences in the renovation prices.

7.2.1.4. Replacement costs

All equipments and structure that present a life span lower than the building service life will be replaced one or several times before the building end of life. The incurred costs are based on VDI statistical data. See Appendix M. - for more details.

	Life cycle cost [2012 discounted €]
All scenarios	13961

Table 24 – Replacement costs Part B

	Life cycle cost [2012 discounted €]
All scenarios	27288

Table 25 – replacement costs equipments Part B

	Life cycle cost [2012 discounted €]
All scenarios	0

Table 26 – replacement costs renovation Part B

7.2.1.5. End of life costs

All components of the building will be dismantled at the building end of life. A ratio of 20 €/m³ has been considered to assess end of life costs.

	Life cycle cost [2012 discounted €]
All scenarios	4072

Table 27 – end of life costs Part B

7.2.2. Overall environmental life cycle analysis (LCA), at a glance

7.2.2.1. Overall results on the whole study period

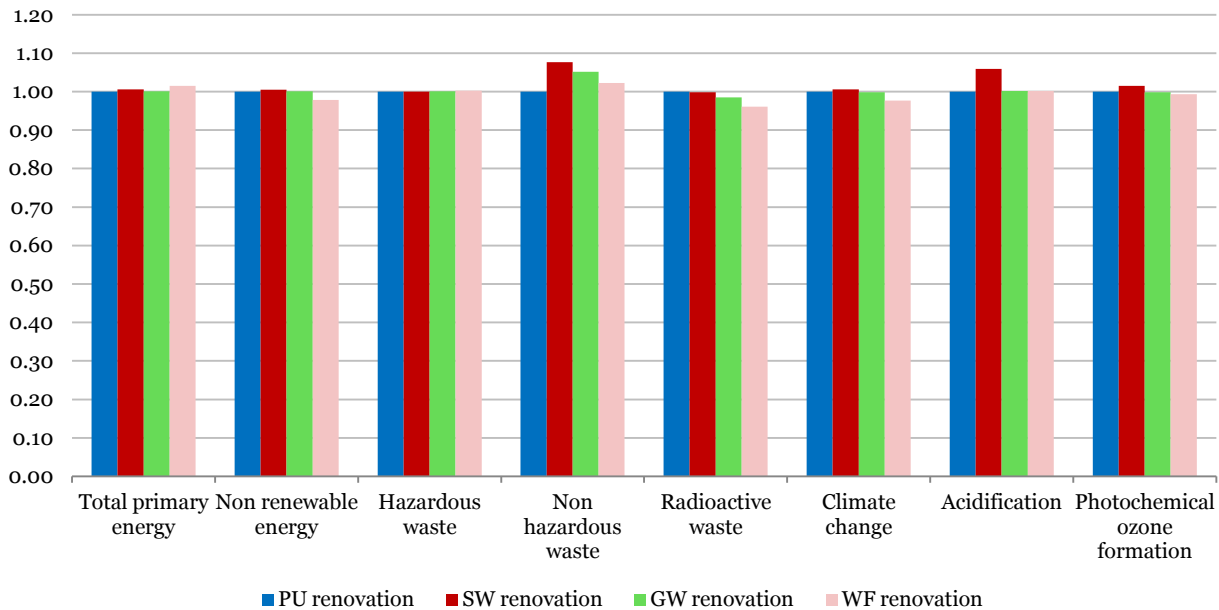

Figure 49 – Relative results on the whole study period (PU scenario being 100%)

Three groups of results can be interpreted from the figure above:

- First of all, no significant variations can be observed between scenarios for the major part of the indicators (Figure 49): total and non-renewable primary energy, hazardous waste, climate change and photochemical ozone formation. Figure 51 shows that at roof components levels variations between scenarios may be identified. Comparable overall results are thus explained by the fact that the rest of the contributors (existing building's components, energy and water uses) accounts as a predominant part of the impacts. The sensitivity analysis also shows that the study period does not account very much in this first observation (see section 8.1).
- For non-hazardous and radioactive waste and acidification slight differences (inferior to 10 %) may be observed but may not be considered with regards to overall uncertainties of the study (see section 8.3).

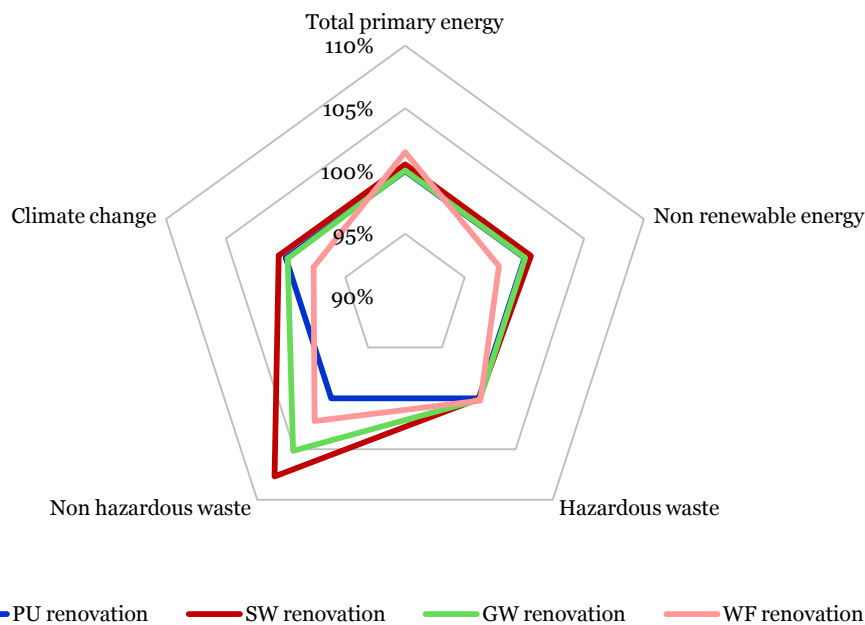

Figure 50 – Relative results on the whole study period (PU scenario being 100%)

Figure 50 reflects previous results for a limited number of indicators that have been selected considering both their particular relevance with regards to issues for construction and their reliability in the present study. PU scenario is also taken as reference.

Overall no clear distinction between the four scenarios can be concluded when considering the whole life cycle of the building.

7.2.2.2. Overall results: components used for roof renovation

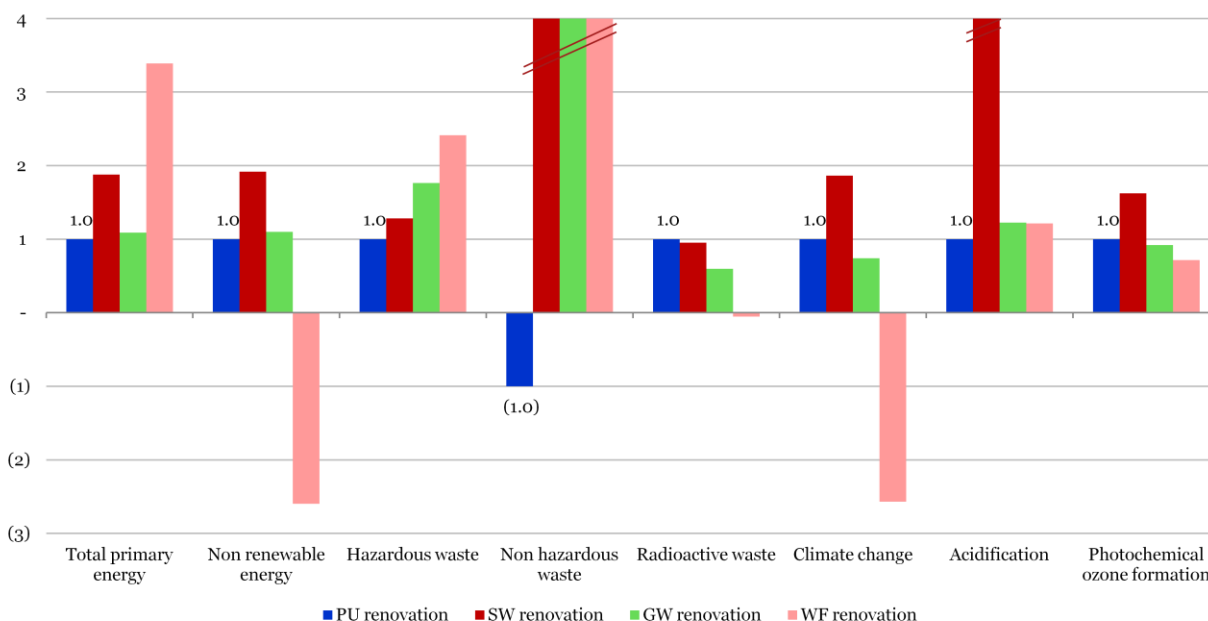

Figure 51 – Relative results for roof renovation components (PU scenario being 100%)

The substitution effect with energy recovery from wood fibre incineration considered at the end of life of the boards shows significant variations from one scenario to another at renovation materials level. Indeed, as modeled in the EPDs, the life cycle scenario comprises on one hand carbon storage with biomass growth as well as renewable energy consumption as feedstock. On the other hand, in the same scenario, non-renewable energy consumption is avoided when fibre boards are incinerated with heat recovery thus compensating.

Thus CO₂ emissions from biomass are neutral: carbon sequestration is balanced by the related CO₂ emissions from the combustion of the feedstock. In addition, CO₂ emissions due to non renewable fuels consumption throughout the manufacturing process and transport are more than compensated by the credits from avoiding non-renewable fuel consumption for CHP production with a higher efficiency. This scenario is contested by many other stakeholders and scientists and currently subject of a debate.

On the contrary, PU scenario presents a net negative amount (close to zero) of non hazardous waste production, this is why the other scenarios are far superior for this impact. The overall negative amount is due to credits for incinerating PU foam at the end of life.

End of life scenarios have significant impacts on the results, and interpretations at this level must consider all assumptions consider for each product as avoided impacts are not always used. For example, GW and SW EPDs are based on the French standard NF P 0-010, which does not allow such credits, although we may assume that end of life benefits for these products must not change the impacts on their whole life cycle.

Results at the level of renovation materials are used to understand and explain where the differences between scenarios come from, but they do not correspond to the objectives of the study that aim at analyzing impacts at building level.

7.2.3. Detailed results per indicator

This series of figures display the results for each indicator. Overall cost and impacts on the 50-year study period are first represented on a time graph, with the following conventions:

- Year 0 represents the construction year of the existing building. All environmental impacts related to the building components and materials (including end of life impacts) are allocated to year 0 on these charts, although they sometimes happen during the whole life span.
- In year 15 the pitched roof is renovated. All environmental impacts related to the new materials installed are also included at this stage. Scenario 0 “no renovation” only considers the renovation of the roof without any new insulation.
- Between years 0 to 15 and 15 to 65, energy and water consumptions related to the use of the house are considered.

A breakdown of the contributions per building component is then presented excluding energy and water consumption at use stage.

The following figures are focused on a selection of indicators, which are considered both for their particular relevance with regards to issues for construction and their reliability in the present study. The full results are available in tables in Appendix B. - “LCA results”.

7.2.3.1. Total cost, over the study period

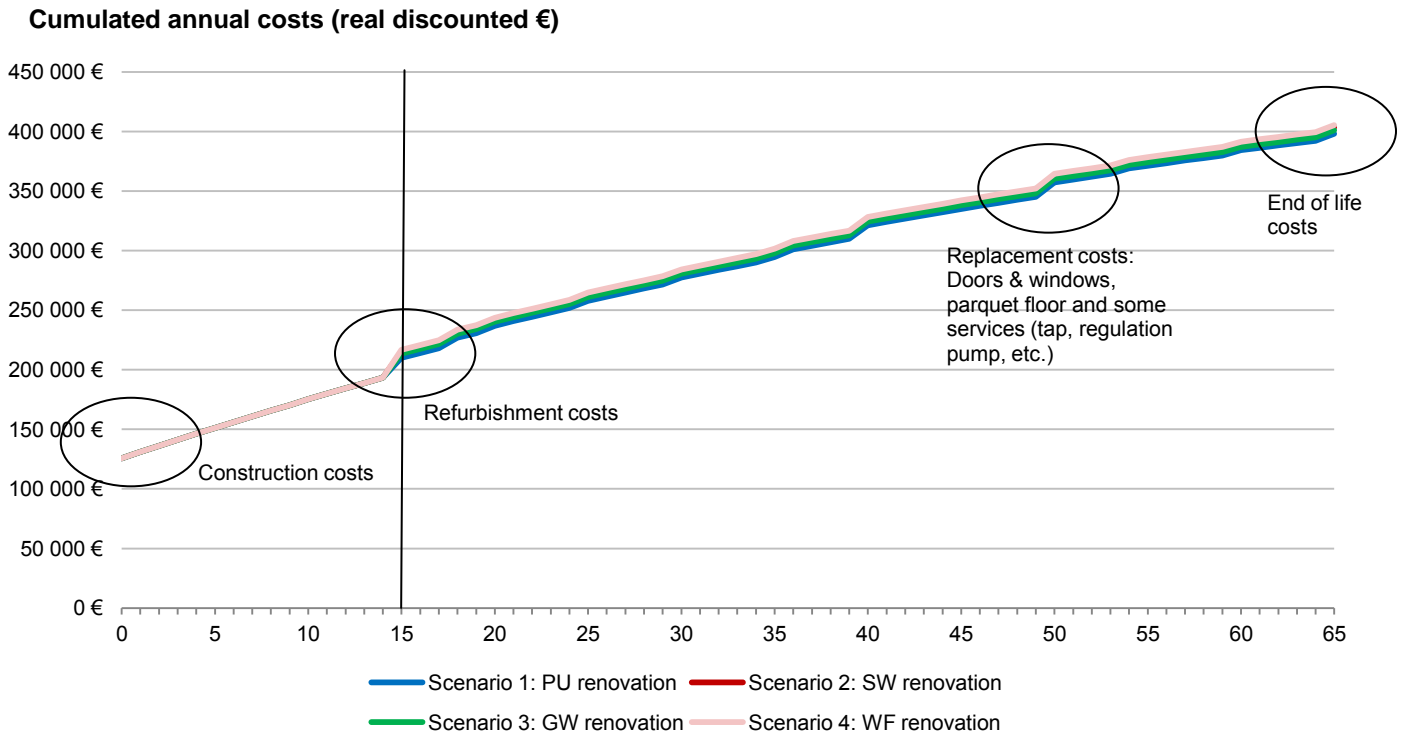

Figure 52 – Total costs, over the study period

Initial construction costs are the same for each scenario. During its use, the building requires various expenditures (energy, maintenance, replacements, etc.) which increase the cumulated annual costs. After 15 years, the refurbishment occurs and differences between the costs of each scenario can be seen on the graph below. The cumulated annual costs increase smoothly except for key years for which replacement costs occur. After 65 years, the building has reached its end of life and is demolished.

Total costs of components (2012 discounted €)

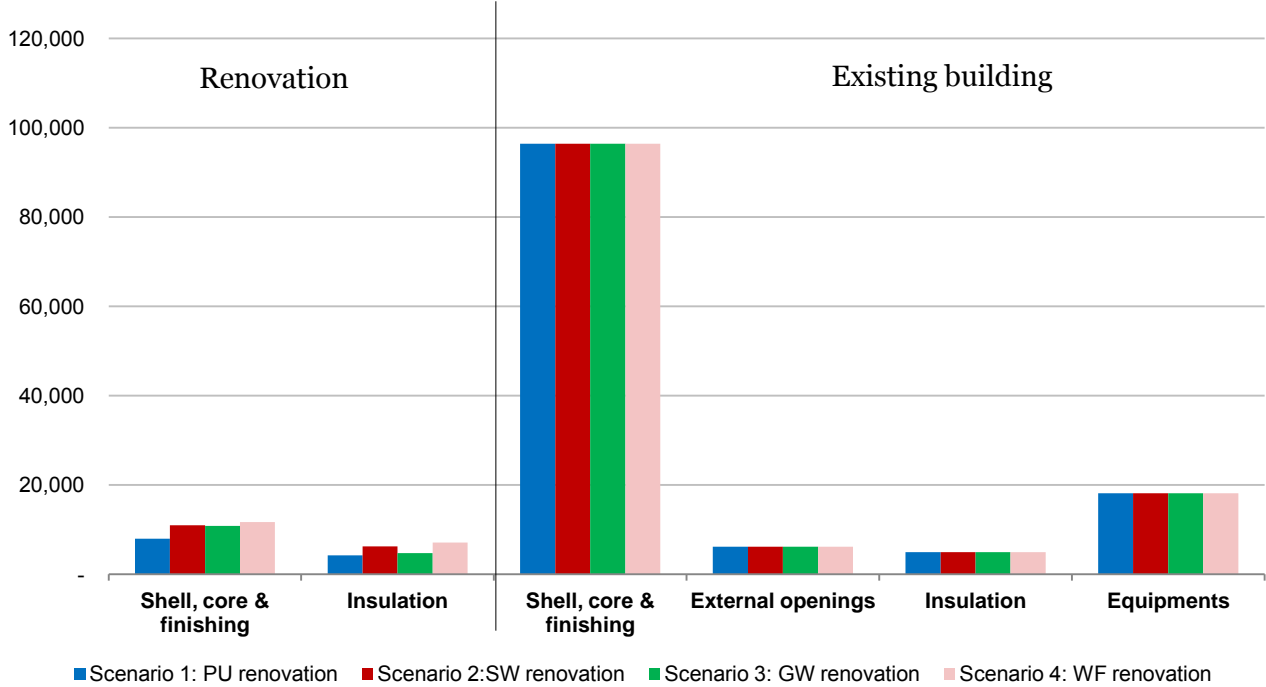

Figure 53 – Total costs of components

Existing building costs are the same for all scenarios. For renovation, the costs of components are smaller for PU scenario whereas WF scenario is the most expensive. Shell, core and finishing components costs (battens, tiles, etc.) are bigger than insulation costs.

7.2.3.2. Input of total primary energy (including feedstock)

Total primary energy (MWh/m²)

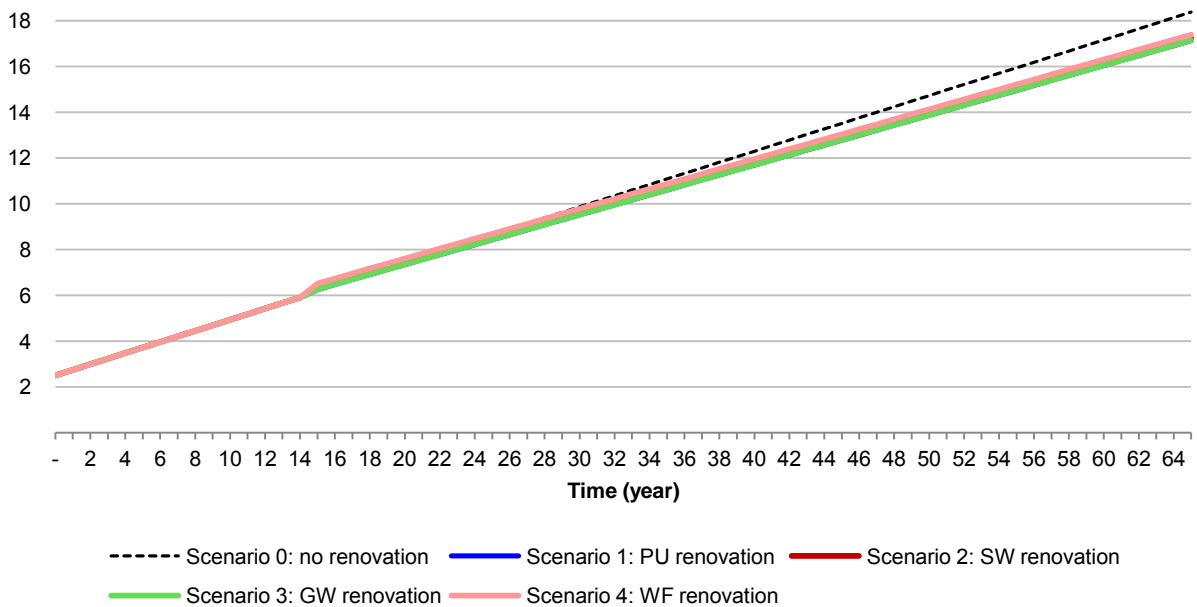

Figure 54 – Total primary energy consumption over time

In an alternative fashion, Figure 54 is built from the same results than those presented in Figure 49 where small differences between scenarios in total are observed. However, on a temporal basis, differences may be observed when comparing to the reference scenario without insulation renovation. A closer look into the ratio between yearly energy usage and primary energy consumed for building components make differences appear in the “Return on Investment”, i.e. the time period after which energy is saved overall (usage + components). It would be around 2 years for GW and PU scenarios, 5 years for SW scenario and 11 years for wood fibre (Figure 55).

Total primary energy (MWh/m²)

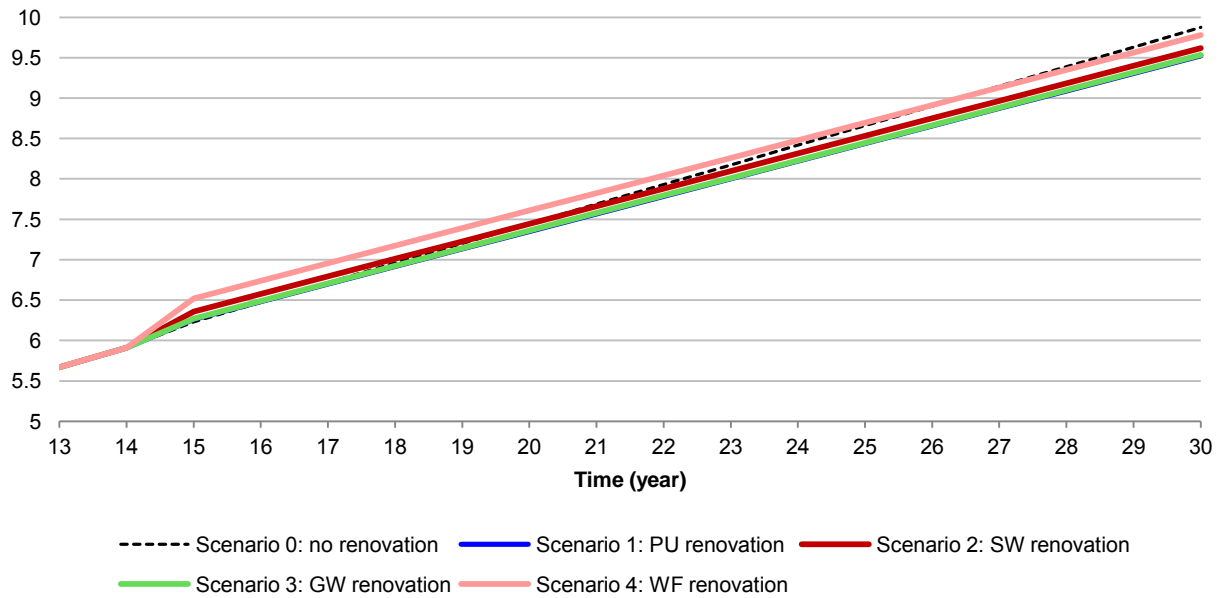

Figure 55 – Total primary energy consumption over time, focus on the RoI of primary energy

Total primary energy (kWh/m²)

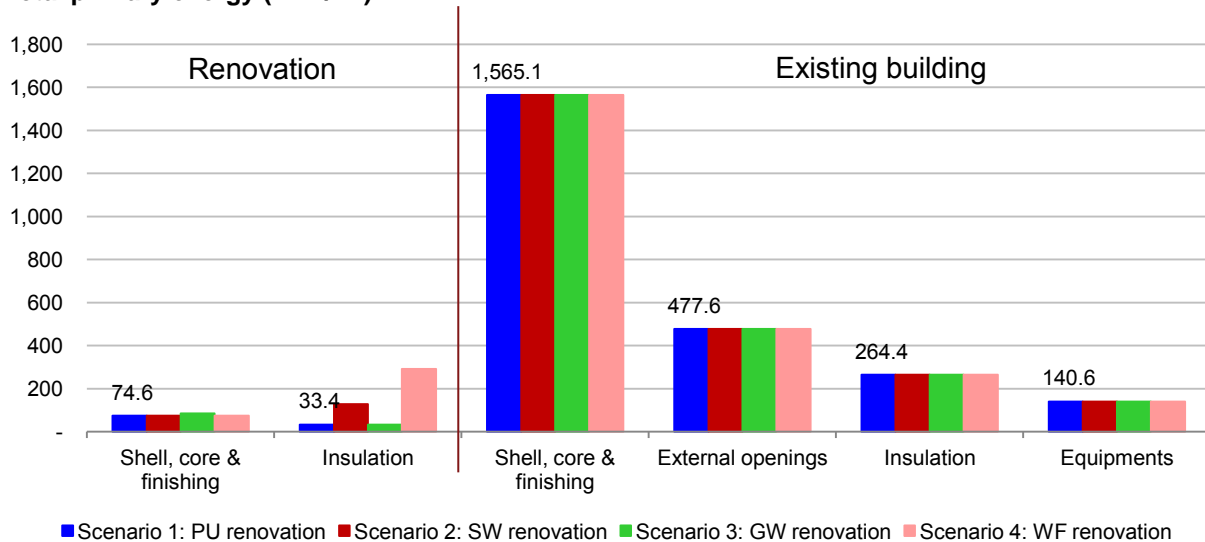

Figure 56 – Total primary energy at building components level

At components level, Figure 56 shows relative impacts of new materials installed for renovation compared to those from the existing building. Primary energy consumption due to new insulation installed is more or less comparable to the one related to the replacement of tiles, rafters and plaster boards (for GW scenario). Renovation represents an increase of 4 to 15% of total primary energy consumption compared to the existing building.

7.2.3.3. Input of non-renewable primary energy (including feedstock)

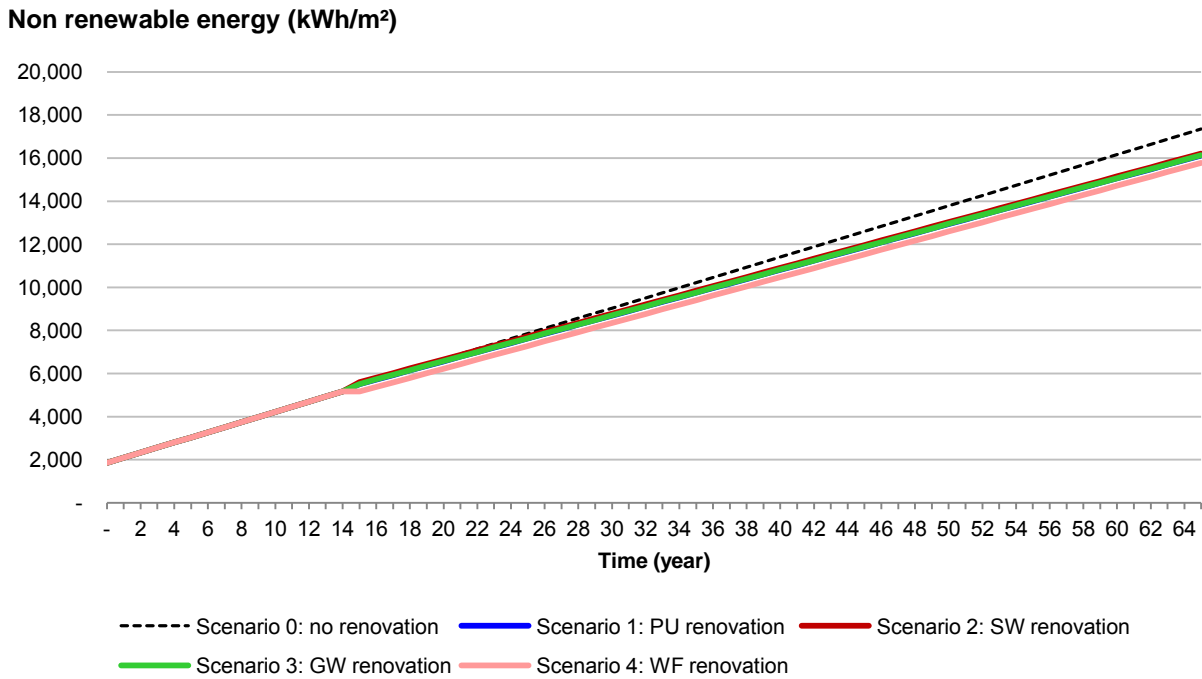

Figure 57 – Non renewable primary energy consumption over time

Impacts on non-renewable primary energy consumption are rather similar to total primary energy except for WF scenario, as a large part of non-renewable energy is compensated at end of life, whereas the large part of primary energy consumption is from renewable.

Non renewable energy (MWh/m²)

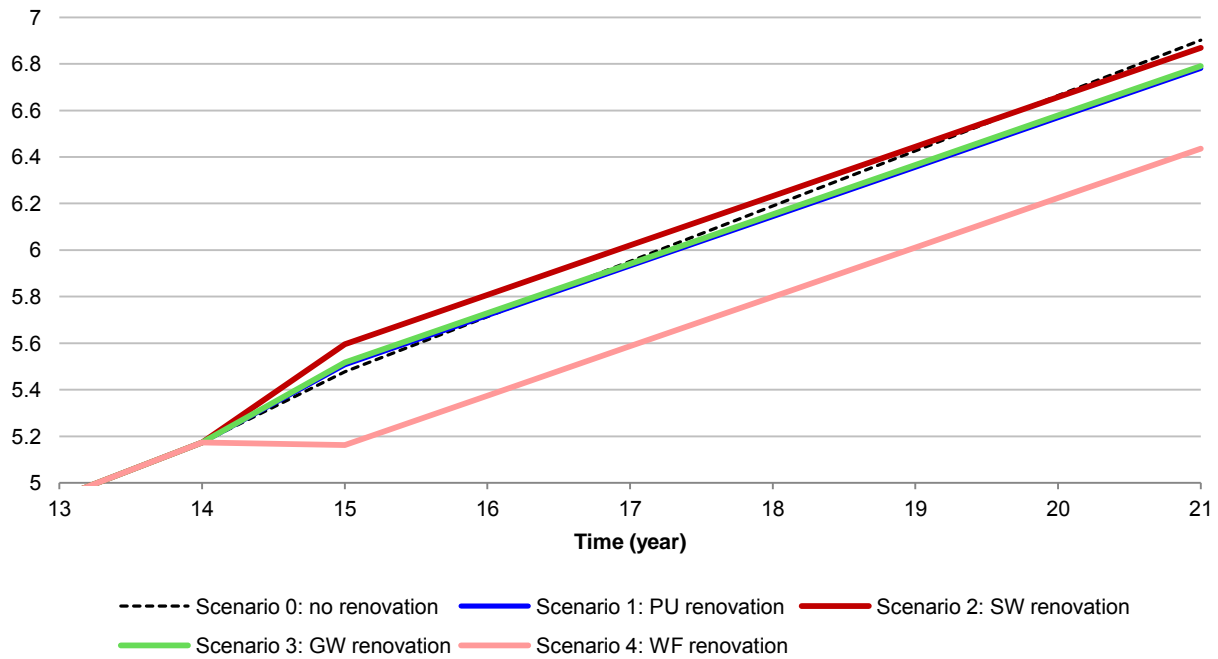

Figure 58 – Non renewable primary energy consumption over time, focus on the RoI of primary energy

Avoided impacts of wood fibre incineration bring a direct benefit to overall non renewable energy consumption. Then, GW and PU scenarios present the shortest time period of about 1.5 year over which non renewable energy consumed for the roof renovation is compensated by energy savings due to thermal performance improvement. About 5 years are necessary for the SW scenario to balance non renewable energy consumed for the installation of new components.

Non renewable energy (MWh/m²)

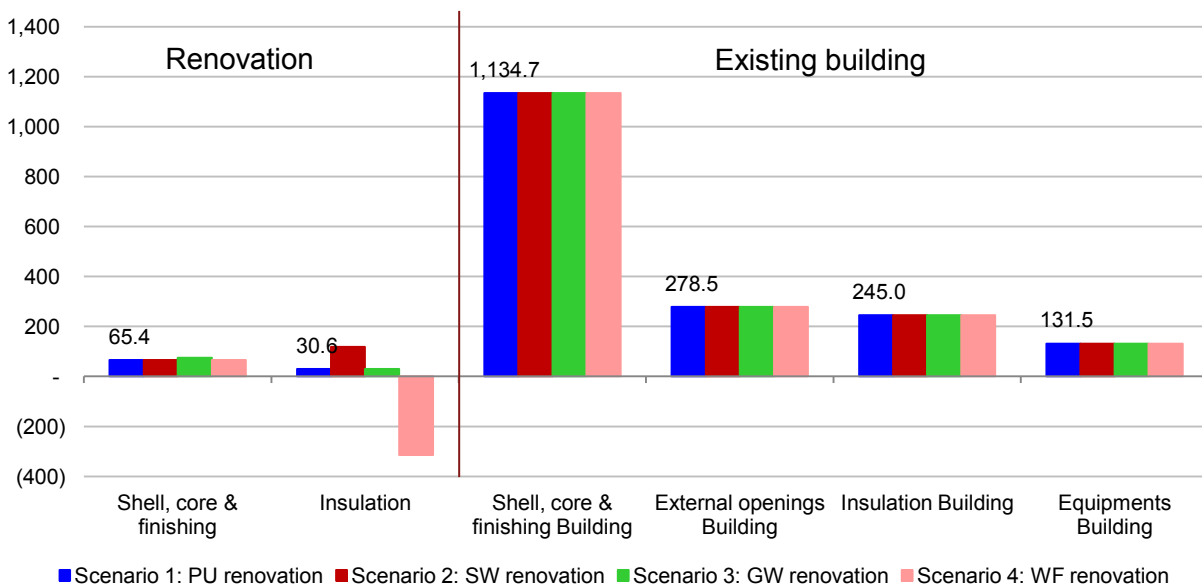

Figure 59 – Non renewable primary energy at building components level

Renovation represents impacts from -14 % to 15 % of the one due to the existing building.

7.2.3.4. Climate change

Climate change (kg CO₂ eq/m²)

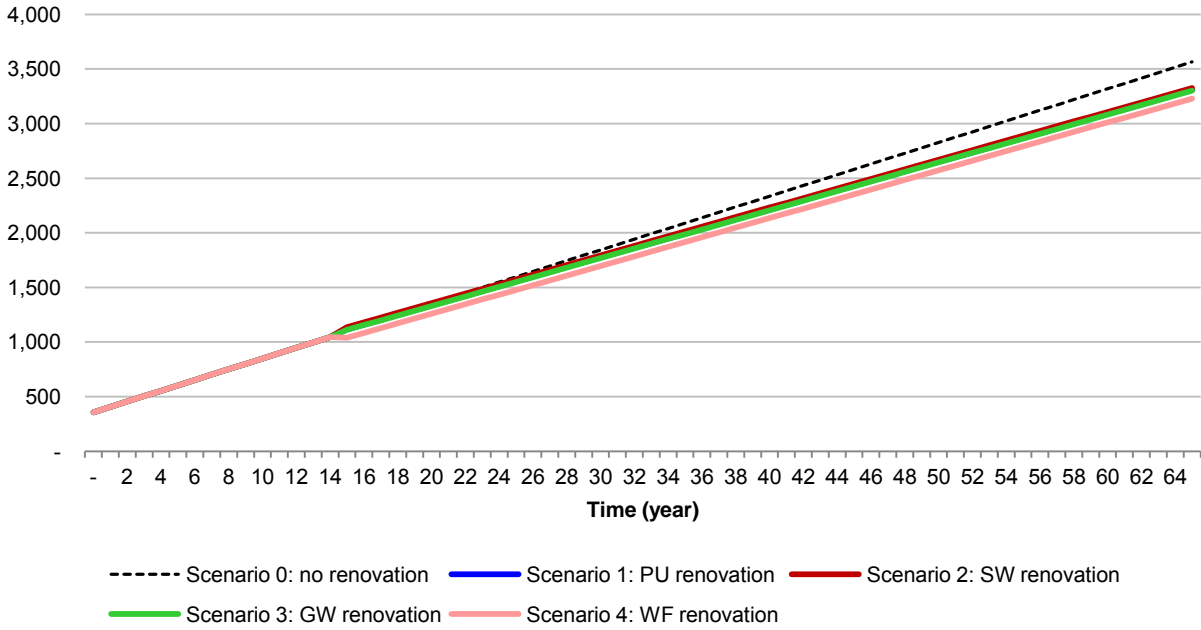

Figure 60 – Climate change over time

Impacts on climate change directly reflects non-renewable primary energy consumption (fossil fuels), as there are few process emissions related to the building components manufacturing (e.g. process of cement manufacturing releases CO₂ emissions from the chemical transformation of the limestone (CaCO₃) to lime (CaO)), which are located in the existing part.

Climate change (kg CO2 eq/m²)

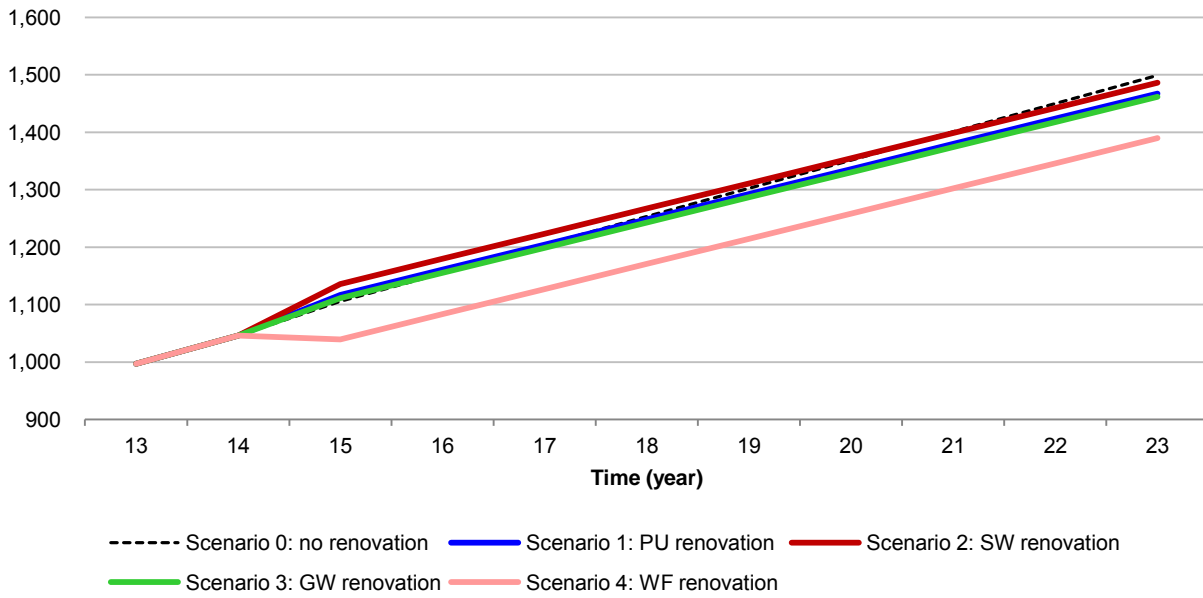

Figure 61 – Climate change over time, focus on the RoI

Then, GW and PU scenarios present the shortest time period of about 2 years over which GHG emissions due to the roof renovation is compensated by the one related to energy savings. About 5 years are necessary for the SW scenario to balance impacts on climate change of the installation of new components.

Avoided impacts of wood fibre incineration bring a direct benefit to overall greenhouse gas (GHG) emissions. This result must be carefully considered, as the compliancy of the methodology used being criticized (see section 6.4.1.1.2).

Climate Change (kg eq. CO2/m²)

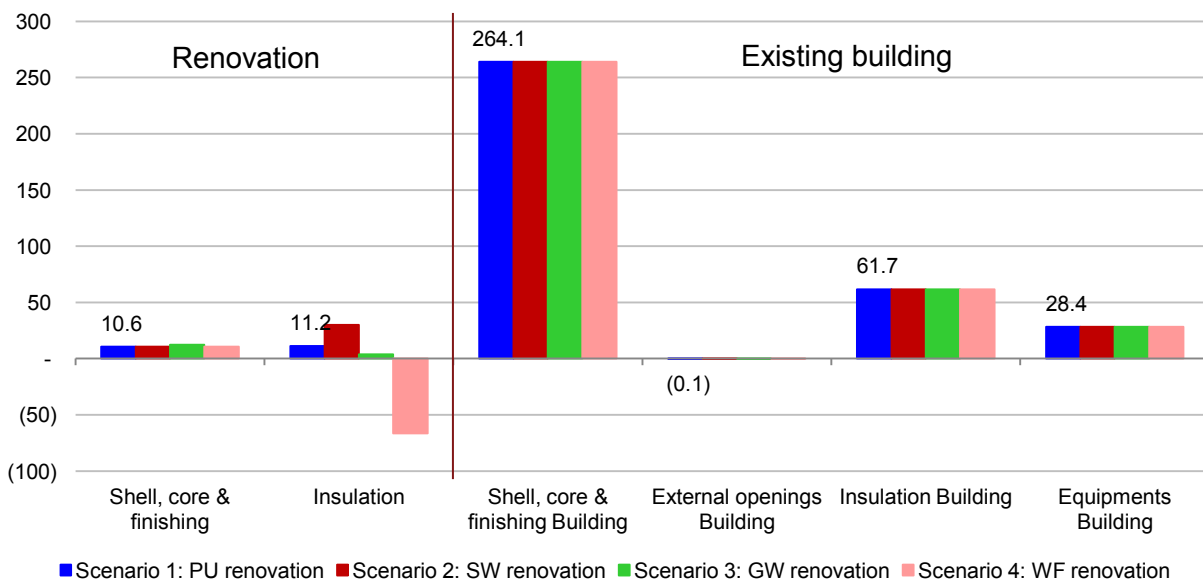

Figure 62 – Climate change at building components level

Impacts on climate change of the materials installed for the roof renovation represent between -15 % to 11% of the existing building's impacts. External openings are made from timber and thus are carbon neutral.

7.2.3.5. Acidification

Acidification (kg SO₂ eq/m²)

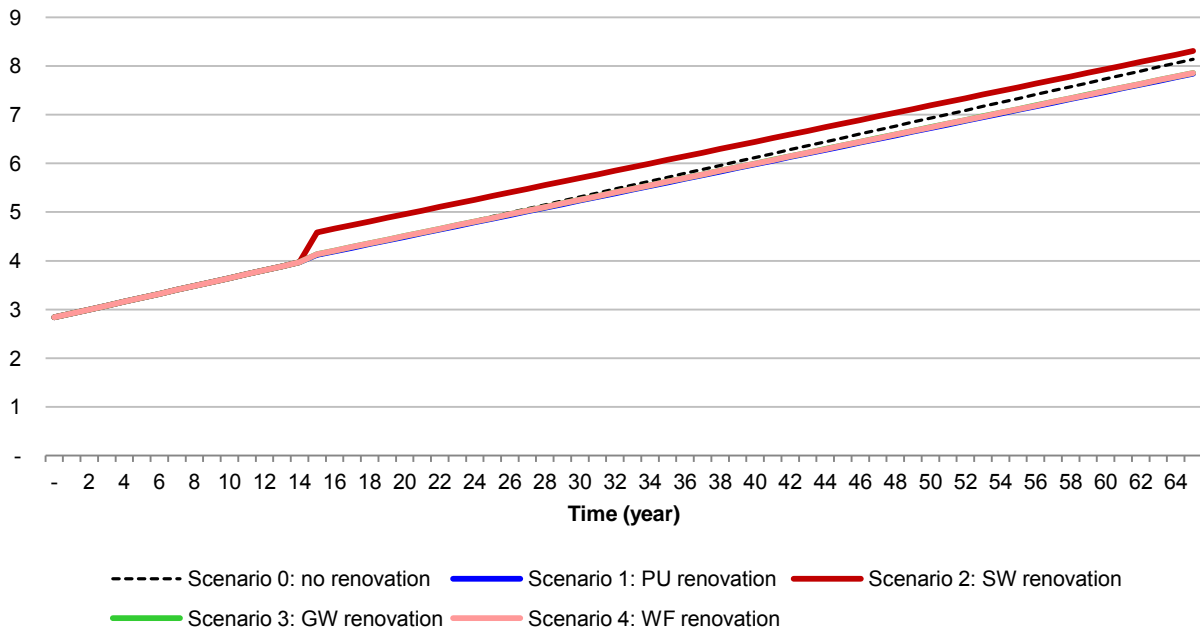

Figure 63 – Acidification over time

Acidification of the natural environment (air, water and soils) is mainly due to sulfur and nitrous oxides emitted from combustions processes. Although there is no real gain in acidification impacts from the renovation, we may notice that SW scenario specifically presents a certain amount of acid emissions that never seems to be recovered over the study period.

Acidification (kg SO₂ eq/m²)

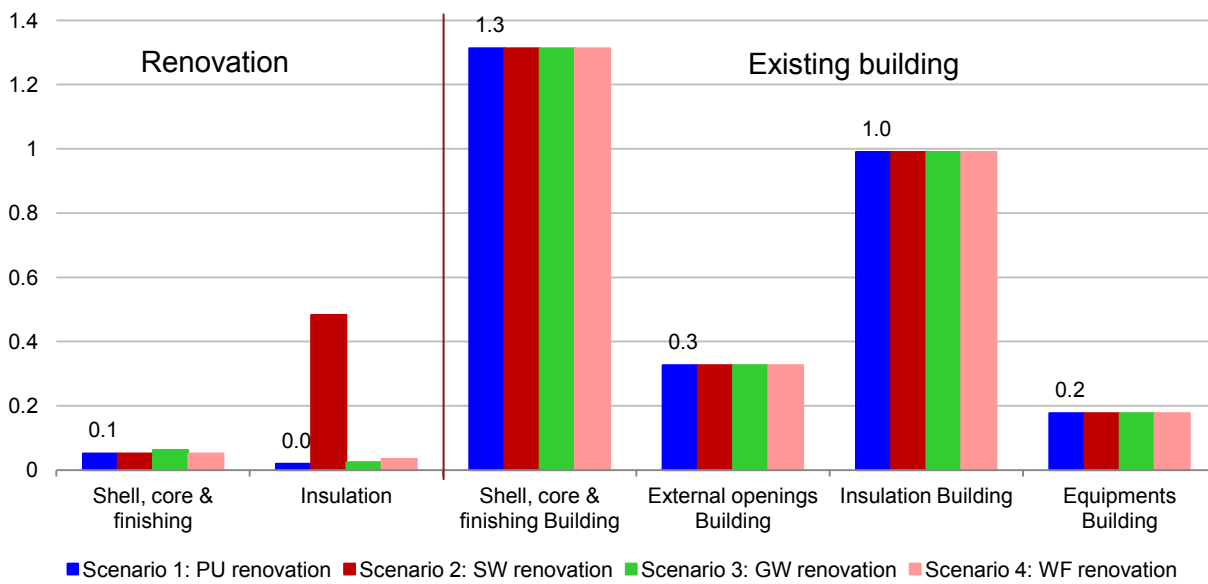

Figure 64 – Acidification at component level

Higher impacts of SW on acidification are illustrated in Figure 64. They represent the half of acidification impacts of the insulation of the existing building, which is stone wool insulation on external walls (10 cm) and in the roof (60 cm), the latter being replaced by 235 cm of new SW insulation. As a result, materials installed for the roof renovation represents 19% of the acidification impacts of the existing building, whereas they represent around 3% of the existing building for the other scenarios.

7.2.3.6. Hazardous waste to final disposal

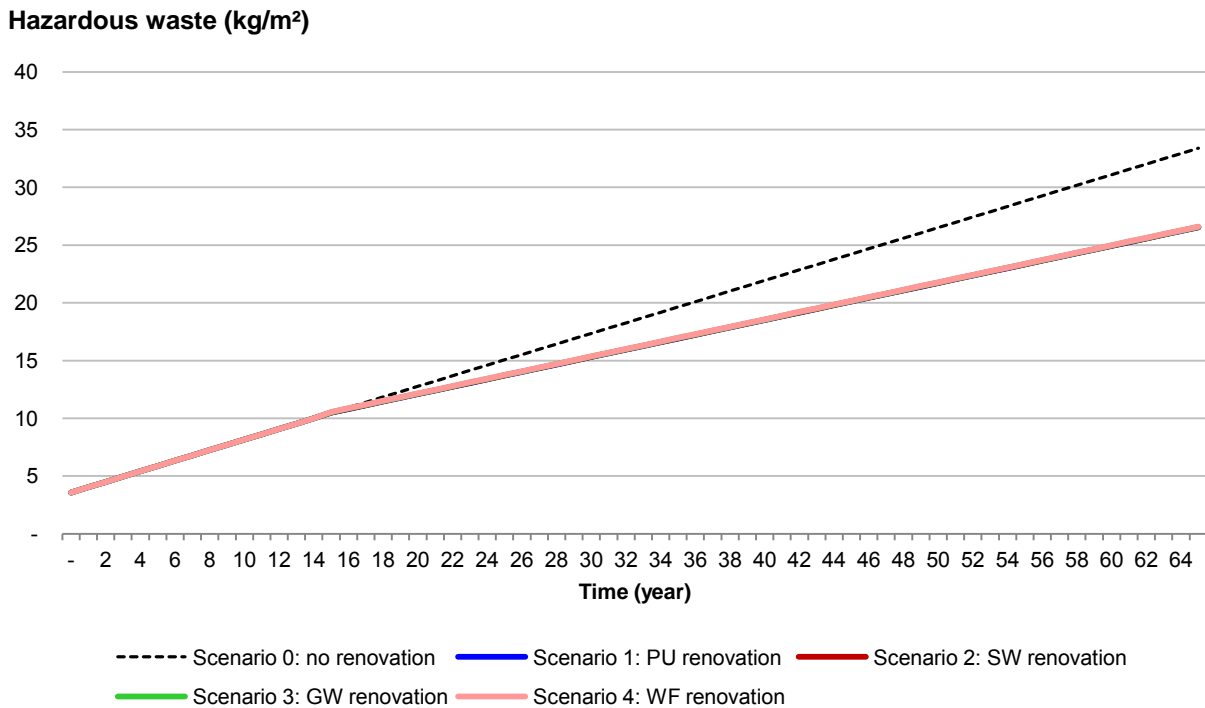

Figure 65 – Hazardous waste generation over time

Hazardous waste generation over time does not accurately represent impacts of waste as they mainly occur at the end of life of the building or components, which are virtually allocated to the construction year instead of the demolition or replacement year. This is due to the availability of current LCI data in aggregated formats from EPDs. Yet, the installation of new insulation brings immediate savings on hazardous waste from energy production, which generates more hazardous waste than building materials, with regards to the building's functional unit.

Hazardous waste (kg/m²)

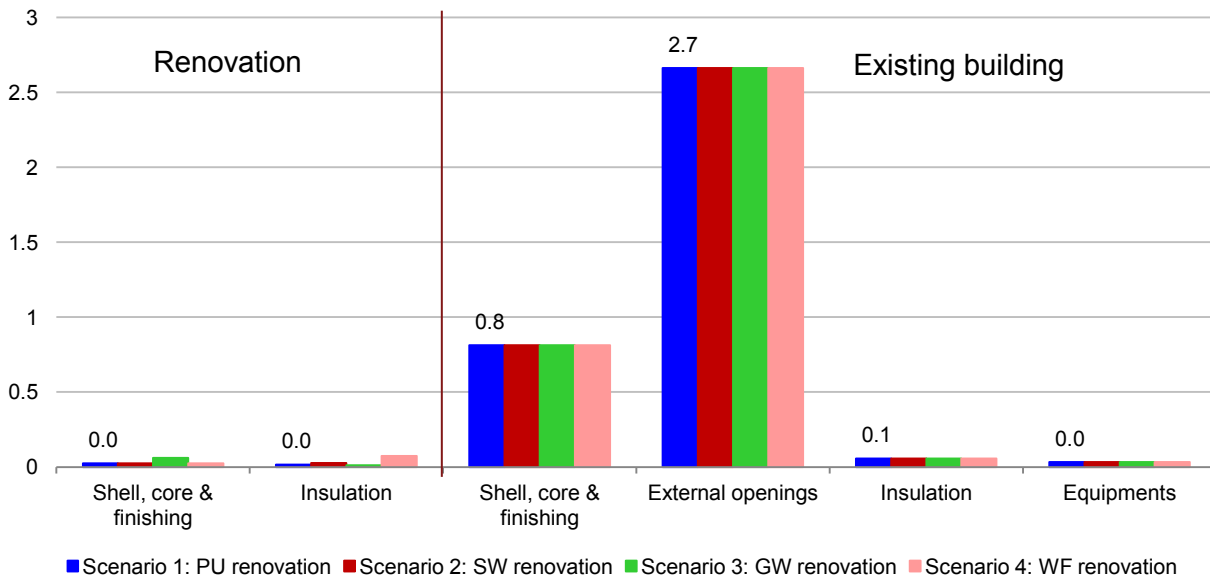

Figure 66 – Hazardous waste generation at component level

Hazardous waste is mainly driven by the external doors and windows, as shown in Figure 66. Impacts of the roof renovation are then negligible.

7.2.3.7. Non-Hazardous waste to final disposal

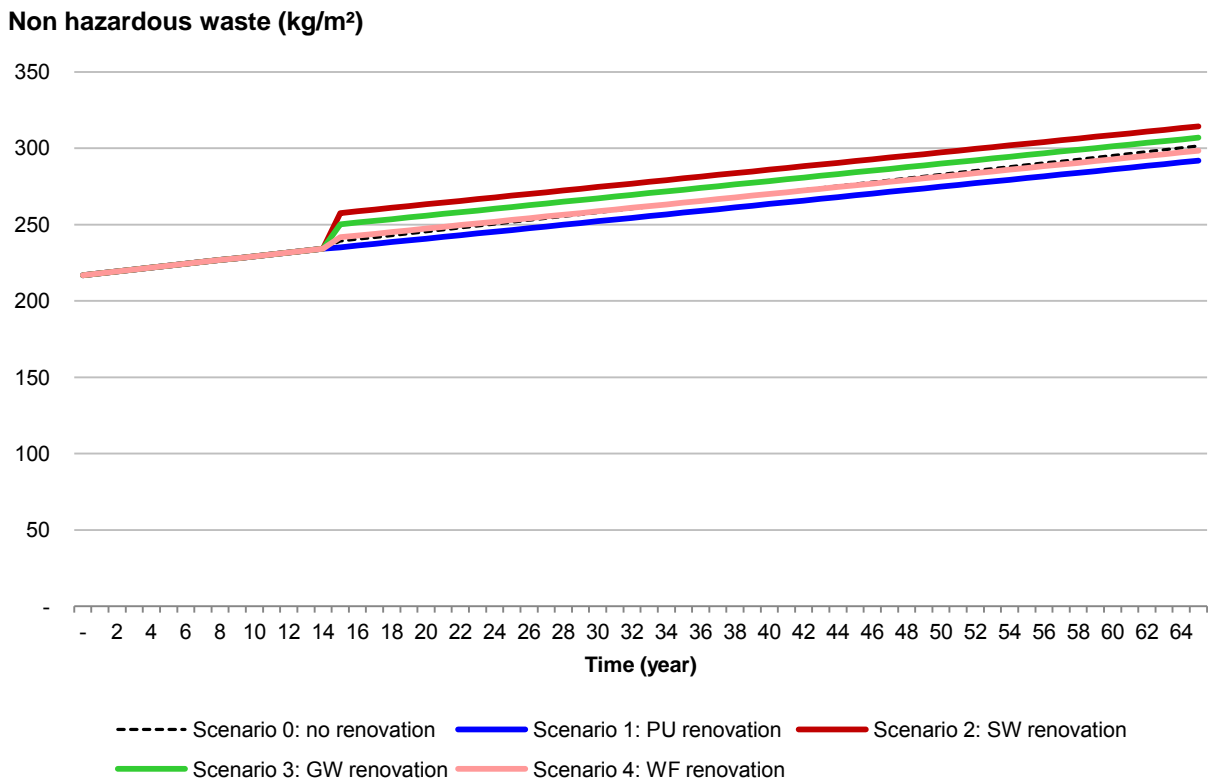

Figure 67 – Non hazardous waste generation over time

Benefits from energy savings after refurbishment do not reduce non hazardous waste generation very much compared to hazardous waste reduction. As there is not any significant gain through the renovation in non-hazardous waste generation, impacts due to the installations for the renovation are never recovered for GW and SW scenarios, whereas for PU and WF scenarios energy savings immediately balance or compensate 12 years later waste generated from the renovation operation.

On Figure 67 we can also see that building components are the main sources of non hazardous waste generation over the life cycle (about $\frac{3}{4}$ of total non hazardous waste generation).

Non hazardous waste (kg/m²)

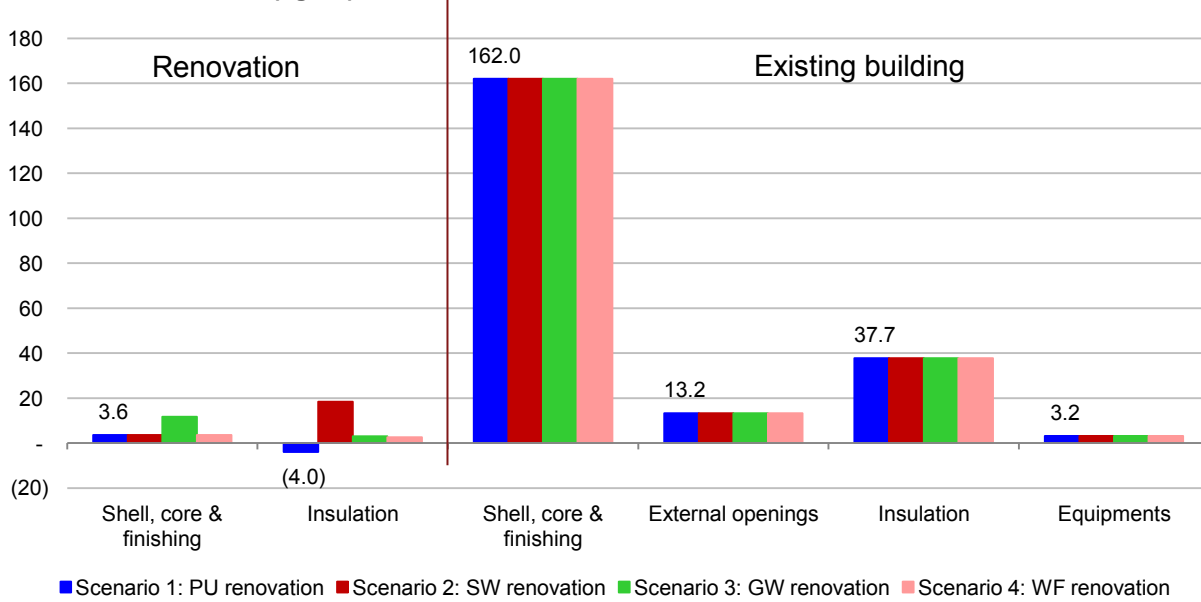

Figure 68 – Non hazardous waste at component level

Finishing represent about two thirds of non hazardous waste generation for the existing building, whereas loadbearing walls only generate 0.5 %. Thus, insulation products installed for renovation have impacts as high as about 10% of the one related to the insulation of the existing building.

8. Limitations and Sensitivity analysis

8.1. Sensitivity analysis for different study periods

The choice of the study period may influence the results as threshold effect might happen due to the fact that building components do not have the same lifespan and may be replaced once more when the study period is extended.

The impact values for each study period have been considered over the whole life cycle, including the energy and water consumptions at use stage.

8.1.1. Part A

In order to assess the influence of the study period on the variations of impacts between the four scenarios, we compared the overall results for a 30 year, a 50 year and a 60 year study period.

The sensitivity to the variation of the study period for each scenario is compared on a normalized basis, the impact value of the Moderate W-PU R-PU scenario for a 50 year lifespan being 100%.

Total primary energy

Total primary energy: variations for 30 years and 60 years

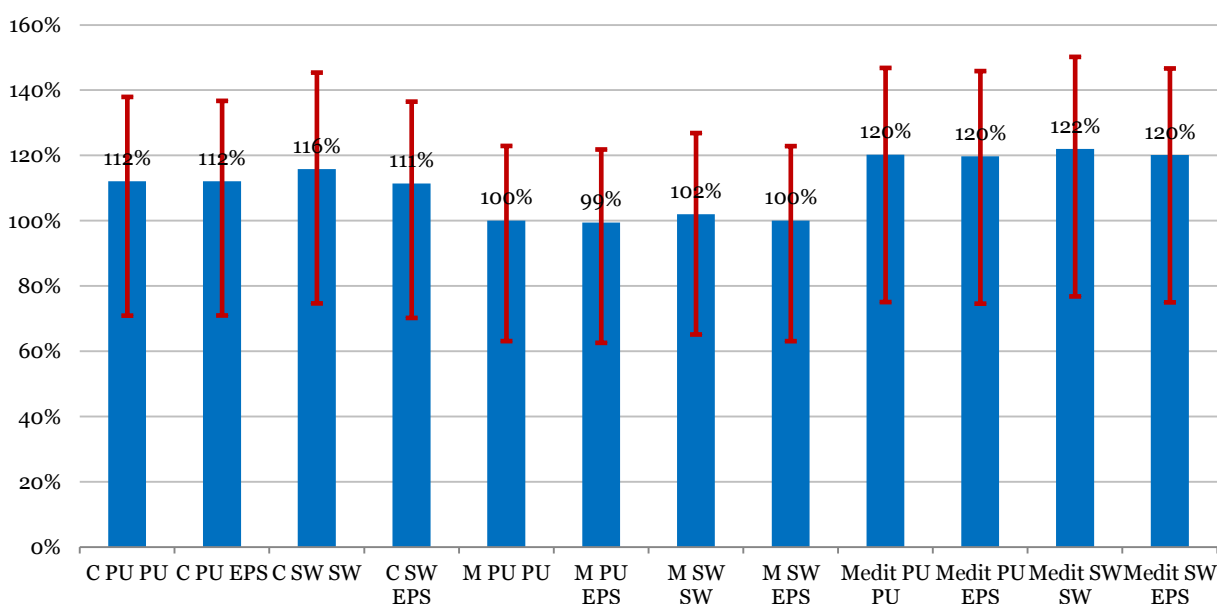

Figure 69 – Sensitivity analysis of the lifespan on total primary energy

Regarding Total primary energy, the maximum gap between the impact values of the different scenarios in one climate is equal to:

- 6% of the overall results for a 30 year lifespan;
- 4% of the overall results for a 50 year lifespan;

- 7% of the overall results for a 60 year lifespan.

For each different lifespan, the ordering remains practically the same between the impact values of the different scenarios.

The change in ordering for the different climate that has been identified in section 7.1.3.1 (Input of total primary energy (including feedstock)) for a 50 year lifespan is not as significant for a 60 year lifespan.

Climate change

Climate change: variations for 30 years and 60 years

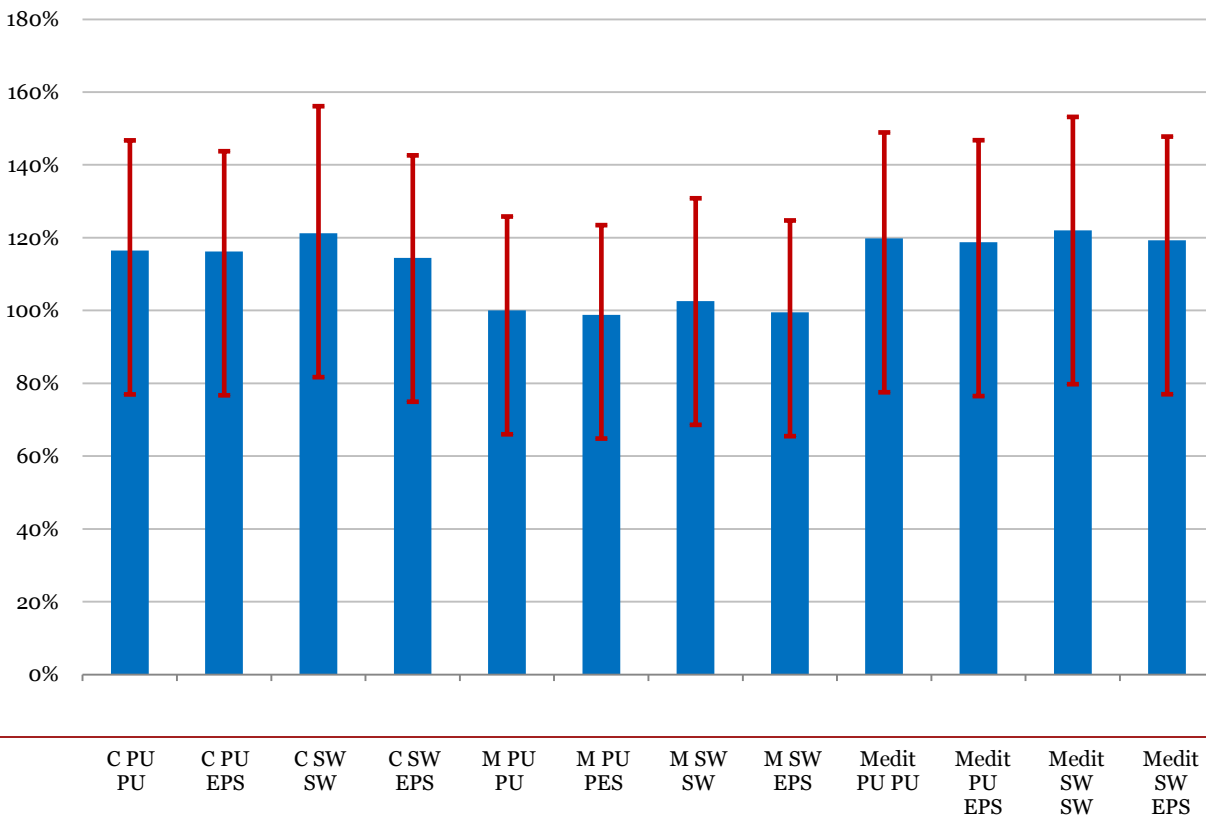

Figure 70 – Sensitivity analysis of the lifespan on climate change

Regarding Climate Change, the maximum gap between the impact values of the different scenarios in one climate is equal to:

- 9% of the overall results for a 30 year lifespan;
- 6% of the overall results for a 50 year lifespan;
- 9% of the overall results for a 60 year lifespan.

For each different lifespan, the ordering remains the same between the impact values of the different scenarios for each climate.

8.1.2. Part B

In order to assess the influence of the study period on the variations of impacts between the four scenarios, we compared the overall results for a 45 year, a 65 year and a 75 year study period. The same scenarios are considered; renovation's lifespan is the only parameter that changes from 50 years to 30 or 60 years.

The sensitivity to the variation of the study period for each insulation material is compared on a normalized basis, the impact value of the PU insulation for a 50 year lifespan being 100%.

Total primary energy

Total primary energy: variations for 60 and 30 years

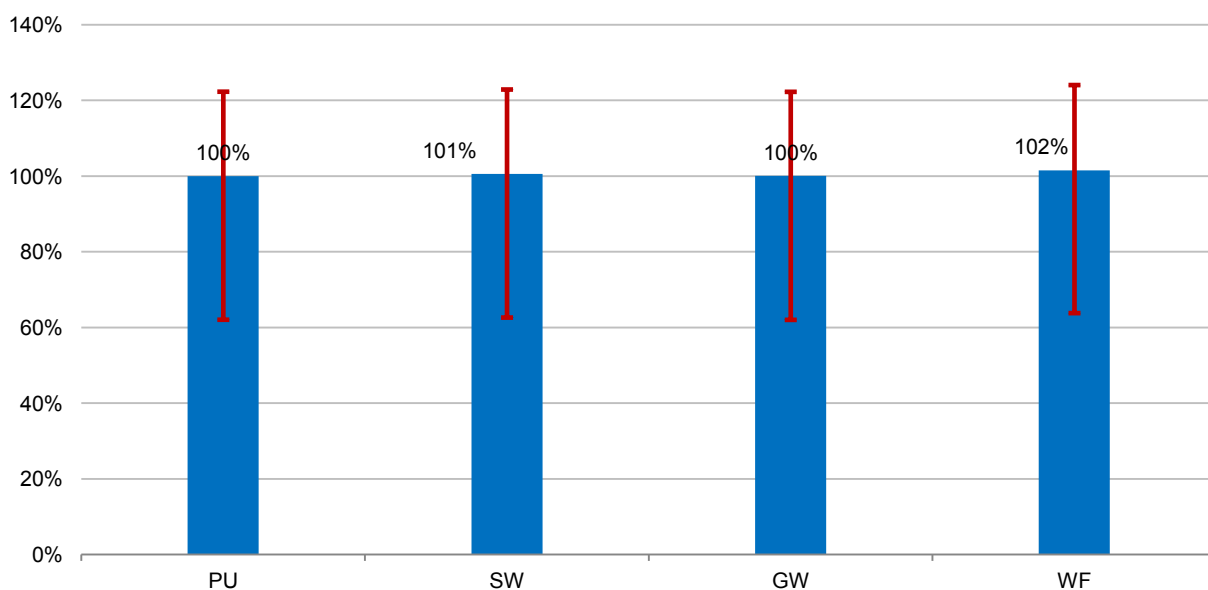

Figure 71 – Sensitivity analysis of the renovation's lifespan on total primary energy

Regarding Total primary energy, the maximum gap between the impact values of the different type of insulation is equal to:

- Less than 1% of the overall results for a 30 year lifespan;
- 2% of the overall results for a 50 year lifespan;
- 1% of the overall results for a 60 year lifespan.

For each different lifespan, the ordering remains the same between the impact values of the different type of insulation.

Climate change

Climate change: variations for 60 and 30 years

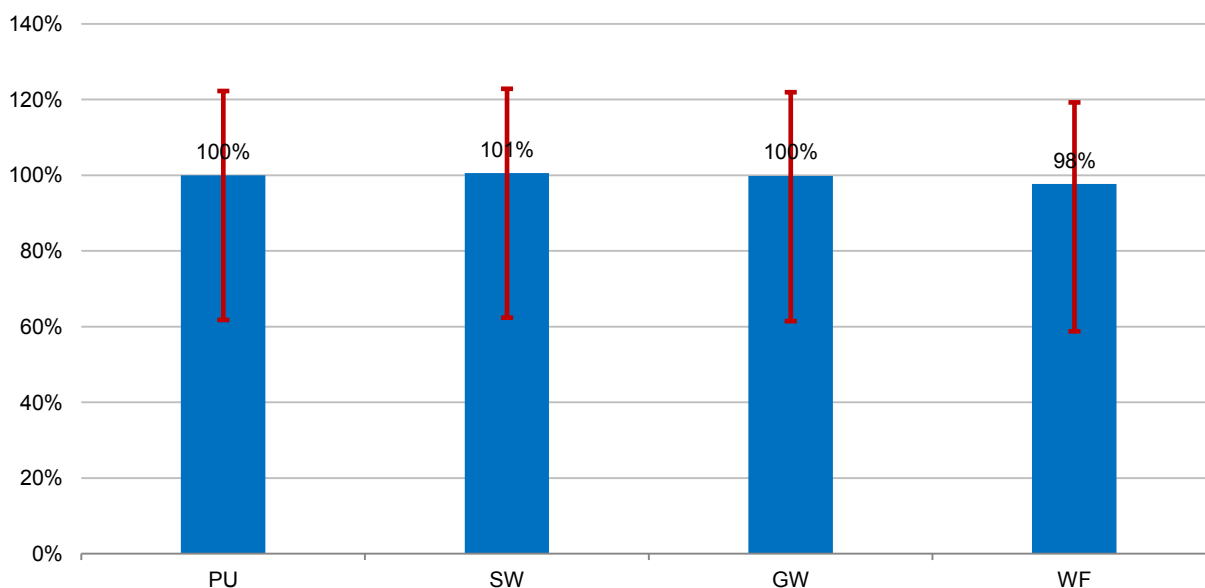

Figure 72 – Sensitivity analysis of the renovation’s lifespan on climate change

Regarding Climate Change, the maximum gap between the impact values of the different type of insulation is equal to:

- 1% of the overall results for a 30 year lifespan;
- 3% of the overall results for a 50 year lifespan;
- Less than 1% of the overall results for a 60 year lifespan.

For each different lifespan, the ordering remains the same between the impact values of the different type of insulation.

8.1.3. Conclusion

The sensitivity analysis shows that, for the studied indicators, the ordering remains between the different scenarios or the different insulation whichever the lifespan chosen.

However, we can notice that for the part A the maximum gap between the impact values of the different scenarios can vary rather significantly – it is reduced between the 30 year and the 50 year lifespan then it grows between the 50 year and the 60 year lifespan. This situation is due to the fact that a great amount of equipments and materials are changed after 50 years of use.

8.2. Comparison between min-max values (part B)

In order to confirm that the choice of the representative EPDs does not affect the overall results of the study, a sensitivity analysis has been conducted for the insulation materials Glass wool and wood fibre.

The methodology followed to determine the representative EPDs is described in 6.4.1.1.2.

8.2.1. Glass wool

Variations on overall results for different Glass Wool EPDs (reference: GR 32 REVETU KRAFT)

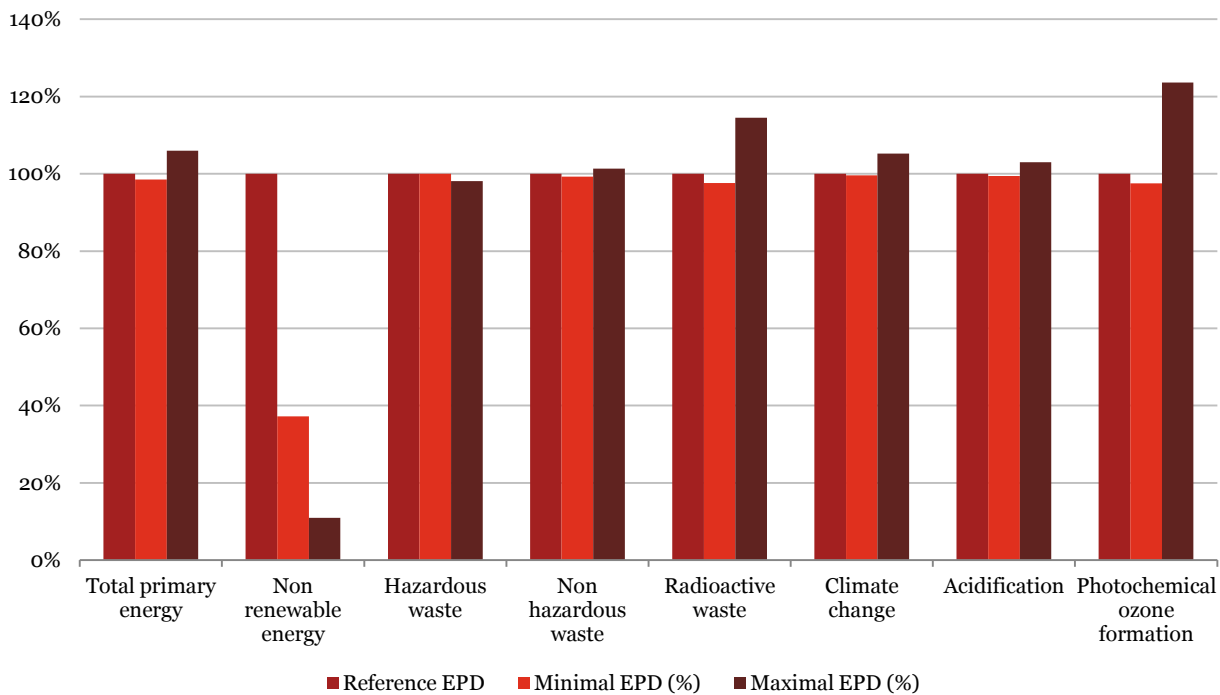

Figure 73 – variations on overall results for different Glass Wool EPDs

This choice is thus confirmed with the above figure as the variations between overall results for these 3 EPDs (average, maximal and minimal) represent less than 10% of the overall results for the indicators Total primary energy, Abiotic depletion, Hazardous and Non Hazardous waste, Climate change and Acidification, which means they are slightly inferior to the overall uncertainties.

8.2.2. Wood fibre

Variations on overall results for two different EPD (reference: PAVATEX)

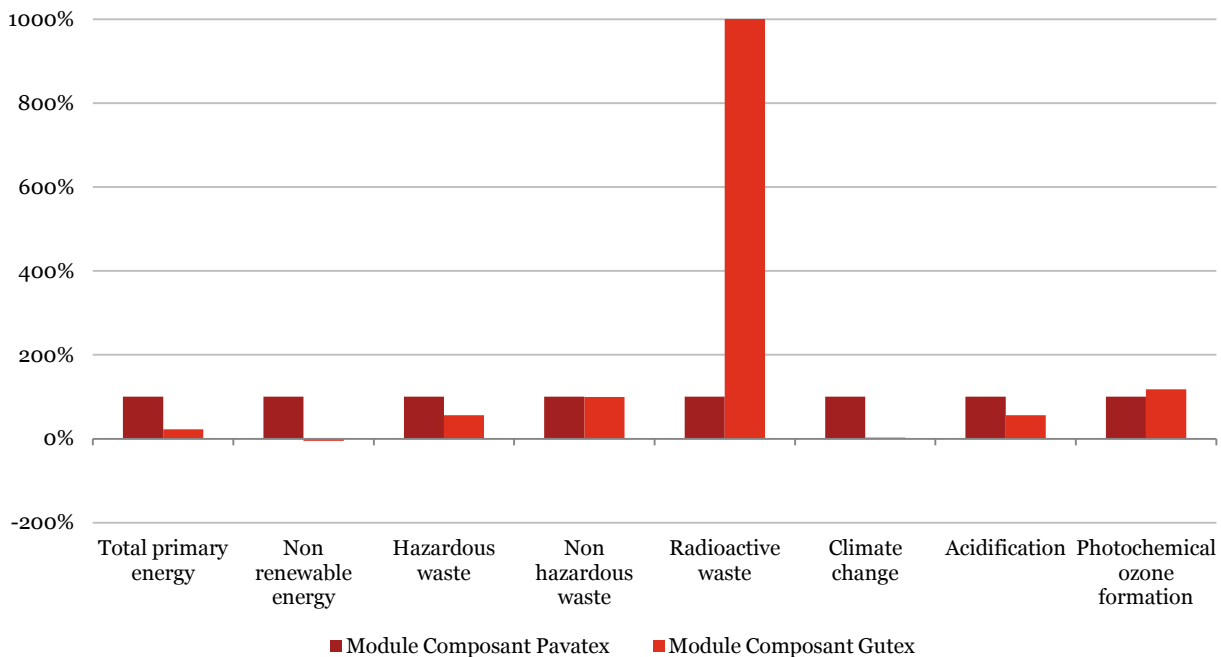

Figure 74 – wood fibre, variations on overall results for two different wood fibre EPDs

On this graph, radioactive wastes for the Gutex EPD are important as the country of reference is Germany, whereas it is Switzerland for the Pavatex EPD. The difference mainly results from the differing energy mixes in these two countries, the latter being widely based on Hydropower.

8.3. Limitations

Any LCA results must come along with an analysis of limitations of the study and its interpretation. Limitations may depend either on initial assumptions (scope, scenarios, indicators...) or on uncertainties.

The present LCA aims at assessing impacts of a building in a “typical European” environment. This approach requires using average data representative of the European market and energy mix. Although all choices were driven according to this approach, LCI data from differing scopes and reference frameworks have been used.

When discrepancies were significant and clearly identified, the interpretation of the results has been excluded although overall results are presented and all detailed results are provided in appendices for a total transparency. This rule has been applied to the indicator on ozone and abiotic depletion once the origin of discrepancy explained, and to the eutrophication indicator because of a lack of data to cover the whole scope. It is also important to consider that since differences between scenarios are only related to insulation materials, thus data used for these products were selected according to strict criteria to ensure the comparability of the results. Whereas LCA model of the existing building, which is common to all scenarios, does not impact the comparability between scenarios.

Overall we can say that different background data have been used: French EPDs (Inies), Elodie’s data (CSTB), German EPDs (IBU), TEAM™ *ad hoc* models. The complete list of data sources is available in Appendix D. -

“Bill of quantities”. The major part of environmental data used were not published according to EN 15804 standard.

EPDs include intrinsic uncertainty and their aggregation adds other sources of discrepancies between the modeled and theoretical building and a real building, which would be constructed in Europe. As a result, **a minimum threshold uncertainty of 20% must be considered when comparing scenarios.**

Regarding the LCC, the risk and the difficulty of such a study essentially arise from the assumptions and the interpretation made for the evolution of the different parameters. These will highly affect the life cycle cost of a project. In particular, the following aspects have a significant impact:

- changes in energy prices;
- changes in water supply and sewerage prices;
- inflation rate;
- discount rate.

However, given that we keep the same assumptions during the whole process, we are confident in the comparability of the results.

9. Conclusions

From both analyses on a new commercial building and a refurbished residential house, no significant variation can be observed on life cycle costs and environmental impacts between the defined scenarios based on different insulation materials: polyurethane foam, stonewool, expanded polystyrene (part A, commercial building), glasswool and wood fibre (part B, renovation of a residential house).

As a result, since an extensive perimeter of a building's life cycle is considered, the choice of the insulation material has not a major impact on total costs and final environmental impacts (ie energy resources depletion, climate change, waste generation...).

These conclusions are similar when considering different cold, moderate or hot European climates and a lifespan of 30, 50 or 60 years.

Environmental impacts are mainly driven by the energy consumption at use stage and most parts of the costs are related to the construction of the structure and to the energy consumption. On the life cycle of a new commercial building (50 years), operational energy consumptions represent 31% of total costs and 90% of total primary energy.

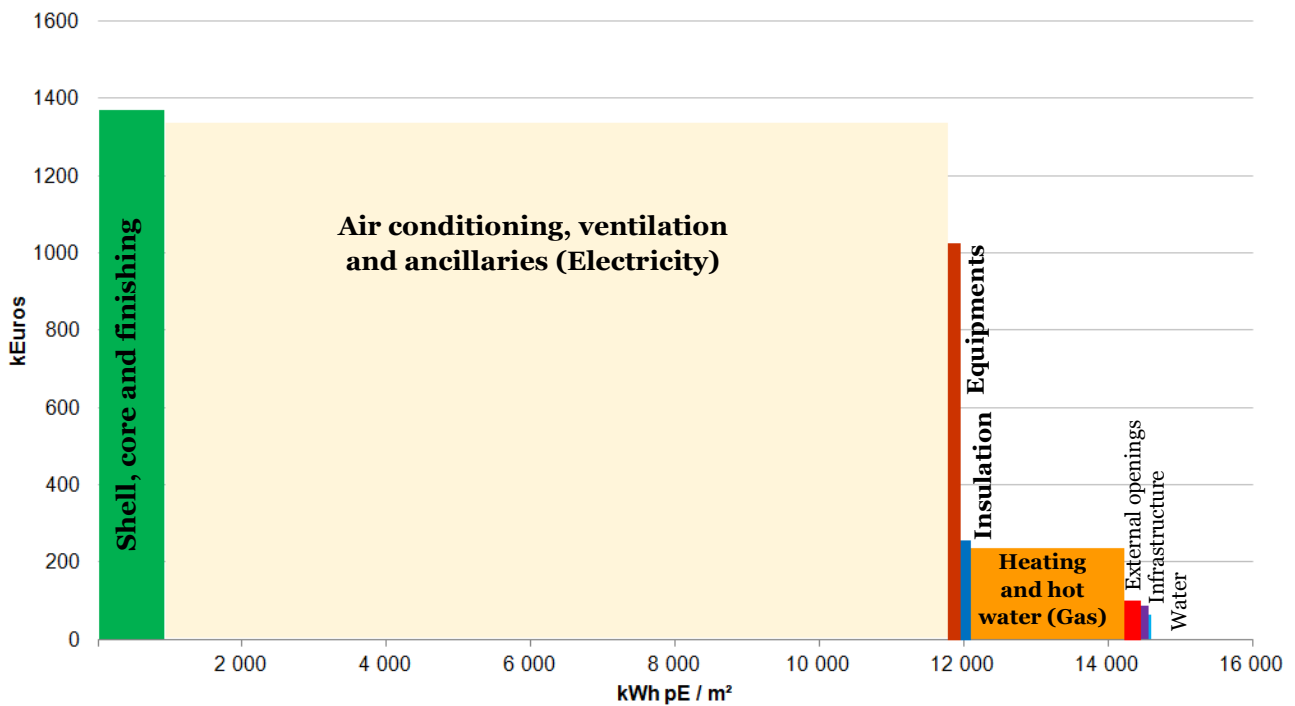

Figure 75 - Total costs and primary energy cross-analysis, part A

Figure 75 summarizes the different contributions. Two distinct types of shapes can be observed: square-shape for electricity and gas consumptions reflects the fact that both impacts on costs and primary energy consumption are important, whereas vertical rectangles (structure and equipments) mean that although their costs are relatively high, their embodied energy remains lower than other contributors.

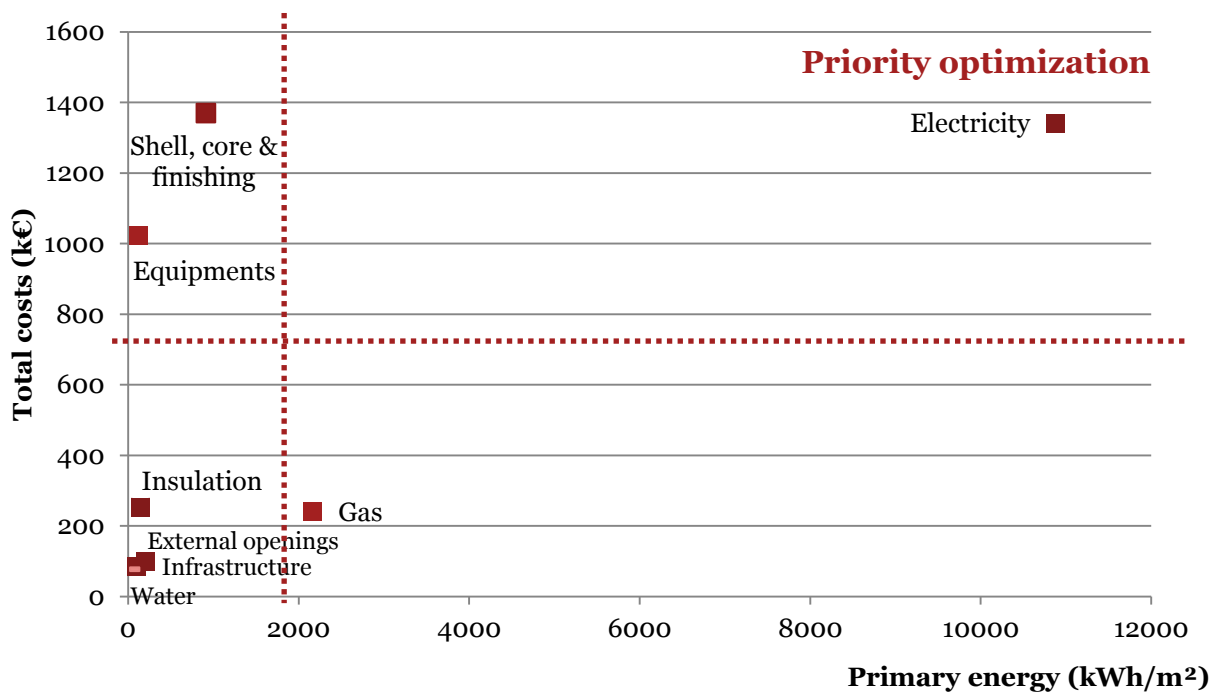

Figure 76 - Total costs and primary energy cross-analysis, part A

On Figure 72, four different regions can be identified to classify the contributors and guide cost and environmental optimization. On the top right is the essential contributor, which must be optimized in priority. The contributors on the top left and down right could be optimized in a second step. They represent relatively expensive components without significant impacts on their own primary energy consumption (top left) or with an important impact on energy and a minor cost contribution (down right).

Figure 72 also highlights the key role of insulation and equipments. Whereas they represent a marginal part of the total primary energy consumption, their effects on thermal performances (heating and cooling needs) and final energy consumptions are significant. Such relations between design choices and cross-impacts and overall performance could be assessed via a consequential life cycle analysis. However, more generally, energy consumptions of the buildings could be downsized by the use of specific design approaches.

The pitched roof renovation scenario of a residential house shows that benefits on operational and, therefore, total costs and environmental impacts would be more substantial if the whole envelope of the house was renovated. Nonetheless, additional impacts due to the renovation on the whole life cycle costs and environmental impacts are not significant.

Some limits to the results and conclusions must be outlined:

- Conclusions are based on theoretical scenarios of building constructions and cannot be considered as general statements.
- Environmental impact analysis is based on a selection of impacts, which do not represent the extensive types of ecological impacts. In particular, water consumption has not been assessed as consistent data were not available.
- LCC and LCA methodologies and data used are associated with a minimum level of uncertainties of 20% when interpreting the results.
- The systems' boundaries exclude some contributors, such as external landscaping and transport of users, which could be of major impacts in particular for a commercial building.

The environmental analysis has also been limited to a series of indicators that were consistent from one insulation product to another since EPDs have not all been calculated according to the same framework. The expected harmonization of EPDs framework in Europe through the EN 15804 standard will help carrying out such comparative LCA, which requires efforts from all building products manufacturers for updating the currently available data.

Finally, when comparing environmental impacts of both commercial and renovated residential buildings to the one of an average European citizen, the importance of some indicators can be put into perspective or reinforced. For example, Figure 77 shows that environmental impacts of the commercial building on its whole life cycle are equivalent to the one of 5 to 25 European citizens in one year.

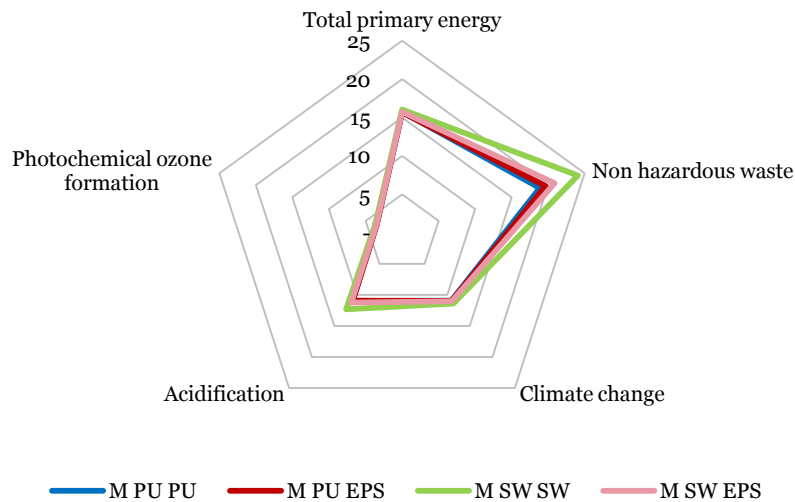

Figure 77 - Part A - Overall results for the moderate climate compared to the impact of one year of a European inhabitant

For the renovated pitched roof scenario, Figure 78 shows that the 50-year life cycle of the residential house only approximately represents one year of a European citizen.

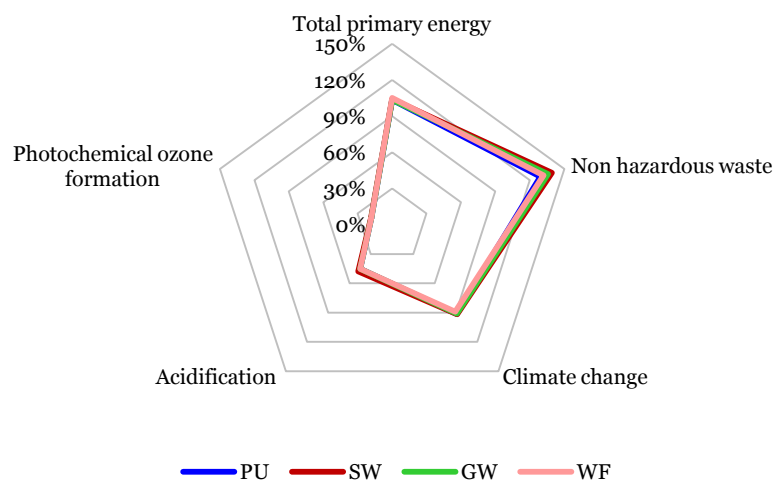

Figure 78 – Part B - Overall results compared to the impact of one year of a European inhabitant

Appendix A. - *References*

EN 15643-1 – Sustainability of construction works – Sustainability assessment of buildings – Part 1: General framework

EN 15643-2 – Sustainability of construction works – Sustainability assessment of buildings – Part 1: General framework

EN 15643-4 – Sustainability of construction works – Sustainability assessment of buildings – Part 1: General framework

EN 15978 – Sustainability of construction works – Assessment of environmental performance of buildings – Calculation method

EN 15804 – Sustainability of construction works – Environmental product declarations – Core rules for the product category of construction products

NF P 01-010 – Environmental quality of construction products – Environmental and health declaration of construction products

ISO 15686-5 – Bâtiments et biens immobiliers construits – Prévission de la durée de vie – Approche en coût global

VDI 2067 – Economic efficiency of building installations – Fundamentals and economic calculation

Life cycle environmental and economic analysis of polyurethane insulation in low energy buildings, BRE Global, March 2010.

Appendix B. - LCA results

B.1. Results part A

Moderate Climate W-PU R-PU

Environmental impacts	Energy resources		Solid waste disposed			Climate change	Acidification	Photochemical ozone formation	
	Total primary energy	Non renewable energy	Hazardous waste	Non hazardous waste	Radioactive waste				
Units	(kWh / m ² / year)	(kWh / m ² / year)	(kg / m ² / year)	(kg / m ² / year)	(kg / m ² / year)	(kg CO ₂ e / m ² / year)	(kg SO ₂ e / m ² / year)	(kg C ₂ H ₄ e / m ² / year)	
Total building	27.35	25.65	0.02	0.62	0.00	8.32	0.03	0.00	
Building	Shell, core & finishing	19.85	18.62	0.01	0.29	0.00	5.66	0.02	0.00
	External openings	1.59	1.39	0.00	0.14	0.00	0.31	0.00	0.00
	Insulation	3.39	3.19	0.00	0.05	0.00	0.67	0.00	0.00
	Equipments	2.53	2.45	0.00	0.24	0.00	1.67	0.00	0.00
Use phase	Gas	43.31	42.91	0.00	0.00	0.00	9.04	0.01	0.00
	Electricity	217.60	202.17	0.00	4.37	0.00	26.55	0.18	0.01
	Water	0.45	0.41	0.00	0.00	0.00	0.04	0.00	0.00
Site work	22.13	21.38	0.00	0.21	0.00	4.65	0.04	0.00	

Moderate Climate W-PU R-EPS

Environmental impacts	Energy resources		Solid waste disposed			Climate change	Acidification	Photochemical ozone formation	
	Total primary energy	Non renewable energy	Hazardous waste	Non hazardous waste	Radioactive waste				
Units	(kWh / m ² / year)	(kWh / m ² / year)	(kg / m ² / year)	(kg / m ² / year)	(kg / m ² / year)	(kg CO ₂ e / m ² / year)	(kg SO ₂ e / m ² / year)	(kg C ₂ H ₄ e / m ² / year)	
Total building	26.78	25.23	0.02	0.70	0.00	8.20	0.03	0.00	
Building	Shell, core & finishing	19.68	18.48	0.01	0.30	0.00	5.38	0.02	0.00
	External openings	1.59	1.39	0.00	0.14	0.00	0.31	0.00	0.00
	Insulation	2.98	2.91	0.00	0.03	0.00	0.83	0.00	0.00
	Equipments	2.53	2.45	0.00	0.24	0.00	1.67	0.00	0.00
Use phase	Gas	43.31	42.91	0.00	0.00	0.00	9.04	0.01	0.00
	Electricity	217.60	202.17	0.00	4.37	0.00	26.55	0.18	0.01
	Water	0.45	0.41	0.00	0.00	0.00	0.04	0.00	0.00
Site work	22.13	21.38	0.00	0.21	0.00	4.65	0.04	0.00	

Moderate Climate W-SW R-SW

Environmental impacts	Energy resources		Solid waste disposed			Climate change	Acidification	Photochemical ozone formation	
	Total primary energy	Non renewable energy	Hazardous waste	Non hazardous waste	Radioactive waste				
Units	(kWh / m ² / year)	(kWh / m ² / year)	(kg / m ² / year)	(kg / m ² / year)	(kg / m ² / year)	(kg CO ₂ e / m ² / year)	(kg SO ₂ e / m ² / year)	(kg C ₂ H ₄ e / m ² / year)	
Total building	32.63	30.51	0.02	1.73	0.00	9.41	0.05	0.00	
Building	Shell, core & finishing	20.45	19.20	0.01	0.30	0.00	5.57	0.02	0.00
	External openings	1.59	1.39	0.00	0.14	0.00	0.31	0.00	0.00
	Insulation	8.05	7.45	0.00	1.05	0.00	1.86	0.03	0.00
	Equipments	2.54	2.46	0.00	0.24	0.00	1.67	0.00	0.00
Use phase	Gas	43.31	42.91	0.00	0.00	0.00	9.04	0.01	0.00
	Electricity	217.60	202.17	0.00	4.37	0.00	26.55	0.18	0.01
	Water	0.45	0.41	0.00	0.00	0.00	0.04	0.00	0.00
Site work	22.13	21.38	0.00	0.21	0.00	4.65	0.04	0.00	

Moderate Climate W-SW R-EPS

Environmental impacts	Energy resources		Solid waste disposed			Climate change	Acidification	Photochemical ozone formation	
	Total primary energy	Non renewable energy	Hazardous waste	Non hazardous waste	Radioactive waste				
Units	(kWh / m ² / year)	(kWh / m ² / year)	(kg / m ² / year)	(kg / m ² / year)	(kg / m ² / year)	(kg CO ₂ e / m ² / year)	(kg SO ₂ e / m ² / year)	(kg C ₂ H ₄ e / m ² / year)	
Total building	28.29	26.60	0.02	1.02	0.00	8.49	0.03	0.00	
Building	Shell, core & finishing	20.02	18.79	0.01	0.30	0.00	5.46	0.02	0.00
	External openings	1.59	1.39	0.00	0.14	0.00	0.31	0.00	0.00
	Insulation	4.14	3.96	0.00	0.34	0.00	1.05	0.01	0.00
	Equipments	2.54	2.46	0.00	0.24	0.00	1.67	0.00	0.00
Use phase	Gas	43.31	42.91	0.00	0.00	0.00	9.04	0.01	0.00
	Electricity	217.60	202.17	0.00	4.37	0.00	26.55	0.18	0.01
	Water	0.45	0.41	0.00	0.00	0.00	0.04	0.00	0.00
Site work	22.13	21.38	0.00	0.21	0.00	4.65	0.04	0.00	

B.2. Results part B

Existing building

Environmental impacts	Energy resources		Solid waste disposed			Climate change	Acidification	Photochemical ozone formation	
	Total primary energy	Non renewable energy	Hazardous waste	Non hazardous waste	Radioactive waste				
Units	(kWh / m ²)	(kWh / m ²)	(kg / m ²)	(kg / m ²)	(kg / m ²)	(kg CO ₂ e / m ²)	(kg SO ₂ e / m ²)	(kg C ₂ H ₄ e / m ²)	
Total building	2.45E+03	1.79E+03	3.56E+00	2.16E+02	3.61E-02	3.54E+02	2.81E+00	2.72E-01	
Valeurs	Shell, core & finishing (existing)	1.57E+03	1.13E+03	8.13E-01	1.62E+02	2.63E-02	2.64E+02	1.31E+00	2.15E-01
	External openings (existing)	4.78E+02	2.79E+02	2.66E+00	1.32E+01	5.05E-03	-1.47E-01	3.27E-01	2.59E-02
	Insulation (existing)	2.64E+02	2.45E+02	5.67E-02	3.77E+01	4.25E-03	6.17E+01	9.90E-01	1.88E-02
	Equipments (existing)	1.41E+02	1.32E+02	3.29E-02	3.21E+00	4.56E-04	2.84E+01	1.77E-01	1.17E-02
%	Shell, core & finishing (existing)	63.94%	63.40%	22.81%	74.94%	72.96%	74.58%	46.79%	79.22%
	External openings (existing)	19.51%	15.56%	74.67%	6.12%	14.00%	-0.04%	11.64%	9.53%
	Insulation (existing)	10.80%	13.69%	1.59%	17.45%	11.78%	17.43%	35.26%	6.93%
	Equipments (existing)	5.74%	7.35%	0.92%	1.48%	1.26%	8.03%	6.31%	4.32%

PU renovation

Environmental impacts	Energy resources		Solid waste disposed			Climate change	Acidification	Photochemical ozone formation	
	Total primary energy	renewable energy	Hazardous waste	hazardous waste	Radioactive waste				
Units	(kWh / m ²)	(kWh / m ²)	(kg / m ²)	(kg / m ²)	(kg / m ²)	(kg CO ₂ e / m ²)	(kg SO ₂ e / m ²)	(kg C ₂ H ₄ e / m ²)	
Total renovation	1.08E+02	9.60E+01	4.15E-02	-3.91E-01	3.12E-03	2.18E+01	7.10E-02	9.20E-03	
Valeurs	Shell, core & finishing (renovation)	7.46E+01	6.54E+01	2.57E-02	3.64E+00	8.92E-04	1.06E+01	5.18E-02	5.78E-03
	External openings (renovation)	0.00E+00	0.00E+00	0.00E+00	0.00E+00	0.00E+00	0.00E+00	0.00E+00	0.00E+00
	Insulation (renovation)	3.34E+01	3.06E+01	1.59E-02	-4.03E+00	2.23E-03	1.12E+01	1.92E-02	3.42E-03
	Equipments (renovation)	0.00E+00	0.00E+00	0.00E+00	0.00E+00	0.00E+00	0.00E+00	0.00E+00	0.00E+00
%	Shell, core & finishing (renovation)	69.06%	68.11%	61.79%	-931.39%	28.61%	48.47%	72.98%	62.84%
	External openings (renovation)	0.00%	0.00%	0.00%	0.00%	0.00%	0.00%	0.00%	0.00%
	Insulation (renovation)	30.94%	31.89%	38.21%	1031.39%	71.39%	51.53%	27.02%	37.16%
	Equipments (renovation)	0.00%	0.00%	0.00%	0.00%	0.00%	0.00%	0.00%	0.00%

SW renovation

Environmental impacts		Energy resources		Solid waste disposed			Climate change	Acidification	Photochemical ozone formation
		Total primary energy	renewable energy	Hazardous waste	hazardous waste	Radioactive waste			
Units		(kWh / m ²)	(kWh / m ²)	(kg / m ²)	(kg / m ²)	(kg / m ²)	(kg CO2e / m ²)	(kg SO2e / m ²)	(kg C2H4e / m ²)
Total renovation		2.03E+02	1.84E+02	5.32E-02	2.21E+01	2.97E-03	4.06E+01	5.35E-01	1.50E-02
Valeurs	Shell, core & finishing (renovation)	7.46E+01	6.54E+01	2.57E-02	3.64E+00	8.92E-04	1.06E+01	5.18E-02	5.78E-03
	External openings (renovation)	0.00E+00	0.00E+00	0.00E+00	0.00E+00	0.00E+00	0.00E+00	0.00E+00	0.00E+00
	Insulation (renovation)	1.28E+02	1.19E+02	2.76E-02	1.84E+01	2.07E-03	3.00E+01	4.83E-01	9.17E-03
	Equipments (renovation)	0.00E+00	0.00E+00	0.00E+00	0.00E+00	0.00E+00	0.00E+00	0.00E+00	0.00E+00
%	Shell, core & finishing (renovation)	36.79%	35.51%	48.18%	16.49%	30.07%	25.99%	9.69%	38.69%
	External openings (renovation)	0.00%	0.00%	0.00%	0.00%	0.00%	0.00%	0.00%	0.00%
	Insulation (renovation)	63.21%	64.49%	51.82%	83.51%	69.93%	74.01%	90.31%	61.31%
	Equipments (renovation)	0.00%	0.00%	0.00%	0.00%	0.00%	0.00%	0.00%	0.00%

GW renovation

Environmental impacts		Energy resources		Solid waste disposed			Climate change	Acidification	Photochemical ozone formation
		Total primary energy	renewable energy	Hazardous waste	hazardous waste	Radioactive waste			
Units		(kWh / m ²)	(kWh / m ²)	(kg / m ²)	(kg / m ²)	(kg / m ²)	(kg CO2e / m ²)	(kg SO2e / m ²)	(kg C2H4e / m ²)
Total renovation		1.18E+02	1.06E+02	7.33E-02	1.47E+01	1.87E-03	1.62E+01	8.69E-02	8.47E-03
Valeurs	Shell, core & finishing (renovation)	8.44E+01	7.48E+01	6.10E-02	1.17E+01	1.12E-03	1.23E+01	6.24E-02	6.77E-03
	External openings (renovation)	0.00E+00	0.00E+00	0.00E+00	0.00E+00	0.00E+00	0.00E+00	0.00E+00	0.00E+00
	Insulation (renovation)	3.32E+01	3.09E+01	1.22E-02	2.96E+00	7.41E-04	3.85E+00	2.44E-02	1.70E-03
	Equipments (renovation)	0.00E+00	0.00E+00	0.00E+00	0.00E+00	0.00E+00	0.00E+00	0.00E+00	0.00E+00
%	Shell, core & finishing (renovation)	71.78%	70.74%	83.29%	79.80%	60.26%	76.19%	71.87%	79.91%
	External openings (renovation)	0.00%	0.00%	0.00%	0.00%	0.00%	0.00%	0.00%	0.00%
	Insulation (renovation)	28.22%	29.26%	16.71%	20.20%	39.74%	23.81%	28.13%	20.09%
	Equipments (renovation)	0.00%	0.00%	0.00%	0.00%	0.00%	0.00%	0.00%	0.00%

WF renovation

Environmental impacts		Energy resources		Solid waste disposed			Climate change	Acidification	Photochemical ozone formation
		Total primary energy	renewable energy	Hazardous waste	hazardous waste	Radioactive waste			
Units		(kWh / m ²)	(kWh / m ²)	(kg / m ²)	(kg / m ²)	(kg / m ²)	(kg CO2e / m ²)	(kg SO2e / m ²)	(kg C2H4e / m ²)
Total renovation		3.66E+02	-2.49E+02	1.00E-01	6.17E+00	-1.61E-04	-5.59E+01	8.62E-02	6.59E-03
Valeurs	Shell, core & finishing (renovation)	7.46E+01	6.54E+01	2.57E-02	3.64E+00	8.92E-04	1.06E+01	5.18E-02	5.78E-03
	External openings (renovation)	0.00E+00	0.00E+00	0.00E+00	0.00E+00	0.00E+00	0.00E+00	0.00E+00	0.00E+00
	Insulation (renovation)	2.92E+02	-3.14E+02	7.45E-02	2.53E+00	-1.05E-03	-6.64E+01	3.44E-02	8.06E-04
	Equipments (renovation)	0.00E+00	0.00E+00	0.00E+00	0.00E+00	0.00E+00	0.00E+00	0.00E+00	0.00E+00
%	Shell, core & finishing (renovation)	20.38%	-26.24%	25.62%	58.97%	-553.27%	-18.88%	60.09%	87.77%
	External openings (renovation)	0.00%	0.00%	0.00%	0.00%	0.00%	0.00%	0.00%	0.00%
	Insulation (renovation)	79.62%	126.24%	74.38%	41.03%	653.27%	118.88%	39.91%	12.23%
	Equipments (renovation)	0.00%	0.00%	0.00%	0.00%	0.00%	0.00%	0.00%	0.00%

Appendix C. - Buildings description and thermal performance

C.1. Part A

C.1.1. Building summary

The table below summarizes the main assumptions for the commercial building model. More details are given in the next chapter.

Part A Commercial Building

Description	Value	Data Source
Building Summary		
Program		
Building Name	Retail Reference Building new	DOE Com. Ref. Buil.
Available Fuel Types	Gas, electricity	DOE Com. Ref. Buil.
Principal Building Activity	Retail	DOE Com. Ref. Buil.
Form		
Total net floor area (including internal wall and structure)	2294 m ²	DOE Com. Ref. Buil.
Building Shape	Rectangle	DOE Com. Ref. Buil.
Aspect Ratio (width/depth)	1.3	DOE Com. Ref. Buil.
Number of Floors	1	DOE Com. Ref. Buil.
Window Fraction (Window to Wall Ratio)		DOE Com. Ref. Buil.
South	0.254	DOE Com. Ref. Buil.
East	0	DOE Com. Ref. Buil.
North	0	DOE Com. Ref. Buil.
West	0	DOE Com. Ref. Buil.
Total	0.071	DOE Com. Ref. Buil.
Skylight/Tubular Daylighting Device Percentage	None	DOE Com. Ref. Buil.
Shading Geometry	None	DOE Com. Ref. Buil.
Azimuth	0	DOE Com. Ref. Buil.
Thermal Zoning	Back, CoreRetail, FrontRetail, PointofSale, FrontEntry	DOE Com. Ref. Buil.
Floor to Ceiling Height (m)	6.1	DOE Com. Ref. Buil.
Roof type	Flat roof, insulation entirely above deck	DOE Com. Ref. Buil.
Exterior walls		
Construction Type	Steel frame with sandwich panels	Study requirement
Roof		
Construction Type	Insulation entirely above deck	DOE Com. Ref. Buil.
Window Dimensions (m²)		
South	83.9	DOE Com. Ref. Buil. (2 * 25.03*1.52m + 3*2.61m)

East	0	DOE Com. Ref. Buil.
North	0	DOE Com. Ref. Buil.
West	0	DOE Com. Ref. Buil.
Total Area (m2)	83.9	DOE Com. Ref. Buil.
Operable area (m2)	0	DOE Com. Ref. Buil.

Part A Commercial Building

Description	Value	Data Source
Skylights/TDD		
Dimensions - Total Area (m2)	0	DOE Com. Ref. Buil.
Operable area (m2)	0	DOE Com. Ref. Buil.
Foundation		
Foundation Type	Ponctual, under the steel frame	PwC proposition
Construction	Slab-on-grade	PwC proposition
Internal dimensions - Total Area (m2)	2294	DOE Com. Ref. Buil.
Interior Partitions		
Construction	Concrete bloc and metal structure	PwC proposition
Internal Mass	244.23	DOE Com. Ref. Buil.
Dimensions - Total Area (m2)	7764.95	DOE Com. Ref. Buil.
Thermal diffusivity (m2/s)	1.84E-07	DOE Com. Ref. Buil.
Air Barrier System	See drawings	PwC proposition
Infiltration (ACH)	0.2	Based on an average pressure difference of 4 Pa
Infiltration q50 (m ³ /h.m ²)	2.6	Based on 5m ³ /h.m ² for sandwich panels and 2m ³ /h.m ² for roof and slab
Thermal bridges		
T.B. heat losses added to foreseen elements	15%	PwC proposition (based on Kingspan study and experience knowledge)
HVAC system		
Heating and cooling distribution system	4-pipe fan coil	PwC proposition
Heating production	Condensing Gas boiler	PwC proposition
Cooling production	Monobloc chiller	PwC proposition
Refrigerant type	R407C	PwC proposition
Air handling unit (AHU)	Dedicated outdoor air system with plate heat recovery	PwC proposition
Fan Control	Constant volume	PwC proposition
Sensible heat recovery	70%	PwC proposition
Service Water Heating	10Wh/m ² .day	DIN 18599
SWH Type	Centralized hot water production	PwC proposition
Hot water storage [litres]	160 litres	PwC proposition
Fuel	Gas	PwC proposition
Thermal Efficiency (%)	90%	PwC proposition

Water Consumption (L)

DHW : 100 m³/y
Cold water (DHW included): 574 m³

PwC proposition based on DIN 18599
and experience value of 1l/m².day for
water

Table 28: building main characteristics

C.1.2. Building drawings

Based on the definition of the reference building and on the requirements of the study, drawings of the building are presented below and are appended for better visibility.

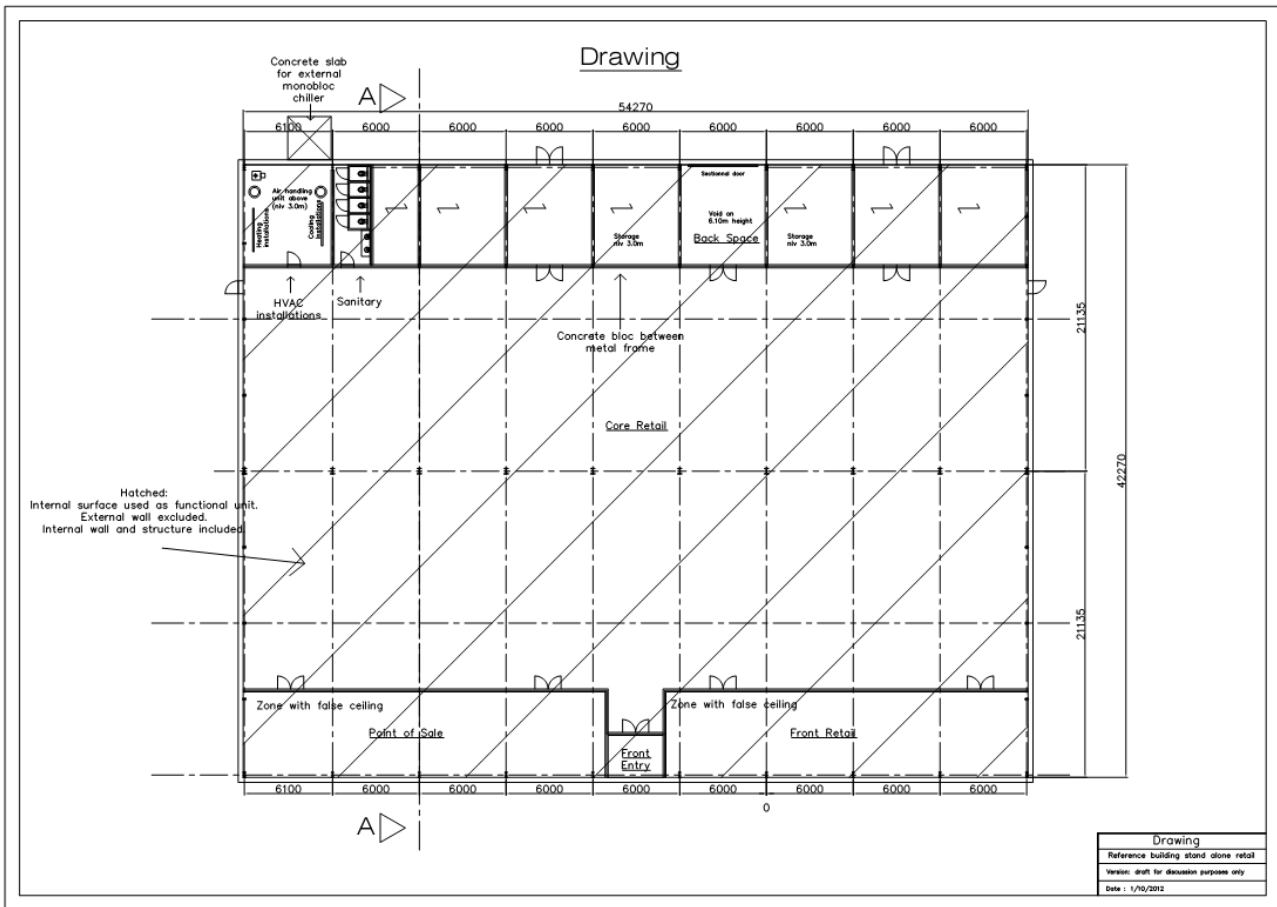

Figure 79: Commercial reference building - Plan view

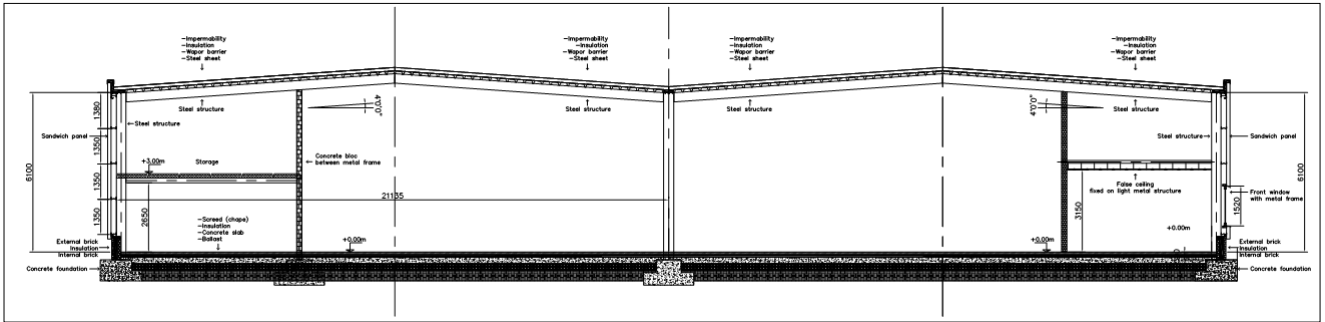

Figure 80: Commercial reference building - AA section drawing

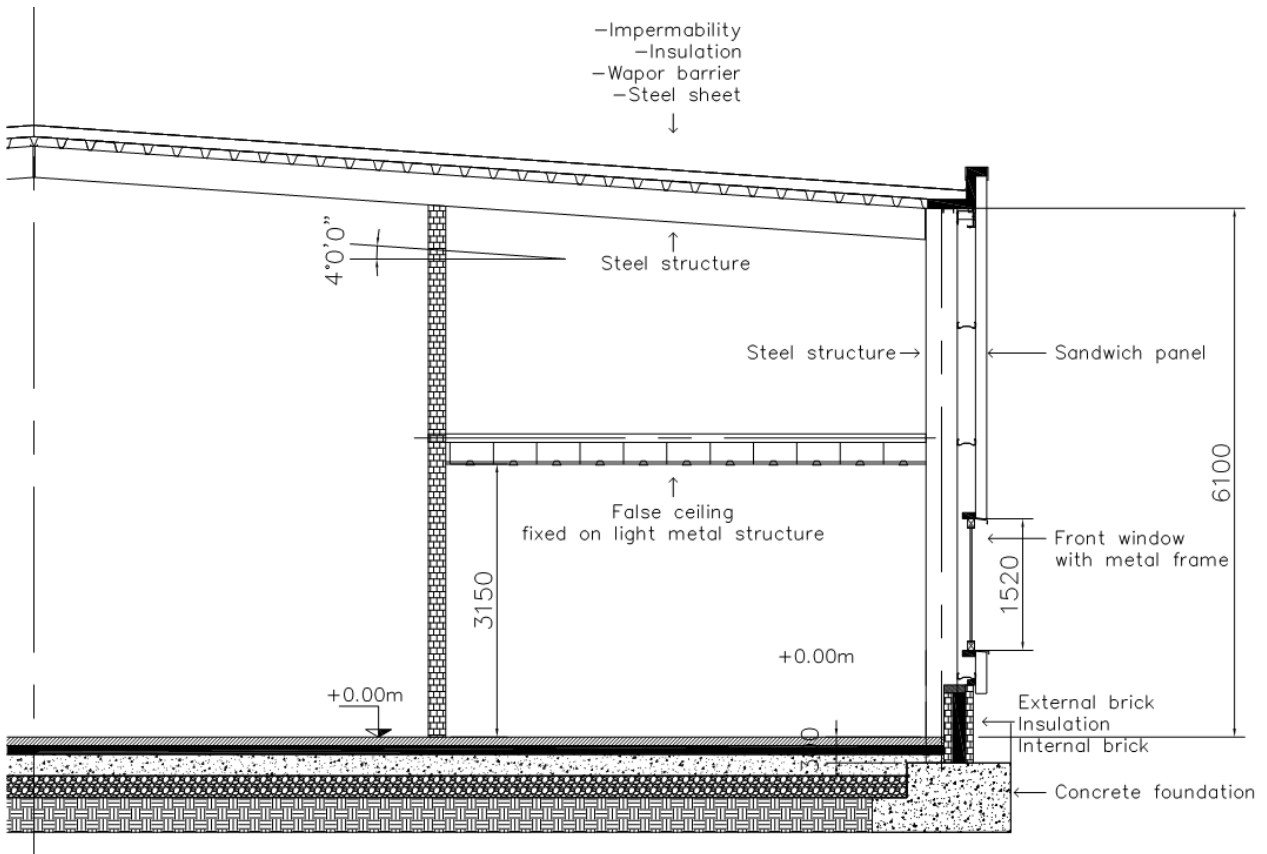

Figure 81: Commercial reference building - AA Section drawing (front)

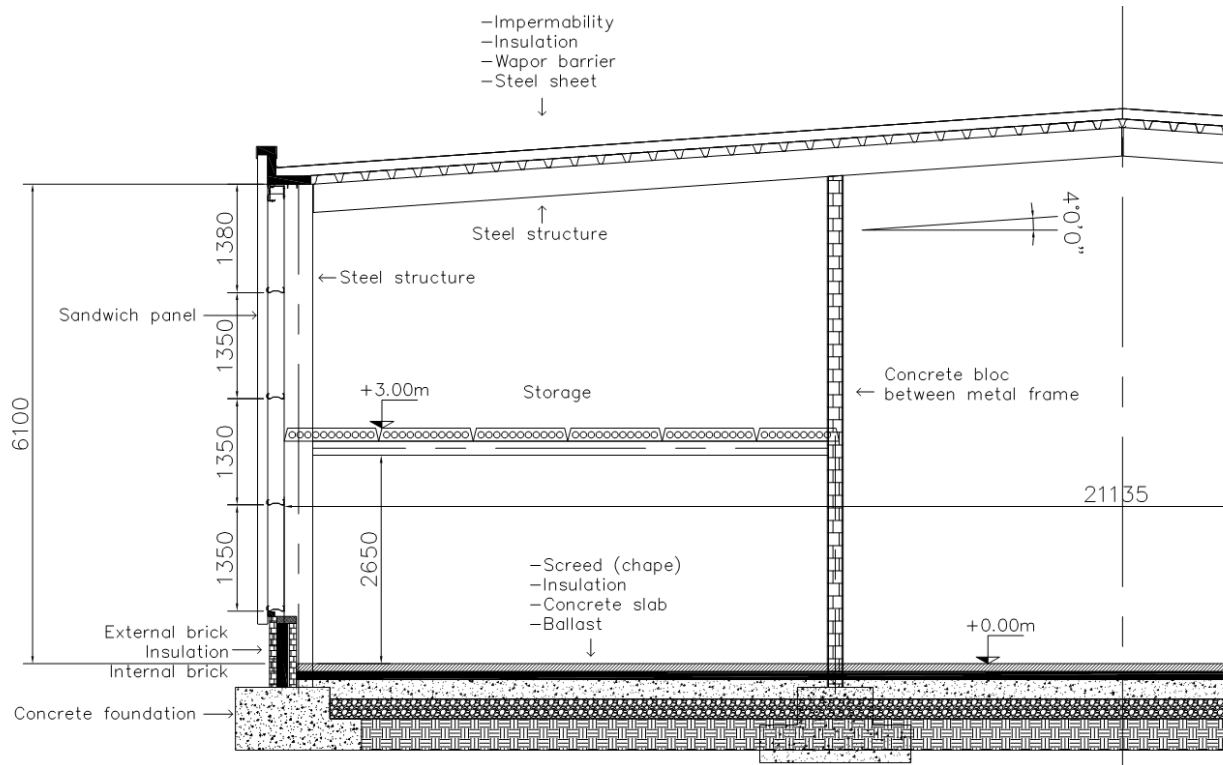

Figure 82: Commercial reference building - AA Section drawing (back)

C.1.3. Thermal envelope

Opaque walls

The following tables have been used to calculate insulation width.

	Insulation material	Density [kg/m ³]	Lambda [W/m.K]	U Value [W/m ² .K]	Theoretical Width [m]	Real Width [m]	Real U value W/m ² .K
External Walls							
	PU	40	0.022	0.17	0.130	0.130	0.170
Cold Continental	SW	110	0.040	0.17	0.240	0.240	0.170
	PU	40	0.022	0.17	0.130	0.130	0.170
Moderate	SW	110	0.040	0.17	0.240	0.240	0.170
	PU	40	0.022	0.23	0.100	0.100	0.230
Mediterranean	SW	110	0.040	0.23	0.170	0.170	0.230
Flat Roof							
	PU	32	0.023	0.07	0.325	0.330	0.069
	SW	150	0.040	0.07	0.566	0.570	0.069
Cold Continental	EPS	25	0.035	0.07	0.495	0.500	0.069
Moderate	PU	32	0.023	0.16	0.141	0.145	0.155

	SW	150	0.040	0.16	0.244	0.250	0.156
	EPS	25	0.035	0.16	0.214	0.220	0.156
	PU	32	0.023	0.18	0.125	0.130	0.173
	SW	150	0.040	0.18	0.217	0.220	0.177
Mediterranean	EPS	25	0.035	0.18	0.190	0.195	0.175

Ground floor

Cold Continental	PU	32	0.023	0.17	0.131	0.120	0.186
Moderate	PU	32	0.023	0.17	0.131	0.120	0.186
Mediterranean	PU	32	0.023	0.35	0.062	0.060	0.360

Table 29: thermal envelope for part A

The internal and external superficial thermal resistances are included in the computation.

Regarding U-values calculations, it is important to mention that:

- the use of different insulation materials leads to slight differences in the real U-values of components. However, we will ignore the impact of these differences on the energy consumption;
- U-value deterioration due to fixations are included in thermal bridges and not in U-values;
- for the ground floor, the U-values are proposed by PwC.

Windows

The proposed definitions of windows are listed below. The average data for U-value, SHGC (solar heat gain coefficient) and T.L. (lighting transmittance) will be directly integrated into the thermal simulation model.

	Dimensions (Inclusive frame)		Frame			Glass				WindowMaterial: SimpleGlazingSystem		
	Width [m]	Height [m]	Width [m]	Height [m]	U [W/m ² .K]	T.L [%]	SHGC [%]	U-Value [W/m ² .K]	Psi [W/m.K]	U Factor [W/m ² .K]	SHGC [%]	T.L [%]
Cold Continental												
Window type 1 (band of window)	2.50	1.52	0.12	0.10	1.20	70.0%	50.0%	0.5	0.04	0.77	39.3%	55.0%
Window type 2 (Window-door)	1.50	2.61	0.12	0.10	1.20	70.0%	50.0%	0.5	0.04	0.76	38.8%	54.3%
Moderate												
Window type 1 (band of window)	2.50	1.52	0.12	0.10	1.40	70.0%	50.0%	0.7	0.042	0.98	39.3%	55.0%
Window type 2 (Window-door)	1.50	2.61	0.12	0.10	1.40	70.0%	50.0%	0.7	0.042	0.97	38.8%	54.3%
Mediterranean												
Window type 1 (band of window)	2.50	1.52	0.12	0.10	1.70	80.0%	60.0%	1.1	0.05	1.39	47.1%	62.8%
Window type 2 (Window-door)	1.50	2.61	0.12	0.10	1.70	80.0%	60.0%	1.1	0.05	1.37	46.5%	62.1%

Table 30: windows characteristics

We can mention that:

- U-value for Cold continental climate (0.5W/m².K) implies that the building is fitted with high performance triple glazing;
- U-value for Moderate climate (0.7W/m².K) implies that the building is fitted with standard triple glazed windows;

- U-value for Mediterranean climate (1.1W/m².K) implies that the building is fitted with standard double glazed windows.

Thermal bridges

15% additional losses through the envelope have been added to take thermal bridges into account. This represents about 0.025 W/m².K for a well-insulated building (compared to 0.05W/m².K following the standard DIN 4108-6 on construction details).

The value is relatively low compared to Kingspan's study⁵ for a well-insulated building with sandwich panels: about 22% additional losses or 0.049W/m².K. However, the regulations become more and more ambitious and, for example, the max additional losses are fixed at +10% in the U.K. The value of +15% is thus in line with the construction type.

Infiltrations

According to the Kingspan's study, infiltrations for sandwich panels are about 5m³/h.m², at 50Pa. This value is significant when dealing with well-insulated buildings. The losses due to infiltrations are thus important. For roof and concrete slabs, the infiltration should be lower: about 2m³/h.m² at 50Pa. A weighted average has been calculated based on these data.

C.1.4. Steel structure sizing

Building statics have been studied in a separate report in order to assess the impact of insulation weight on the steel structure. The table below shows the weight considered for roof insulation and sandwich panels:

	Insulation material	Density [kg/m ³]	Lambda [W/m.K]	U Value [W/m ² .K]	Real Width [m]	Real U value [W/m ² .K]	Insulation weight [kg/m ²]	Inner + Outer metal sheet width [m]	Steel (sandwich panel only) weight [kg/m ²]	Total weight [kg/m ²]
External wall (Sandwich panels)	PU	45	0,023	0,17	0,135	0,166	6,1	0,0012	8,4	14,5
	SW	85	0,038	0,17	0,22	0,169	18,7	0,0012	8,4	27,1
Flat Roof	PU	32	0,023	0,16	0,145	0,155	4,6	-		4,6
	SW	150	0,04	0,16	0,25	0,1560	37,5	-		37,5

Table 31: weight considered for structure sizing

Other climatic impacts (such as snow, wind, etc.) are also taken into account for each climate. Snow loads that have been considered are in accordance with Eurocode 1991-1-3. The normative values vary with the altitude, the slope of the roof, the wind exposure, etc. They are summarised in the table below.

Climate	Snow load (kN/m ²)
Méditerranéan (Rome) Altitude <200m	0,92
Moderate (Brussels) Altitude >100m	0,64
Cold continental	2,40

⁵ Kingspan technical guide 2012, p 133 (FR)

(Helsinki)	
------------	--

Table 32: snow loads for each climate

Following the Eurocode, the snow load is higher in Rome than in Brussels.

Considering these loads and other assumptions (see complete building statics study Appendix G. -) the results in structure sizing vary significantly for the different scenarios due to insulation and snow loads. The results for trapezoidal roofing sheets and rafters are presented hereafter.

Trapezoidal roofing sheets

Summary of loads acting on sheets:

	Brussels kN/m ²	Rome kN/m ²	Helsinki kN/m ²
<u>Permanent loads</u>			
Waterproofing membrane (bitumen)	0.0625	0.0625	0.0625
PU insulation (case 1)	0.048	0.048	0.048
SW insulation (case 2)	0.375	0.375	0.375
<u>Variable overloads</u>			
Snow	0.64	0.92	2.40
Wind	-0.53	-0.53	-0.53
Roof maintenance (weight of a man)	0.80	0.80	0.80

Table 33: loads for trapezoidal roofing sheets sizing

Roofing sheet characteristics:

Sheet thickness mm	MP100.275/3 kg/m ²	MP106.250/3 kg/m ²	MP135.310/3 kg/m ²	MP150.280/3 kg/m ²
0.75	8.85	9.73	9.50	10.51
0.88	10.38	11.42	11.14	12.34
1.00	11.80	12.98	12.66	14.02

Table 34: characteristics of trapezoidal roofing sheets

Results for each climate:

Brussels

Sheet thickness	Admissible maximum span [m]					
	0,75mm		0,88mm		1,00mm	
	PU	SW	PU	SW	PU	SW
MP100.275/3	5.50	4.50	5.75	5.25	6.00	5.50
MP106.250/3	6.00	5.25	6.25	5.75	6.50	6.00
MP135.310/3	6.25	5.25	7.00	6.25	7.00	6.25
MP150.280/3	7.50	6.25	8.00	7.25	8.00	7.50

Rome

Sheet thickness	Admissible maximum span [m]					
	0,75mm		0,88mm		1,00mm	
	PU	SW	PU	SW	PU	SW
Type of sheet	PU	SW	PU	SW	PU	SW

MP100.275/3	4.75	4.00	5.25	4.75	5.50	5.00
MP106.250/3	5.25	4.50	5.75	5.25	6.00	5.50
MP135.310/3	5.25	4.50	6.25	5.50	6.75	6.25
MP150.280/3	6.25	5.50	7.25	6.50	7.50	7.00

Helsinki

Sheet thickness	Admissible maximum span [m]					
	0,75mm		0,88mm		1,00mm	
	PU	SW	PU	SW	PU	SW
Type of sheet						
MP100.275/3	-	-	3.25	3.00	3.75	3.50
MP106.250/3	-	-	3.75	3.50	4.00	3.75
MP135.310/3	-	-	4.25	4.00	4.25	4.00
MP150.280/3	-	-	4.75	4.50	5.25	5.00

Table 35: results of trapezoidal roofing sheets sizing

The center-to-center distance considered for external columns and rafters of the building is 6 m. Tables above shows that for Brussels, a MP135.310/3 sheet with a weight of 9.5 kg/m² will suit for PU whereas a MP150.280/3 sheet with a weight of 10.51 kg/m² is needed with SW. For greater inter-axis distance, thicker sheets or additional purlins are required.

Globally, the use of PU leads to a decrease of about 10% of the steel sheet weight, but the impact of the snow is also significant. For Helsinki, no sheet is satisfying the sizing criteria. In this case, additional purlins are needed.

Finally, purlins are chosen for each scenario in order to deal with wind impact. Purlins and sheets sizing can be found in Appendix G. -

Rafters

For rafters sizing, all roof elements (waterproofing membrane, insulation, sheets and purlins) but also the loads due to maintenance, snow and wind are taken into account.

The results are detailed in the table below:

Brussels/Rome		Distance between rafters [m]					
PU insulation		6m		7m		8m	
Msd max (kNm)		441.72		512.09		588.93	
Wpl (cm ³)		2162		2506		2882	
Type of rafters required		HEA 400	125,0 kg/m	HEA 400	125,0 kg/m	HEA 450	140,0 kg/m
		HEB 340	134,0 kg/m	HEB 360	142,0 kg/m	HEB 400	155,0 kg/m
SW insulation		6m		7m		8m	
Msd max (kNm)		536.37		625.75		715.12	
Wpl (cm ³)		2625		3062		3500	
Type of rafters required		HEA 450	140,0 kg/m	HEA 450	140,0 kg/m	HEA 500	155,0 kg/m
		HEB 360	142,0 kg/m	HEB 400	155,0 kg/m	HEB 450	171,0 kg/m
Helsinki		Distance between rafters [m]					
PU insulation		6m		7m		8m	
Msd max (kNm)		961.79		1122.05		1282.35	
Wpl (cm ³)		4707		5491		6275	
Type of rafters required		HEA 600	178,0 kg/m	HEA 650	190,0 kg/m	HEA 700	204,0 kg/m
		HEB 500	187,0 kg/m	HEB 550	199,0 kg/m	HEB 600	212,0 kg/m

SW insulation						
Msd max (kNm)	1057.7		1234		1410.28	
Wpl (cm ³)	5176		6039		6901	
Type of rafters required	HEA 600	178,0 kg/m	HEA 650	190,0 kg/m	HEA 700	204,0 kg/m
	HEB 550	199,0 kg/m	HEB 600	212,0 kg/m	HEB 650	225,0 kg/m

Table 36: results of rafters sizing

Again, the use of PU leads to a decrease of about 10% of the steel sheet weight. The same rafters can be used for PU or SW insulation in Helsinki. The impact of insulation weight is diluted in the high effect of snow loads.

The detailed results, including sizing of other elements of the structure are in Appendix G. -

The table below shows the impact of insulation weight on the steel structure sizing. Only insulation of the roof is considered.

Climate	Cold continental	Moderate	Mediterranean
Snow [kg/m²]*	244.65	65.24	93.78
Bitumen [kg/m²]	6.25	6.25	6.25
Steel sheet [kg/m²]	PU: 12.3 SW: 14.0	PU: 9.5 SW: 10.5	PU: 9.5 SW: 10.5
PU [kg/m²]**	10.56	4.64	4.16
PU/(total)	3.8%	5.4%	3.7%
SW [kg/m²]**	85.5	37.5	33.0
SW/(total)	24.4%	31.4%	23.0%

* According to Eurocode1991-1-3

** Insulation of the roof only

Table 37: impact of insulation weight of the structure sizing

Snow loads have the biggest impact on the structure sizing. PU impact is only 4 to 5% depending on climate. SW impact on the structure sizing reaches 30% for moderate climate and at least 23% in other climates.

The table below shows the total steel weight of the structure (steel sheet weight included) needed for each climate.

Climate	Cold continental			Moderate			Mediterranean		
	PU	SW	PU/SW [%]	PU	SW	PU/SW [%]	PU	SW	PU/SW [%]
Roof insulation									
Steel [t]	171.9	184.9	93.0	126.5	141.2	89.6	126.5	141.2	89.6

Table 38: steel weight for each climate

Globally, an extra steel weight of about 10% is needed with SW insulation scenario.

C.1.5. Technical installations

The proposed HVAC installations are simple and well-adapted to commercial buildings:

- heating production with a gas condensing boiler;
- cooling production with a mono-bloc (no separated cooling tower) external chiller;
- heating and cooling distribution by 4-pipe fan coil;
- dedicated outdoor air system (DOAS) or air handling unit with plate heat recovery, heating and cooling coils and no possibility of humidification/dehumidification.

The capacity calculated for the installations (sensible load only) is presented here after.

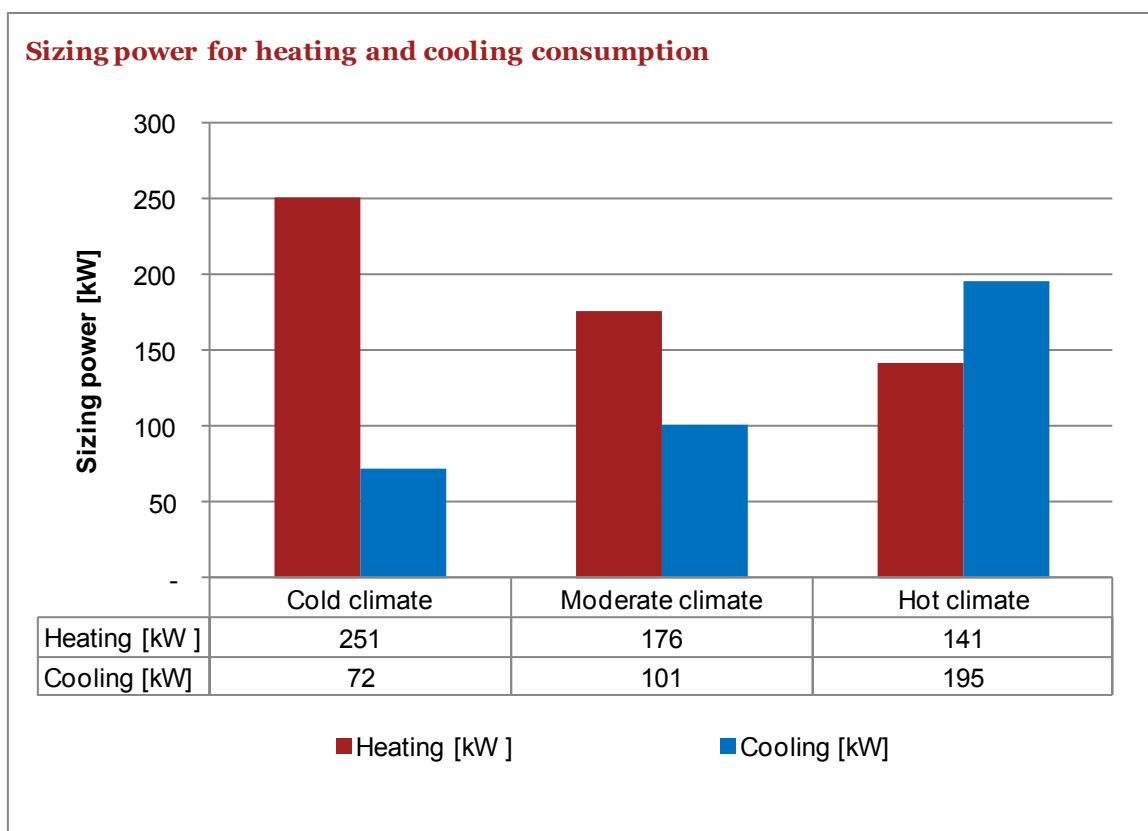

Figure 83 - Heating and cooling capacity

C.1.6. Thermal zones

The 5 thermal zones are presented in the table below. The assumptions are mainly based on DOE reference building.

Zone Name	Conditioned (Y/N)	Area (m ²)	Estimat. Volume (m ³)	People (m ² /per)	People	Lights (W/m ²)	Elec Plug and Process (W/m ²)	Ventilation (L/s/m ²)	Ventilation Total (L/s)	Ventilation Total (m ³ /h)	Infiltration (ACH)	Comments
Back_Space	Yes	380	2,317	55.74	6.82	4.31	4.04	0.75	284.92	1026	0.20	Only ventilation, no fan coils
Core_Retail	Yes	1600	9,763	12.39	129.20	9.15	1.61	1.50	2400.72	8643	0.20	
Point_of_Sale	Yes	151	920	12.39	12.17	9.15	10.76	1.50	226.22	814	0.20	
Front_Retail	Yes	151	920	12.39	12.17	9.15	1.61	1.50	226.22	814	0.20	
Front_Entry	Yes	12	73	12.39	0.97	5.92		1.50	18.00	65	0.20	
Total Conditioned Zones		2,294	13,993		161					11362		

Data Source 1 2 4 3 3 5

- Sources
- [1] 50 % of ASHRAE Standard 62.1-2004 Table 6-1, Atlanta, GA: American Society of Heating, Refrigerating and Air-Conditioning Engineers.
 - [2] 50% of ASHRAE Standard 90.1-2004 Tables 9.5.1 & 9.6.1, Atlanta, GA: American Society of Heating, Refrigerating and Air-Conditioning Engineers.
 - [3] ASHRAE Standard 62-1999 Table 6-1, Atlanta, GA: American Society of Heating, Refrigerating and Air-Conditioning Engineers.
 - [4] 50% of DOE Commercial Reference Buildings Report
 - [5] PwC proposition based on 5m³/h.m² for external wall in sandwich panels and 2 m³/h.m² for roof and slab

Table 39: thermal zone description for part A

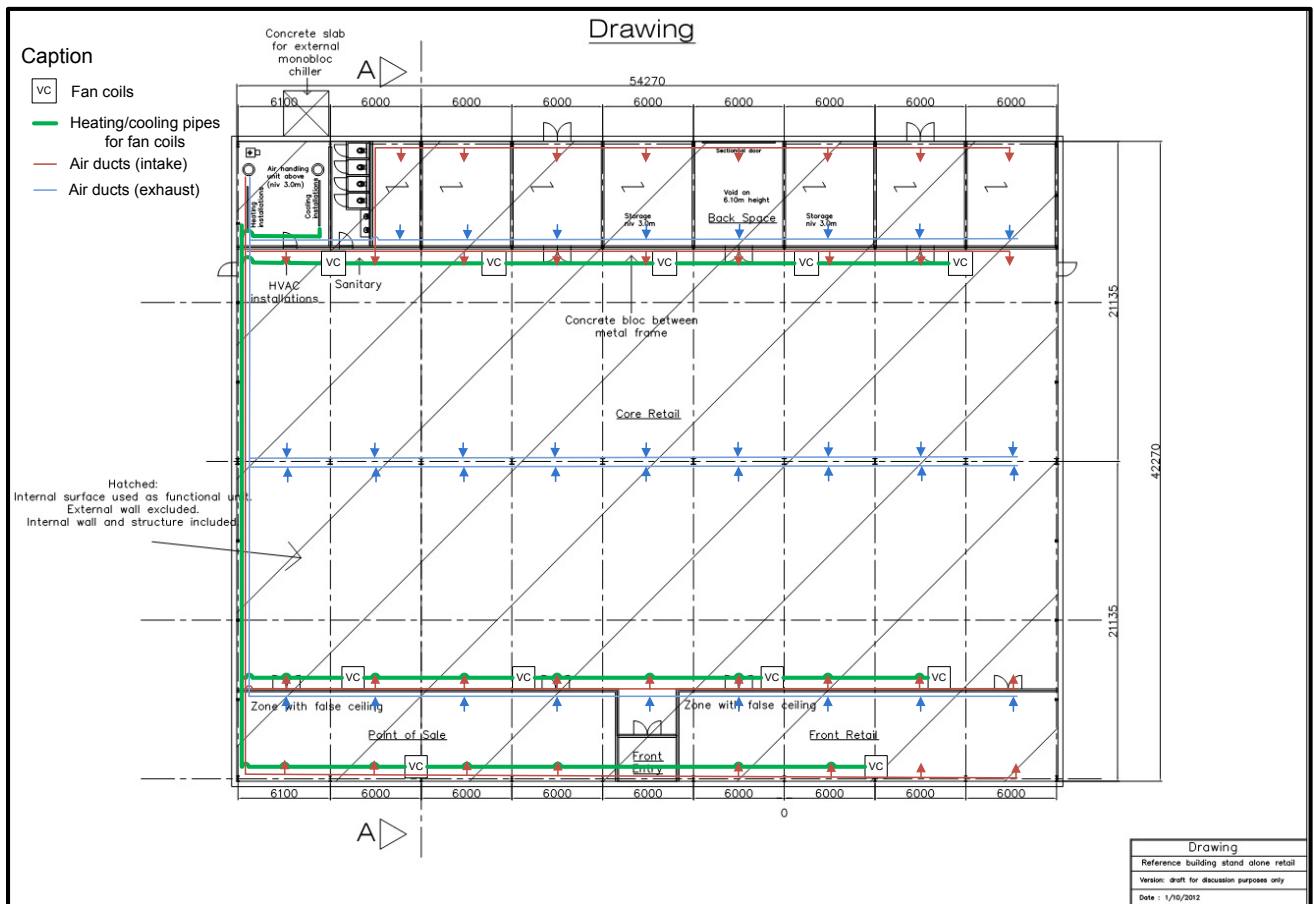

Figure 84 – Ventilation, heating and cooling distribution

C.1.7. Schedules

The occupation of the building is based on the following schedules types.

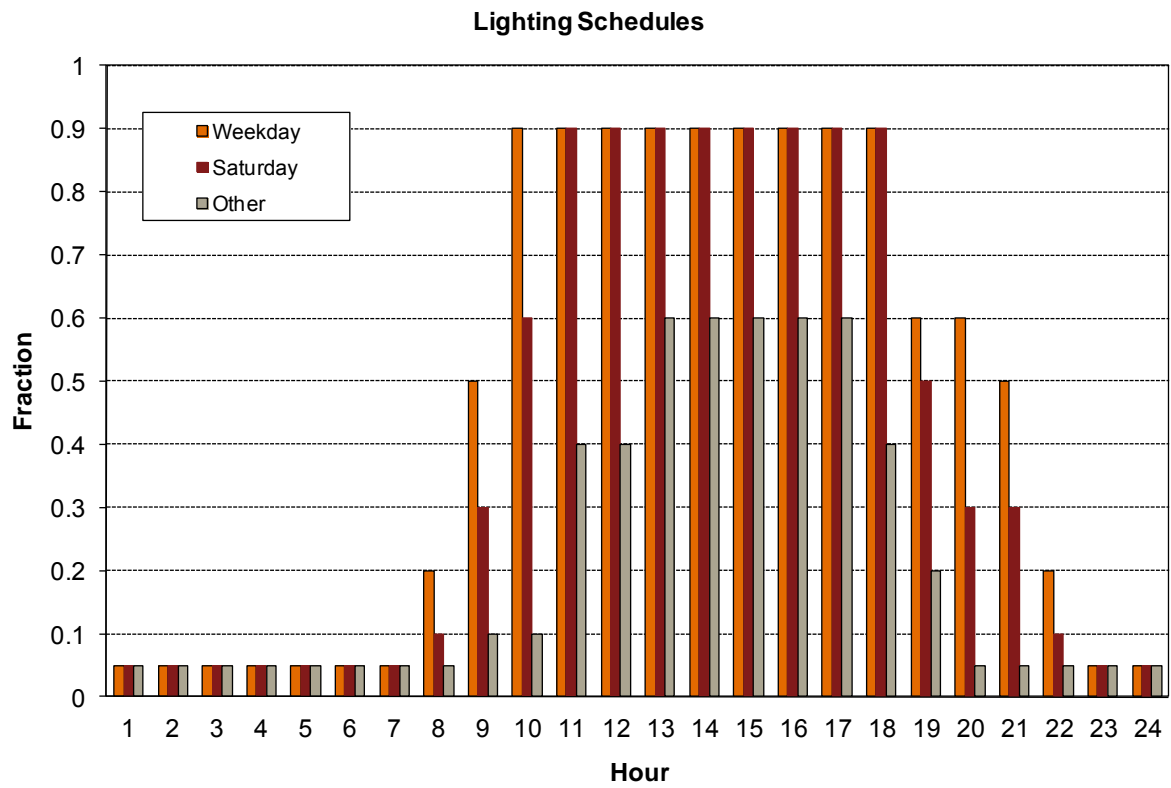

Figure 85: lighting schedules

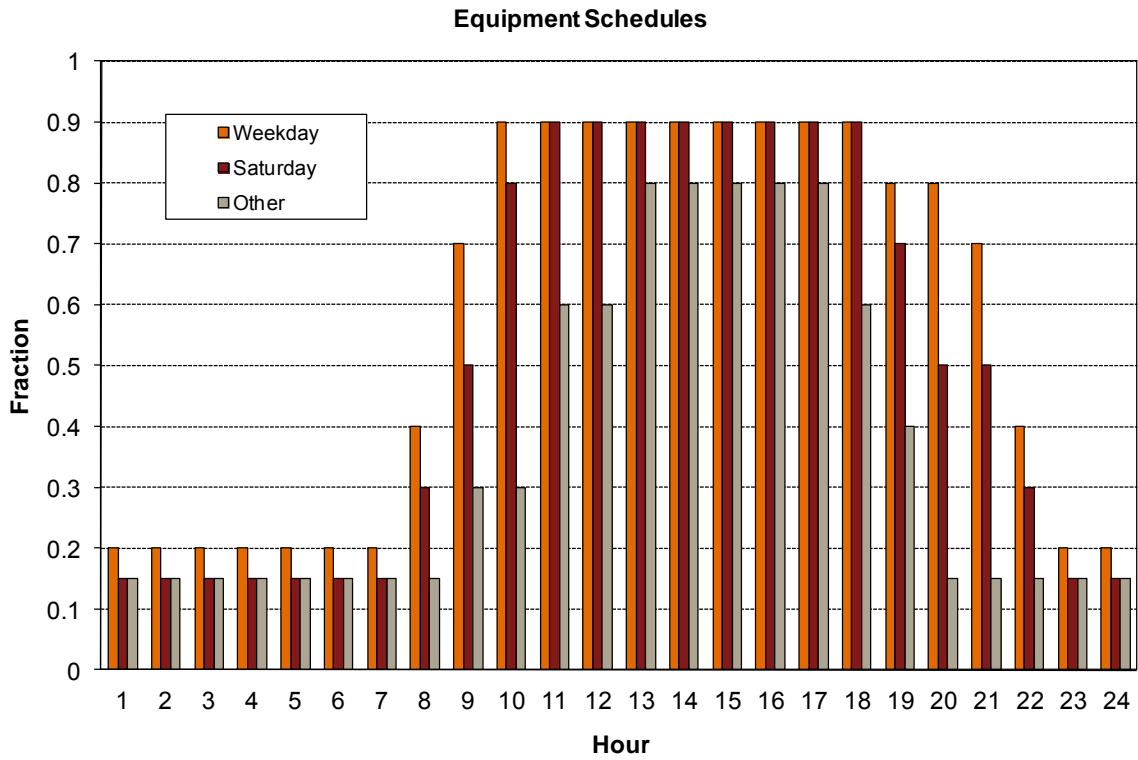

Figure 86: equipment schedules

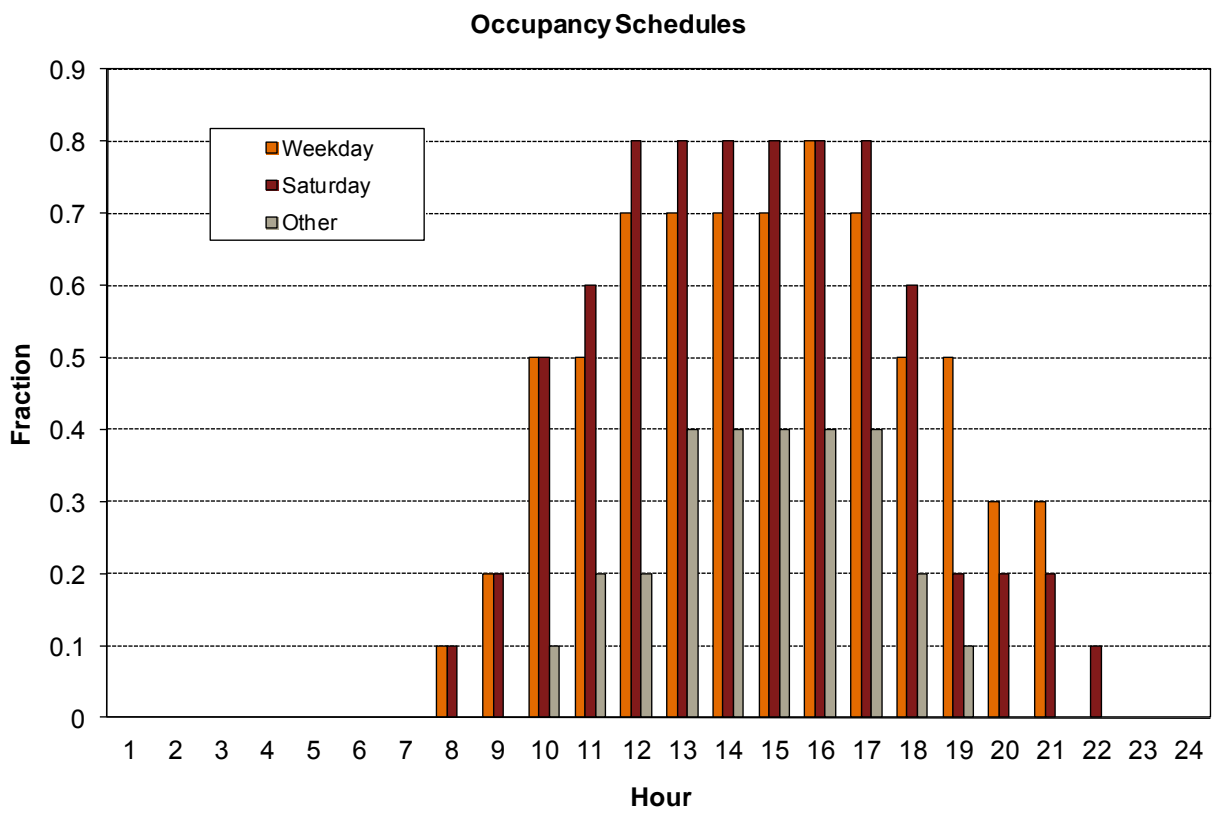

Figure 87: occupancy schedules

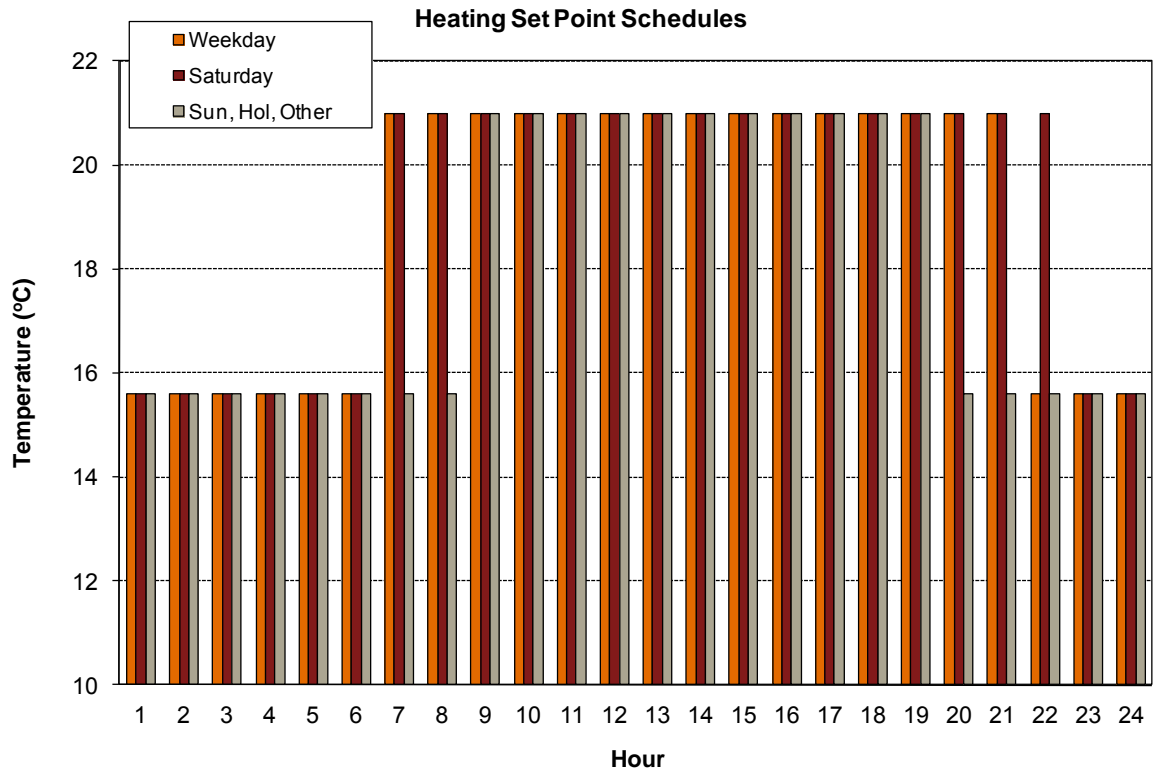

Figure 88: heating set point schedules

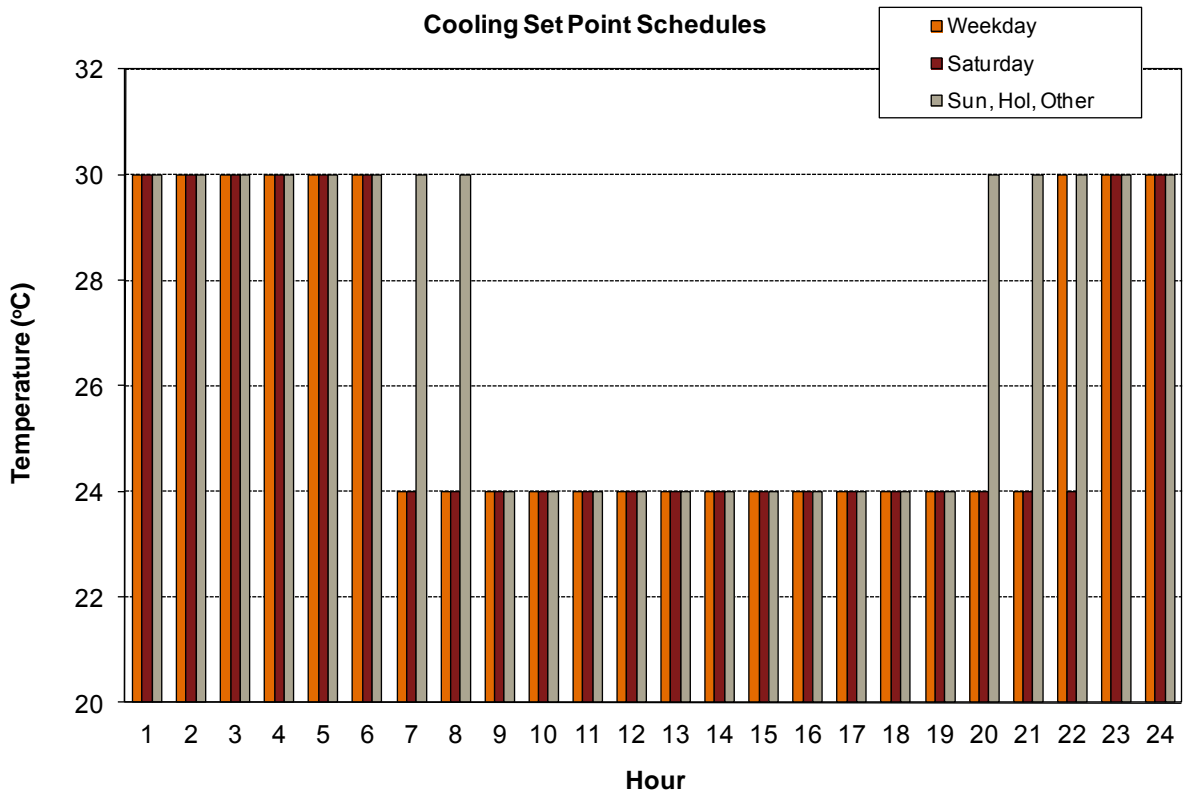

Figure 89: cooling set point schedules

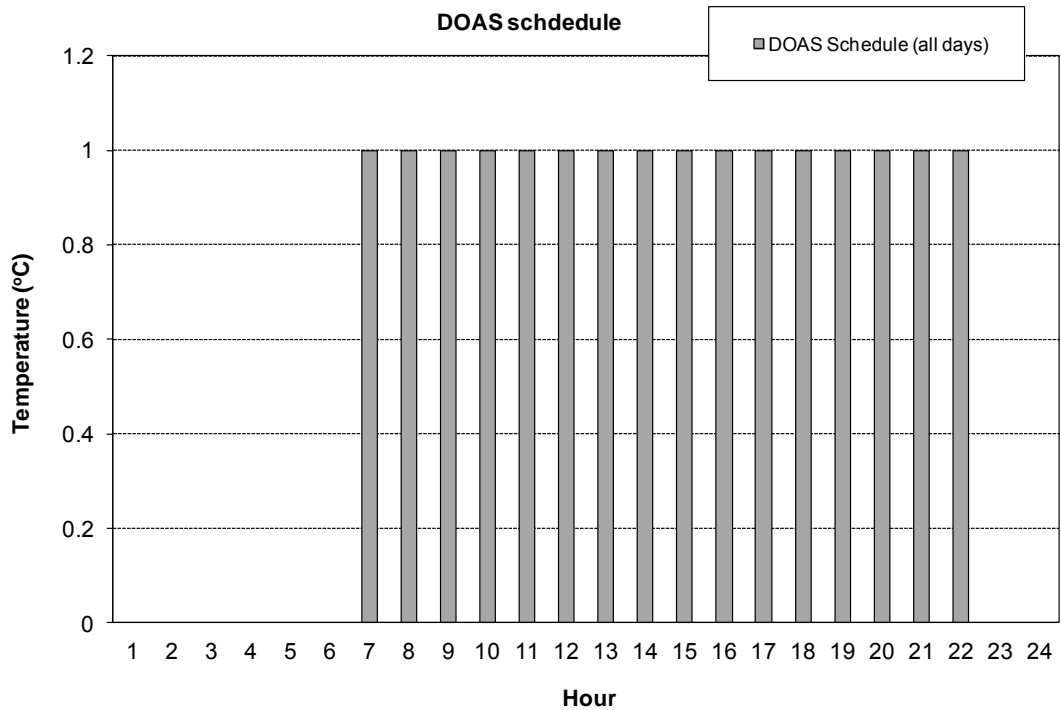

Figure 90 - DOAS Schedule

C.1.8. Ground temperature

The ground temperature in contact with concrete slab external face has to be modeled before thermal calculation. Energy + pre-processor (slab.exe) has been used to calculate the temperature under the slab. The results are presented on the graph below (average temperature for peripheral and central parts):

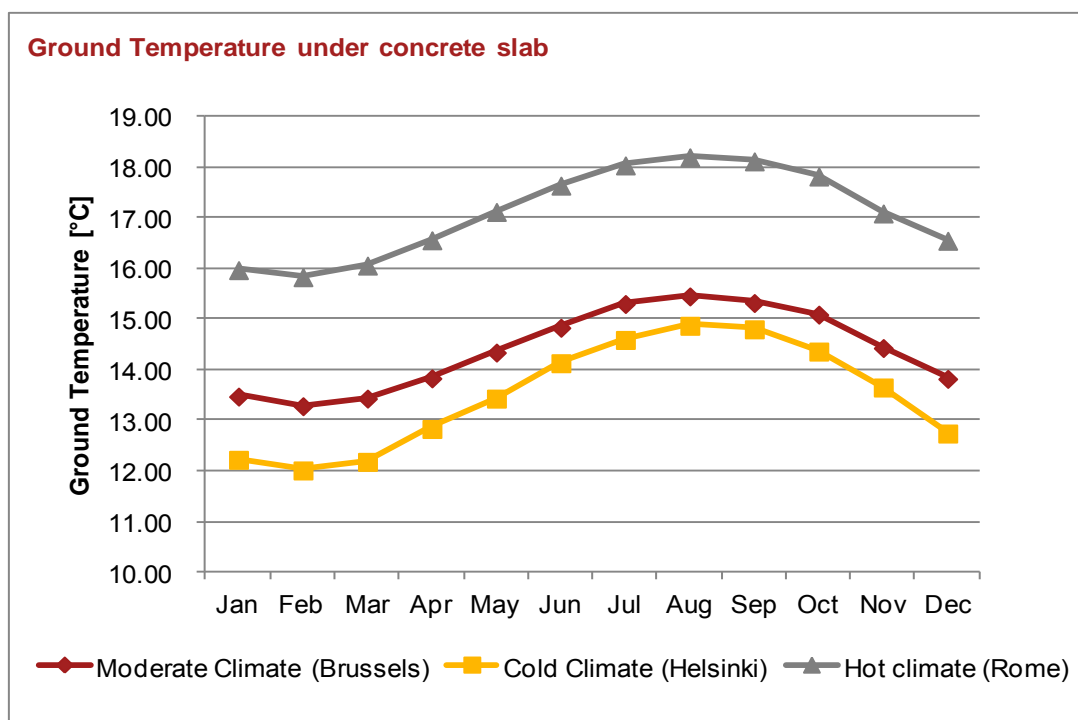

Figure 91: ground temperature

C.1.9. Thermal simulation results

C.1.9.1. Moderate Climate

C.1.9.1.1. Internal temperature

The mean air temperature in conditioned thermal zone follows heating and cooling set points during occupation. The graph below presents the situation for Core Retail Zone. Outside occupancy hours, the temperature set points are expanded (15°C for heating and 30°C for cooling) but are never reached. Indeed, the good insulation of the building limits temperature gaps between night and day.

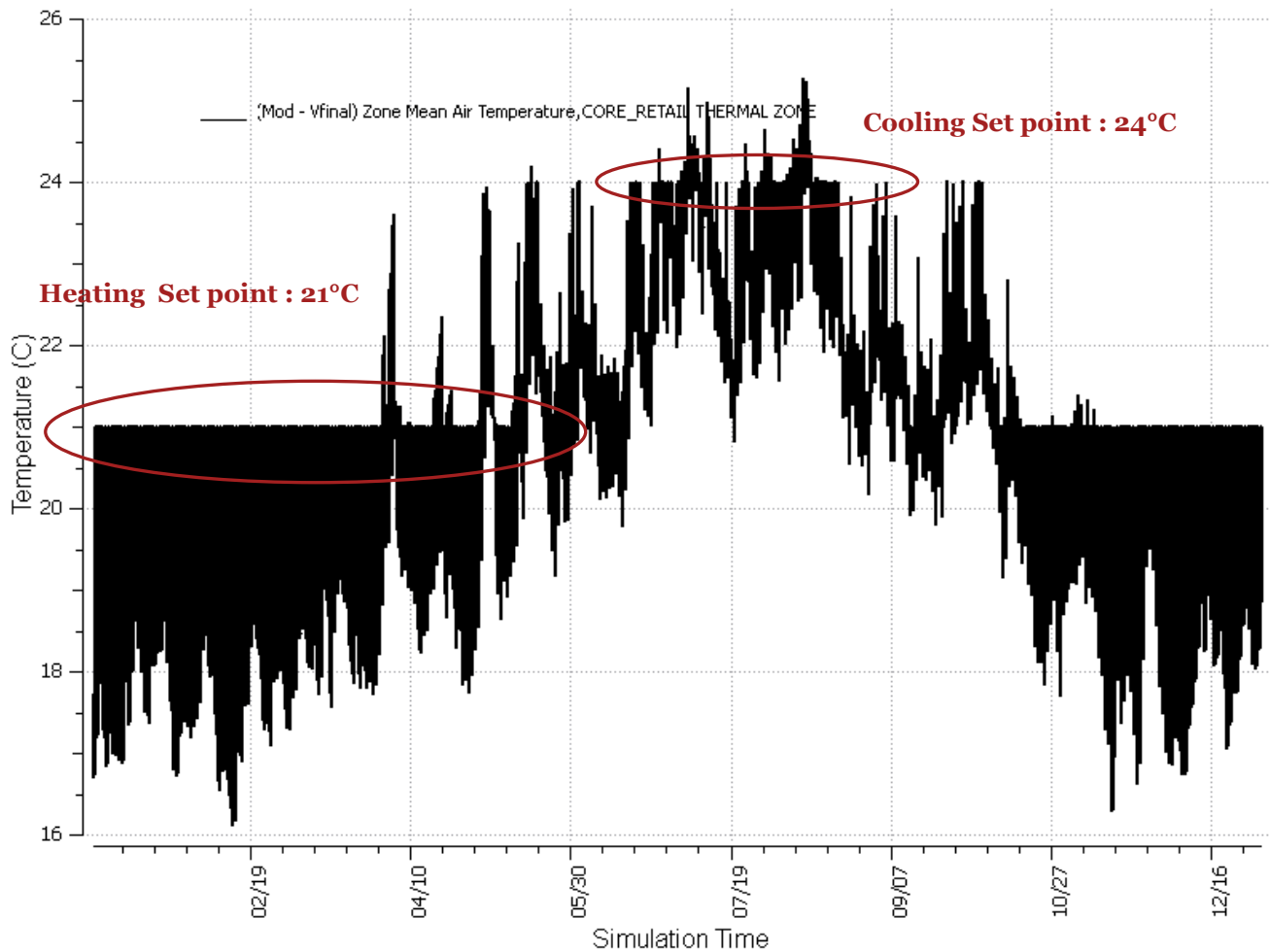

Figure 92- Core Retail - Mean air Temperature

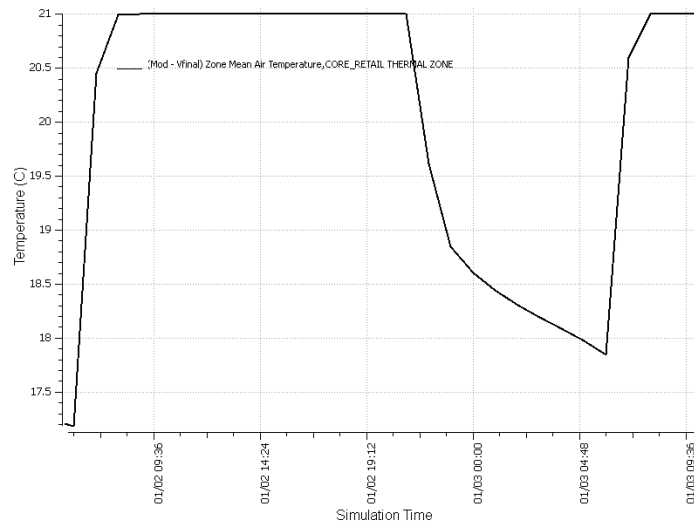

Figure 93- Core retail - Mean Air temperature on a winter day

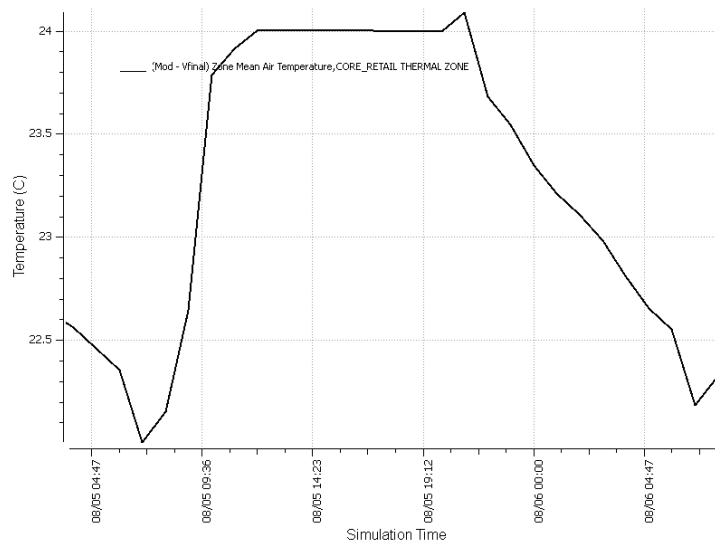

Figure 94 - Core retail mean air temperature - summer day

The back space of the building is ventilated only (through main Air Handling Unit) and no fan coils are present. The air passing through the AHU is pre-heated (20°C) and pre-cooled (25°C) and maintains a minimum temperature into the zone even if there is no climate control equipment. The minimum and maximum temperatures during a standard year are about 12°C and 27°C respectively.

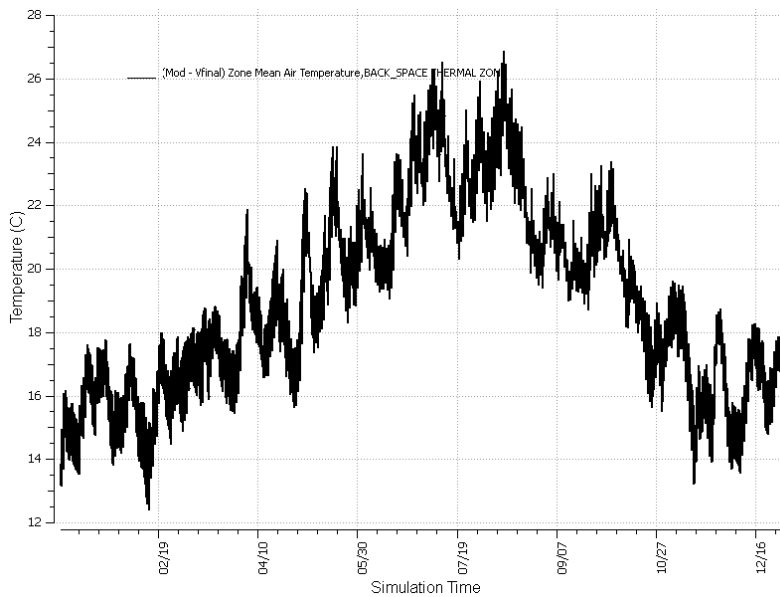

Figure 95- Back space -Mean air temperature

C.1.9.1.2. Energy consumption

C.1.9.1.2.1. Table summary

Moderate Climate	Electricity		Natural gas	
	[MWh]	[kWh/m ² .y]	[MWh]	[kWh/m ² .y]
Heating	0.0	0.0	84.3	36.8
Cooling	15.7	6.8	0.0	0.0
Interior Lighting	70.6	30.8	0.0	0.0
Exterior Lighting	0.0	0.0	0.0	0.0
Interior Equipment	27.9	12.1	0.0	0.0
Exterior Equipment	0.0	0.0	0.0	0.0
Fans	44.0	19.2	0.0	0.0
Pumps	3.2	1.4	0.0	0.0
Heat Rejection	0.0	0.0	0.0	0.0
Humidification	0.0	0.0	0.0	0.0
Heat Recovery	1.3	0.6	0.0	0.0
Water Systems	0.0	0.0	7.6	3.3
Refrigeration	0.0	0.0	0.0	0.0
Generators	0.0	0.0	0.0	0.0
-	0.0	0.0	0.0	0.0
Total End Uses	162.7	70.9	91.9	40.1

Figure 96 - Moderate climate energy consumption

C.1.9.1.2.2. Heating and cooling

The graph below presents building net heating and cooling consumptions for the moderate climate (Brussels) for a typical year. These results exclude production losses (for example the boiler efficiency).

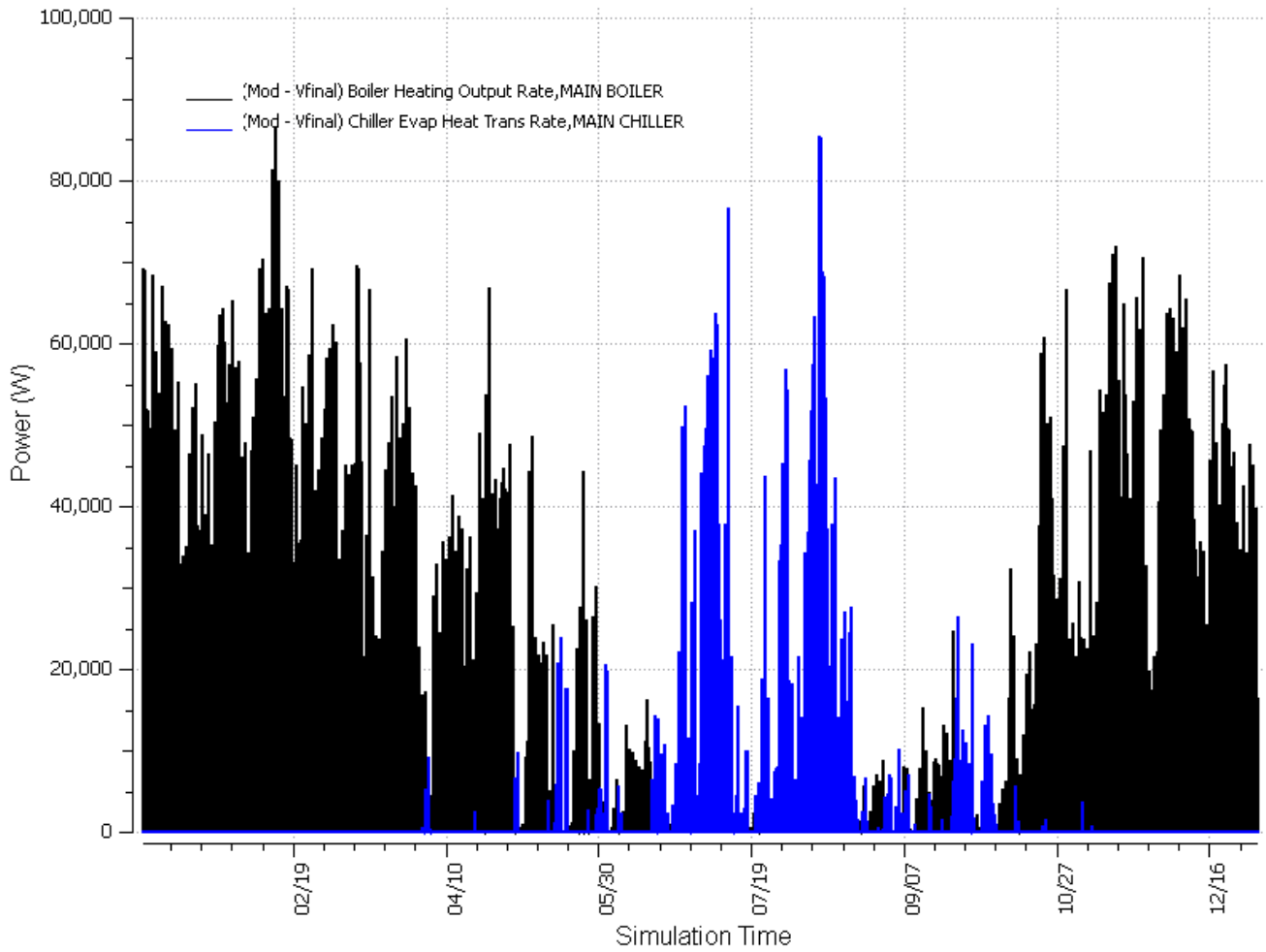

Figure 97 - Heating and cooling net consumptions

The Dedicated Outdoor Air System (DOAS) pre-heats the air before going through the ventilation system of the building. The graph below shows the ratio between DOAS heating coil and net total heating consumption (DHW excluded). The difference between the two (fan coils consumption) is prevailing.

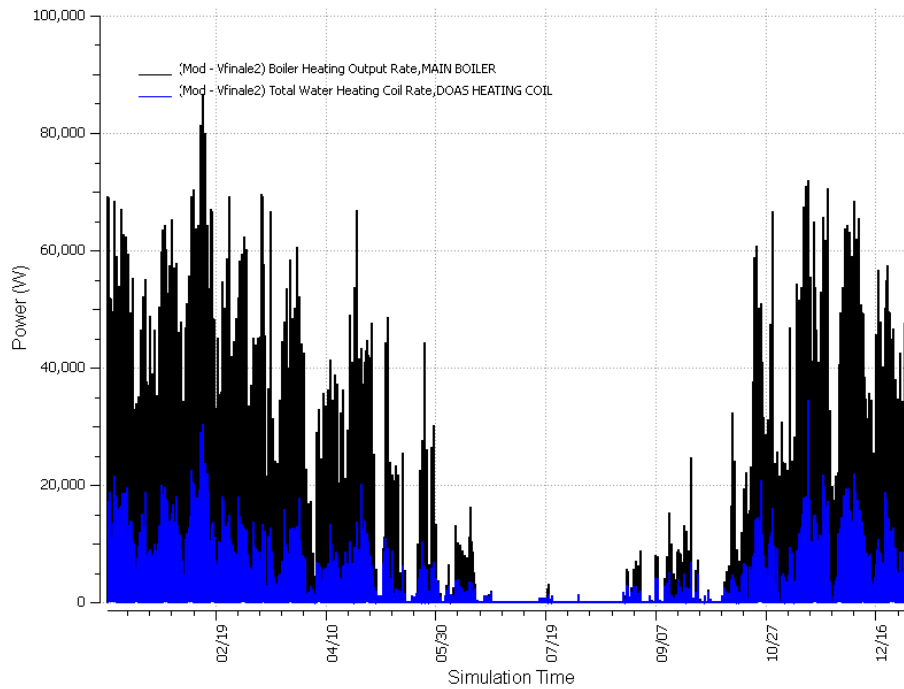

Figure 98 - Heating repartition

The same reasoning applies for cooling.

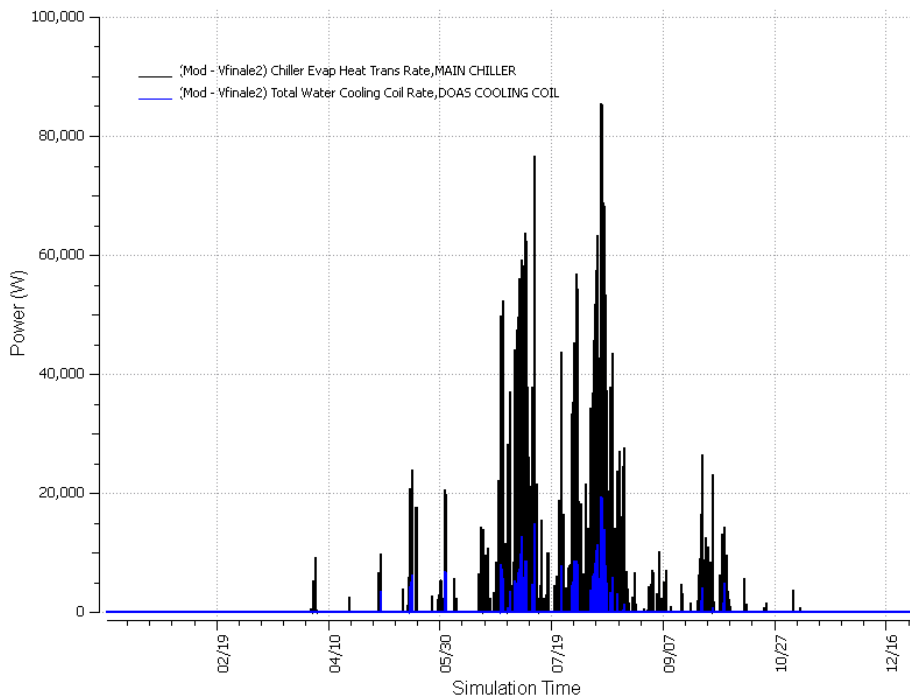

Figure 99 - Cooling repartition

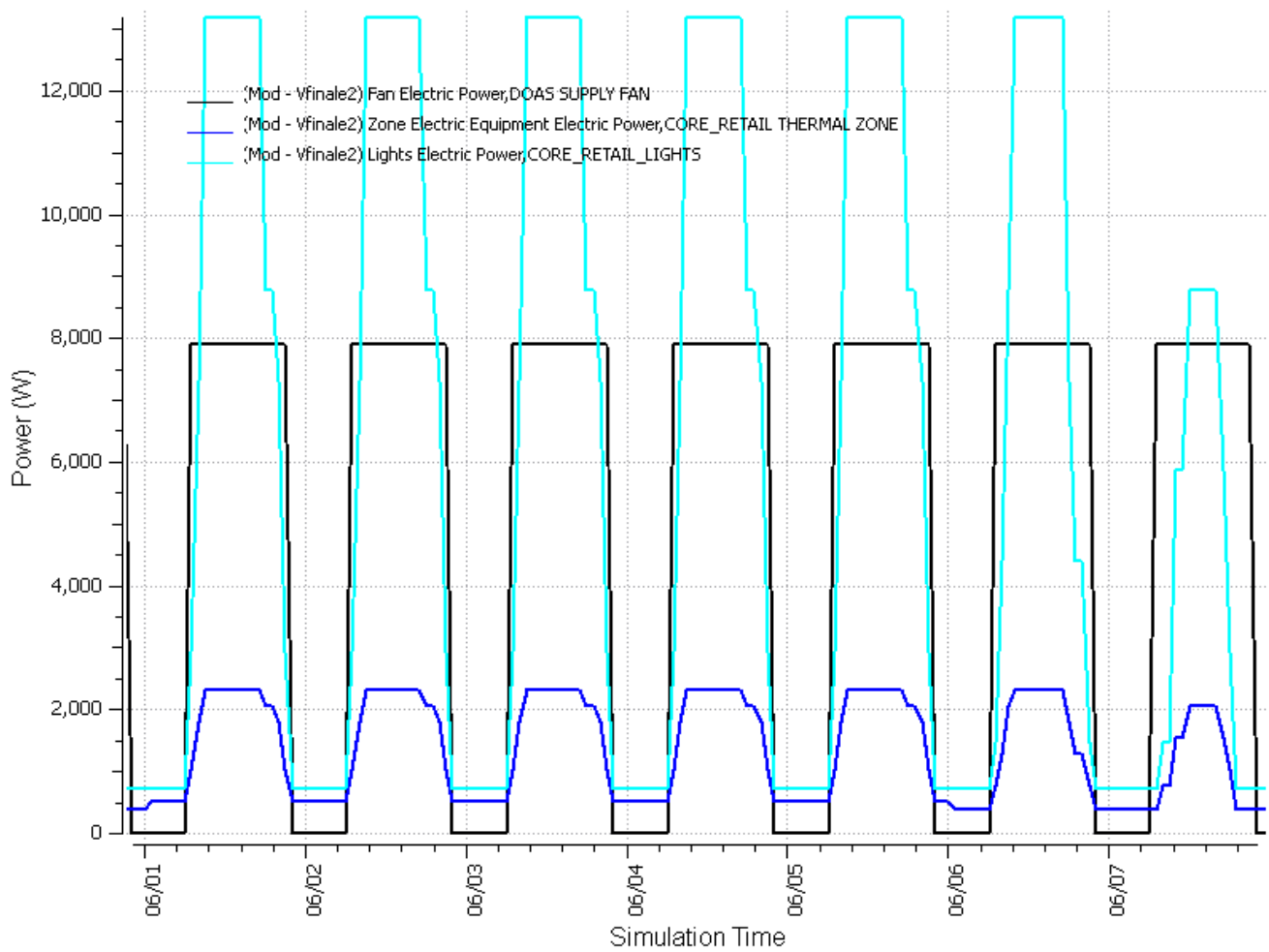

Figure 100 - Electric repartition on a standard week

The graph above presents electricity consumptions on a standard week for different services:

- air handling unit ;
- lighting in the core retail zone ;
- equipments in the core retail zone.

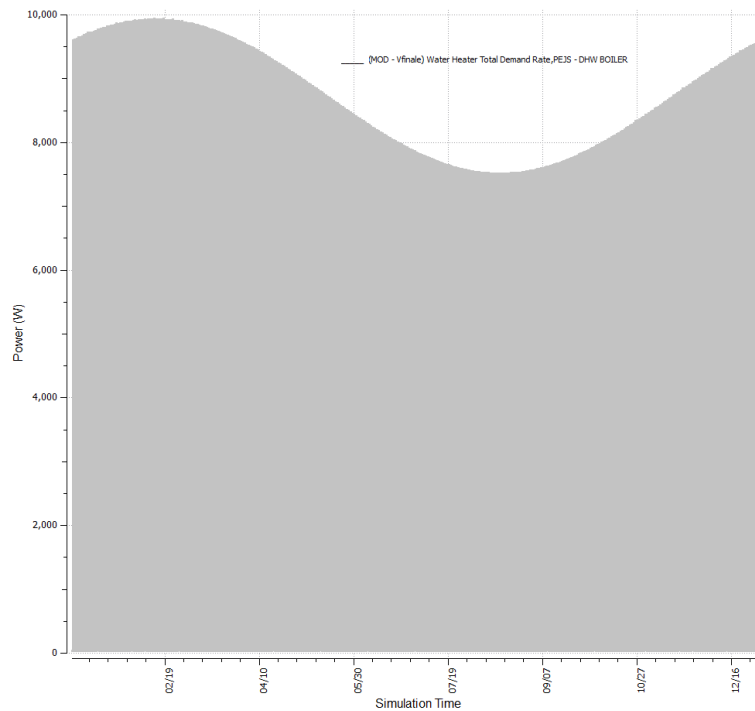

Figure 101 – Yearly domestic hot water power

The domestic hot water consumption on a yearly basis shows a slight reduction during summer because the boiler is situated in the non conditioned back space zone.

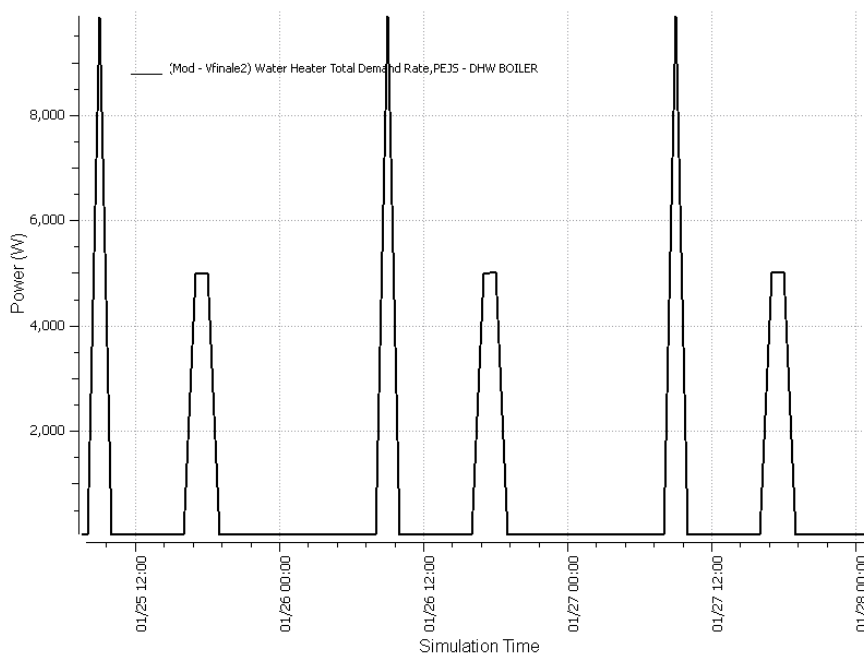

Figure 102 - Domestic hot water day

DHW consumption presents two consumption peaks on a typical day:

- one hour at maximum power in the morning (8h-9h)
- two hours at half power at the end of the afternoon (16h-18h).

C.1.9.1.3. Cold Climate

C.1.9.1.3.1. Assumptions

The main assumptions and results are similar for cold climate that for the moderate one. The modified elements are:

- the climate type and ground temperature ;
- the thermal performance of the envelope as described in section C.1.3 ;
- heating and cooling production equipments are auto-sized and are thus automatically adapted.

The energy consumption results are presented in the next section.

C.1.9.1.3.2. Table summary

COLD Climate	Electricity		Natural gaz	
	[MWh]	[kWh/m ² .y]	[MWh]	[kWh/m ² .y]
Heating	0.0	0.0	155.3	67.7
Cooling	12.2	5.3	0.0	0.0
Interior Lighting	70.6	30.8	0.0	0.0
Exterior Lighting	0.0	0.0	0.0	0.0
Interior Equipment	27.9	12.1	0.0	0.0
Exterior Equipment	0.0	0.0	0.0	0.0
Fans	44.1	19.2	0.0	0.0
Pumps	4.9	2.1	0.0	0.0
Heat Rejection	0.0	0.0	0.0	0.0
Humidification	0.0	0.0	0.0	0.0
Heat Recovery	1.3	0.6	0.0	0.0
Water Systems	0.0	0.0	7.6	3.3
Refrigeration	0.0	0.0	0.0	0.0
Generators	0.0	0.0	0.0	0.0
-	0.0	0.0	0.0	0.0
Total End Uses	160.9	70.1	162.9	71.0

Figure 103 - Cold climate energy consumption

C.1.9.1.4. Mediterranean Climate

C.1.9.1.4.1. Table summary

HOT Climate	Electricity		Natural gaz	
	[MWh]	[kWh/m ² .y]	[MWh]	[kWh/m ² .y]
Heating	0.0	0.0	29.2	12.7
Cooling	81.1	35.3	0.0	0.0
Interior Lighting	70.6	30.8	0.0	0.0
Exterior Lighting	0.0	0.0	0.0	0.0
Interior Equipment	27.9	12.1	0.0	0.0
Exterior Equipment	0.0	0.0	0.0	0.0
Fans	44.2	19.3	0.0	0.0
Pumps	4.6	2.0	0.0	0.0
Heat Rejection	0.0	0.0	0.0	0.0
Humidification	0.0	0.0	0.0	0.0
Heat Recovery	1.1	0.5	0.0	0.0
Water Systems	0.0	0.0	7.6	3.3
Refrigeration	0.0	0.0	0.0	0.0
Generators	0.0	0.0	0.0	0.0
-	0.0	0.0	0.0	0.0
Total End Uses	229.4	100.0	36.8	16.1

Figure 104 – Mediterranean climate energy consumption

C.2. Part

C.2.1. Building summary

The table below summarizes the main assumptions for the residential building model. More details are presented in the next section.

Part B		
Residential building		
Description	Value	Data Source
Building Summary		
Program		
Building Name	Reference Residential Building - Renovation	<i>BRE Report "Standard Dwellings"</i>
Available Fuel Types	Gas, electricity	<i>BRE Report "Standard Dwellings"</i>
Principal Building Activity	Residential	<i>BRE Report "Standard Dwellings"</i>
Form		
Total net floor area (including internal wall and structure)	128 m ²	<i>BRE Report "Standard Dwellings" + PwC modifications</i>
Building Shape	Rectangle	<i>BRE Report "Standard Dwellings"</i>
Aspect Ratio (width/depth)	1.3	<i>BRE Report "Standard Dwellings"</i>
Number of Floors	2 + attic	<i>BRE Report "Standard Dwellings"</i>
Window Fraction (Window to Wall Ratio)		
South	0.0198	<i>BRE Report "Standard Dwellings"</i>
East	0.1664	<i>BRE Report "Standard Dwellings"</i>
North	0	<i>BRE Report "Standard Dwellings"</i>
West	0.235	<i>BRE Report "Standard Dwellings"</i>
Total	0.094	<i>BRE Report "Standard Dwellings"</i>
Skylight/Tubular Daylighting Device Percentage	None	<i>BRE Report "Standard Dwellings"</i>
Shading Geometry	None	<i>BRE Report "Standard Dwellings"</i>
Azimuth	270	<i>PwC proposition</i>
Thermal Zoning	1 zone	<i>BRE Report "Standard Dwellings"</i>
Floor to Ceiling Height (m)	2.4	<i>BRE Report "Standard Dwellings"</i>
Roof type	Pitched roof to be renovated, 4 scenarios	<i>BRE Report "Standard Dwellings"</i>
Exterior walls		
Construction Type	Cavity walls, concrete slabs, pitched roof	<i>BRE Report "Standard Dwellings"</i>
Roof		
Construction Type	Pitched roof, 4 renovation scenarios	<i>BRE Report "Standard Dwellings"</i>
Window Dimensions (m²)		
South	0.95	<i>BRE Report "Standard Dwellings"</i>
East	3.30	<i>BRE Report "Standard Dwellings"</i>

North	0	BRE Report "Standard Dwellings"
West	8.91	BRE Report "Standard Dwellings"
Total Area (m2)	16.2	BRE Report "Standard Dwellings"
Operable area (m2)	0	BRE Report "Standard Dwellings"
Exterior walls		
Construction Type	Cavity walls, concrete slabs, pitched roof	BRE Report "Standard Dwellings"
Roof		
Construction Type	Pitched roof, 4 renovation scenarios	BRE Report "Standard Dwellings"
Window Dimensions (m2)		
South	0.95	BRE Report "Standard Dwellings"
East	6.30	BRE Report "Standard Dwellings"
North	0	BRE Report "Standard Dwellings"
West	8.91	BRE Report "Standard Dwellings"
Total Area (m2)	16.16	BRE Report "Standard Dwellings"
Operable area (m2)	0	BRE Report "Standard Dwellings"
Skylights/TDD		
Dimensions - Total Area (m2)	0	BRE Report "Standard Dwellings"
Operable area (m2)	0	BRE Report "Standard Dwellings"
Foundation		
Foundation Type	Reinforced concrete ground slab	BRE Report "Standard Dwellings"
Construction	Slab-on-ground	BRE Report "Standard Dwellings"
Internal dimensions - Total Area (m2)	52	BRE Report "Standard Dwellings"
Interior Partitions		
Construction	Concrete blocks + gypsum boards	PwC proposition
Internal Mass	13108.63	PwC proposition
Dimensions - Total Area (m2)	73.64	BRE Report "Standard Dwellings"
Air Barrier System	See plans	PwC proposition
Infiltration (ACH)	0.97	Based on an average pressure difference of 4 Pa
Infiltration q50 (m ³ /h.m ²)	4.2	Based on 5m ³ /h.m ² for existing parts and 2m ³ /h.m ² for renewed pitched roof
Thermal bridges		
T.B. heat loss compared to planned elements	≈ + 20%	PwC proposition
HVAC system		
Heating and cooling distribution system	2-pipe radiators	PwC proposition
Heating production	Traditional gas boiler	PwC proposition
Service Water Heating	3683 kWh/year	PwC proposition based on 25 litres DHW per occupant and per day.
SWH Type	Traditional gas boiler	PwC proposition
Hot water storage [litres]	160 litres	PwC proposition
Fuel	Gas	PwC proposition
Thermal Efficiency (%)	80%	PwC proposition
Temperature Setpoint (°C)	N/A	PwC proposition

Water Consumption (L)

DHW: 45,6 m³
Total fresh water consumption:
175 m³

*DHW: PwC proposition based on
25 litres DHW per occupant and per day
Cold Water: 35 m³/ person and year*

Table 40: building main characteristics

C.2.2. Building drawings

Based on the definition of the reference building and on the requirements of the study, drawings of the building are presented below and appended for better visibility.

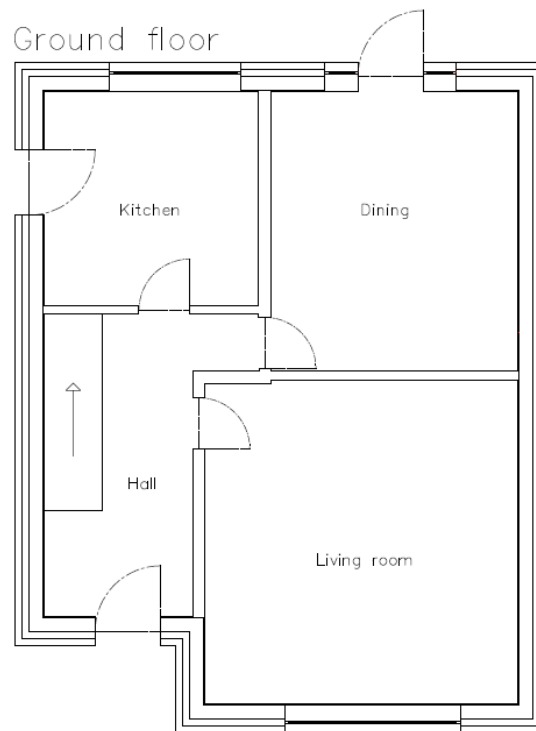

Figure 105: reference residential building ground floor

1st floor

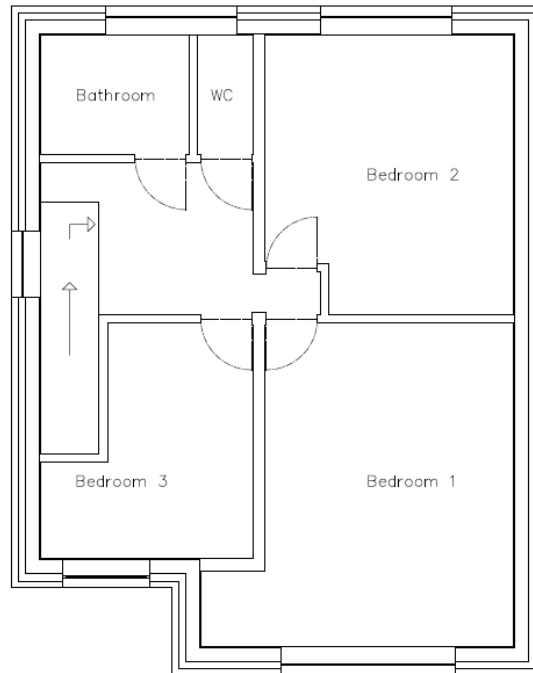

Figure 106: reference residential building 1st floor

Attic

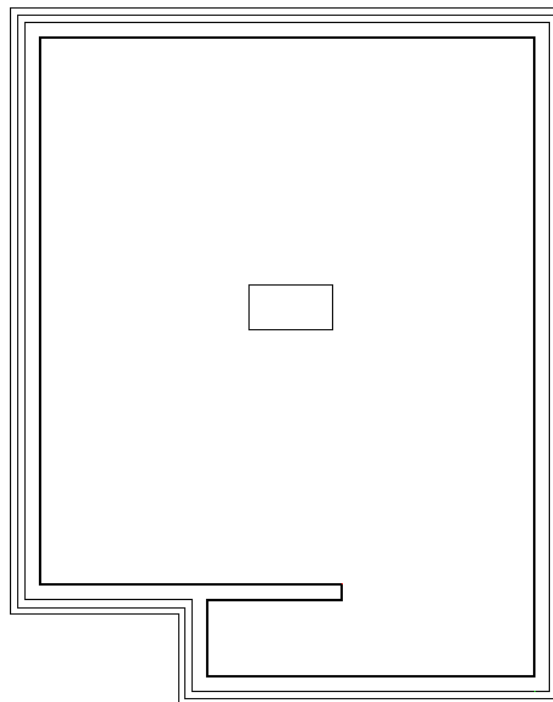

Figure 107: reference residential building attic

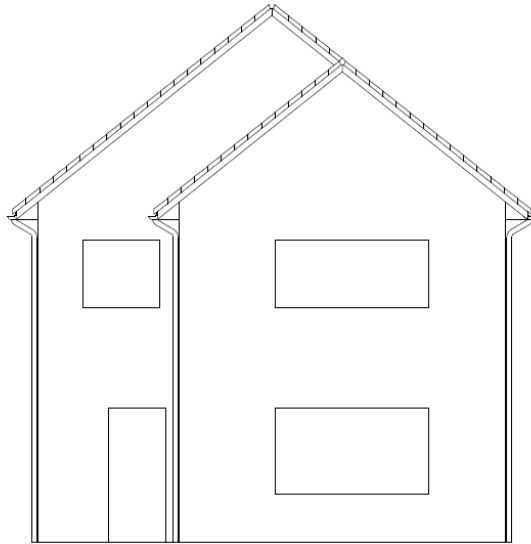

Figure 108: reference residential building front (East) façade

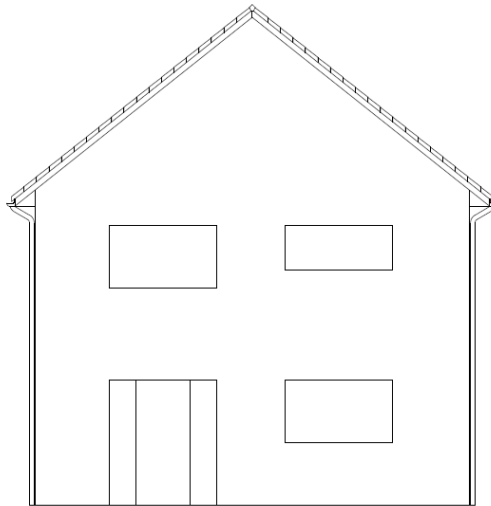

Figure 109: reference residential building back (West) façade

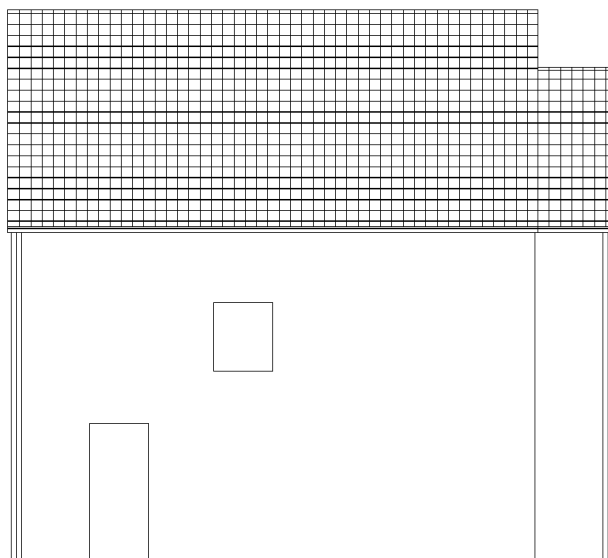

Figure 110: reference residential building South façade

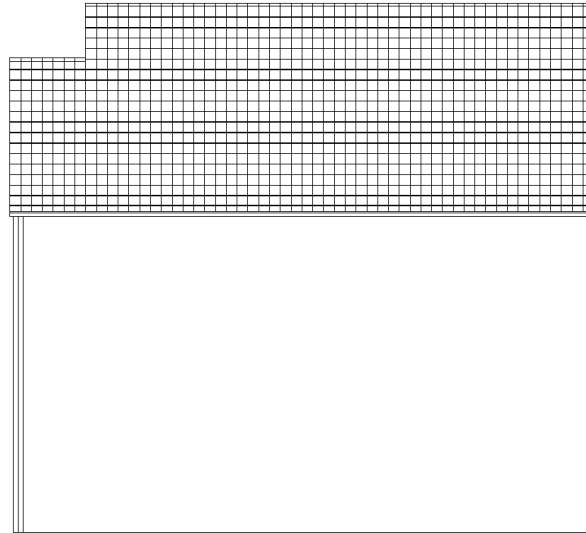

Figure 111: reference residential building North façade

C.2.3. Thermal envelope

	Components []	Density 1 [kg/m ³]	Lambda 1 [W/m.K]	Width 1 [m]	%	R Value [W/m ² .K]	U Value [W/m ² .K]
Cavity wall							
	Brick	1600	1.100	0.090	-	0.08	12.22
	Stone Wool	120	0.047	0.100	-	2.13	0.47
	Concrete block	1400	0.630	0.190	-	0.30	3.32
	Gypsum Board	1150	0.530	0.015	-	0.03	35.33
	Rint + Rext					0.17	
	Global					2.71	0.37
Door							
	Wood (oak)	800	0.130	0.040	-	0.31	3.25
	Rint + Rext					0.17	
	Global					0.48	2.09
Ground floor							
	Parquet	800	0.13	0.023	-	0.18	
	Reinforced concrete slab	2400	2.200	0.200	-	0.09	
	Reinforced concrete screed	1800	1.500	0.050	-	0.03	
	Rint + Rext					0.17	
	Global					0.47	2.12
Internal walls							
	Gypsum Board	1150	0.530	0.015	-	0.03	35.33
	Concrete block	1900	1.070	0.090	-	0.08	11.89
	Gypsum Board	1150	0.530	0.015	-	0.03	35.33
	Rint + Rext					0.26	
	Global					0.14	7.11
External roof s1 (PU on rafters)							
	Gypsum board		0.53	0.015	100%	0.03	
	Technical space		0.153	0.025	92%	0.15	
	Existing wood		0.120	0.025	8%	0.02	
	Existing SW between rafters	70	0.036	0.060	92%	1.53	
	Existing Rafters		0.120	0.100	8%	0.07	
	PU on rafters	32	0.023	0.100	100%	4.35	
	Rint + Rext					0.14	
	Global					6.28	0.16
External roof s2 (SW on and between rafters)							
	Gypsum board		0.53	0.015	100%	0.03	
	Technical space		0.153	0.025	92%	0.15	
	Existing wood		0.120	0.025	8%	0.02	
	New SW between existing rafters	70	0.036	0.100	92%	2.55	
	Existing Rafters		0.120	0.100	8%	0.07	
	New SW	165	0.040	0.135	100%	3.38	
	Rint + Rext					0.14	
	Global					6.33	0.16
External roof s3 (GW between and underneath rafters)							
	Gypsum board		0.53	0.015	100%	0.03	
	New GW with metal studs	28	0.032	0.100	100%	3.13	
	Existing Rafters		0.120	0.100	8%	0.07	
	New GW between existing rafters	28	0.032	0.100	92%	2.86	
	Rint + Rext					0.14	
	Global					6.23	0.16
External roof s4 (WF on and between rafters)							
	Gypsum board		0.53	0.015	100%	0.03	
	Technical space		0.153	0.025	92%	0.15	
	Existing wood		0.120	0.025	8%	0.02	
	New WF between existing rafters	55	0.038	0.100	92%	2.41	
	Existing Rafters		0.120	0.100	8%	0.07	
	New WF on rafters	140	0.042	0.125	100%	2.98	
	Natural water barrier	240	0.049	0.022	100%	0.45	
	Rint + Rext					0.14	
	Global					6.24	0.16

Table 41: thermal envelope for part B

Detailed drawings of the different refurbishment scenarios (s1 to s4) are appended for better visibility.

Remarks:

- The PU renovation scenario is the only one in which the existing insulation layer is not removed. To tackle the potential condensing issue due to the new vapor control sheet between the existing and new insulation layers, the empirical “+4 cm” has been applied. This means that new insulation layer (above rafters) is at least 4 cm thicker than the existing layer (between rafters). In our case, the existing SW layer is 6 cm thick, the new PU layer is thus 10 cm thick.
- The GW renovation scenario leads to a reduction of the available living area in the attic. If we consider the area where the clearance is 1m50 at least, the attic living area reduces from 27,9 m² to 25,1 m². However, this drawback cannot be taken into account in the LCC calculations and has thus to be kept in mind.
- Regarding U-values calculation, it is important to mention that:
 - the use of different insulation materials leads to slight differences in the real U-values of components. However, we will ignore the impact of these differences on the energy consumption;
 - all the possible U-value increases are included in thermal bridges estimation and not in the U-values above;
 - the U-value of the pitched roof is 0.16 W/m².K.

Windows

The proposed definitions of windows are listed below. The average data for U-values, SHGC (solar heat gain coefficient) and T.L (lighting transmittance) will be directly integrated into the thermal simulation model.

	Dimensions		Frame			Glass				WindowMaterial: SimpleGlazingSystem		
	Width [m]	Height [m]	Width [m]	Height [m]	U [W/m ² .K]	T.L [%]	SHGC [%]	U-Value [W/m ² .K]	T.L [%]	U Factor [W/m ² .K]	SHGC [%]	T.L [%]
Small windows	1.20	1.05	0.12	0.10	2.30	80.0%	75.5%	2.8	0.11	3.8	49%	52%
Big windows	2.40	1.05	0.12	0.10	2.30	80.0%	75.5%	2.8	0.11	3.1	55%	58%

Table 42: windows for part B

Thermal bridges

By assumption, about 20% additional losses have been added to take the thermal bridges into account. No thermal bridge has been added for ground slab due to lack of insulation in the building definition. Thermal bridges for external doors and windows are included in thermal wall U-value increases. The table below summarizes U-Values with thermal bridges included.

	Heat loss without T.B. [W/K]	T. B [W/K]	Total heat losses [W/K]	Surface [m ²]	Equivalent U Values [W/m ² .K]
Cavity wall	74.4	14.9	89.2	199.9	0.497
External Roof	13.0	2.6	15.6	82.1	0.190
Ground Floor	30.0	0	30.0	No Thermal Bridges	No Thermal Bridges
External windows and doors	50.1	10.0	60.1	Included in cavity walls	Included in cavity walls
TOTAL			195.0		

Table 43: thermal bridges parameters

Infiltrations

The infiltrations have been estimated thanks to Luxembourgish regulations. A value of $5\text{m}^3/\text{h.m}^2$ at 50 Pa has been chosen for the existing parts, falling to $2\text{m}^3/\text{h.m}^2$ at 50 Pa for the renovated pitched roof. A weighted average has been calculated based on these data. On this basis, the total infiltrations represent 0.97 ACH for each zone.

C.2.4. Technical installations

The technical installations proposed are typical for an existing dwelling:

- heating production with a traditional gas boiler;
- heating distribution by traditional radiators;
- centralized domestic hot water.

The dimensioning below has been based on Energy Plus dynamic thermal modeling. The values are logically based on the roof before refurbishment, and thus before complementary insulation. The thermal transmission coefficient for roof before refurbishment is 0,52 W/m².K.

With additional thermal bridges, U-value for the initial roof is 0,58 W/m².K

	Components []	Density 1 [kg/m ³]	Lambda 1 [W/m.K]	Width 1 [m]	%	R Value [W/m ² .K]	U Value [W/m ² .K]
Existing roof 6cm (Before refurbishment)	Gypsum board		0.53	0.015	100%	0.03	
	Technical space		0.153	0.025	92%	0.15	
	Existing wood		0.120	0.025	8%	0.02	
	Existing SW between rafters		0.036	0.060	92%	1.53	
	Existing Rafters		0.120	0.100	8%	0.07	
	Rint + Rext					0.14	
	Global					1.93	0.52

Table 44: roof initial U-value

The design was done with a large power reserve. This allows rapid temperature recovery after night reduction (theoretically 15 minutes). Large power reserves are indeed generally available for small heating installations where accurate sizing was not performed.

The sizing parameters are the following ones:

	Max.dry Bulb [°C]	Daily Temp. Range [delta C°]	Wind Speed [m/s]	Wind Direction
BRUSSELS - 12°C	-12	0	3.1	60

Table 45: sizing parameters

The winter set point schedule used for sizing is as follows:

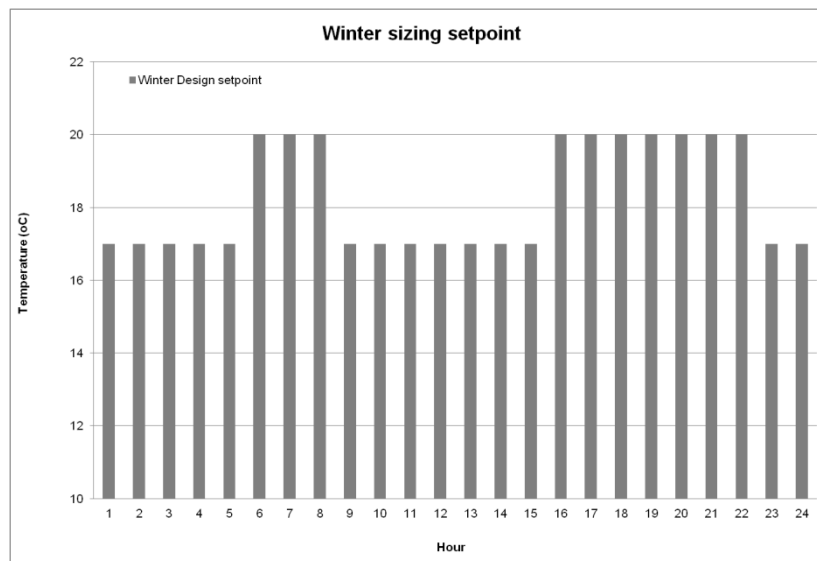

Figure 112: winter indoor temperature sizing set point

C.2.5. Thermal zones

The dwelling has been considered as three heated thermal zones.

C.2.6. Schedules

The following profiles were used in the thermal simulations.

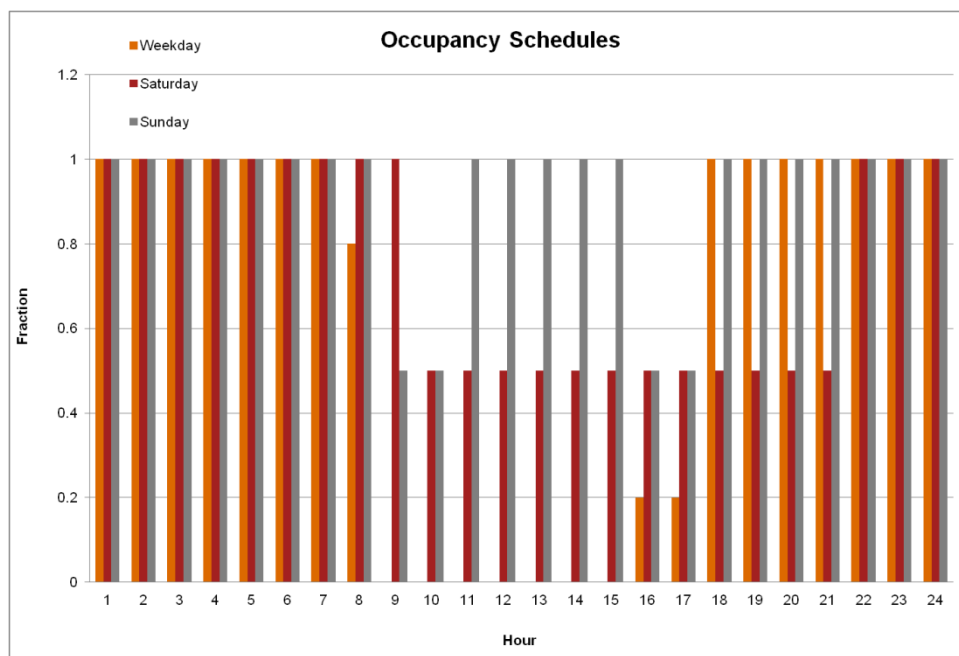

Figure 113: occupancy schedules

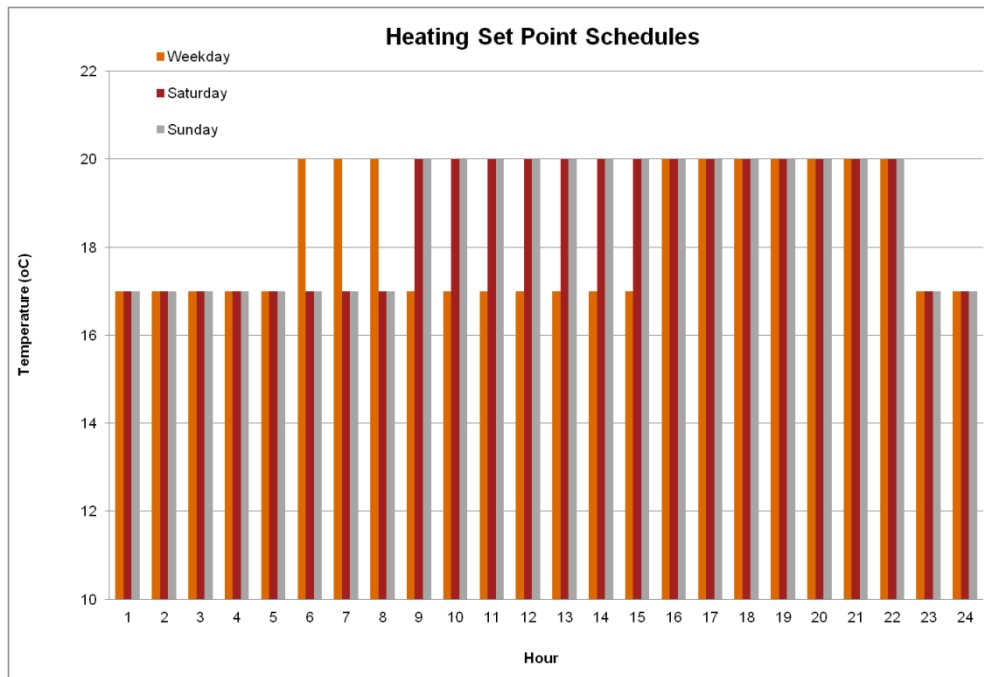

Figure 114: heating set point schedules

C.2.7. Ground temperature

The ground temperature has been calculated based on DIN EN ISO 13370. The calculated values for ground temperature on a monthly basis are presented in the graph below.

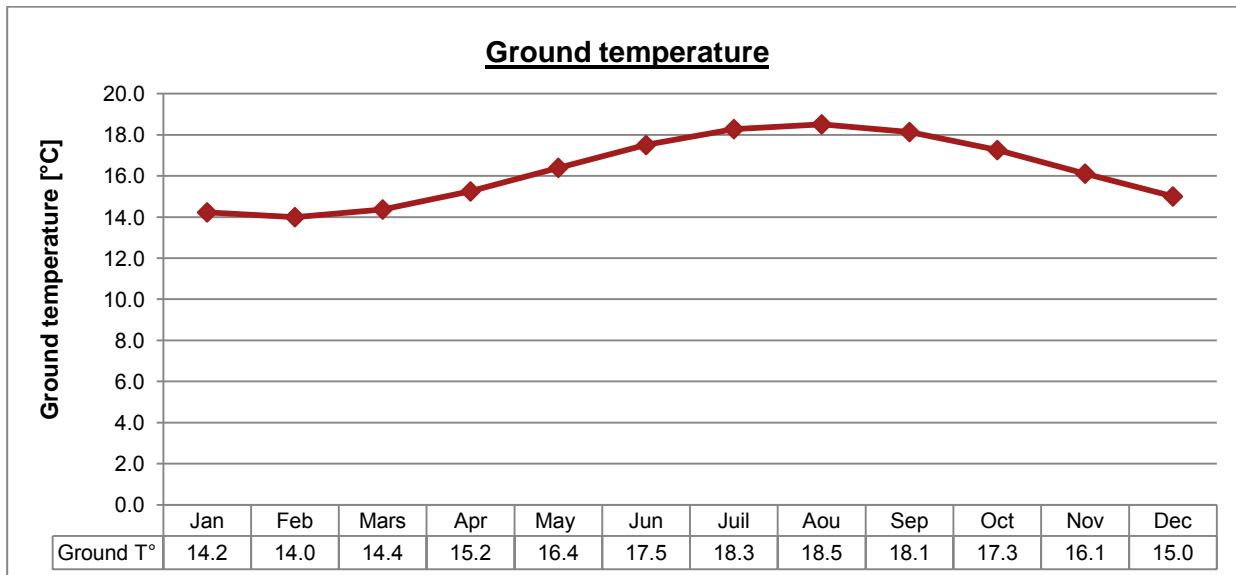

Figure 115: ground temperature

C.2.8. Thermal simulation results

C.2.8.1. Internal temperature

The graph below shows the temperature evolution in the dwelling for a typical year. During winter, the internal temperature is linked to the heating system. During this period, the temperature set points (20°C during occupation and 17°C during unoccupied periods) are met. In summer, no climate control device is active. As a result, the temperature fluctuates freely.

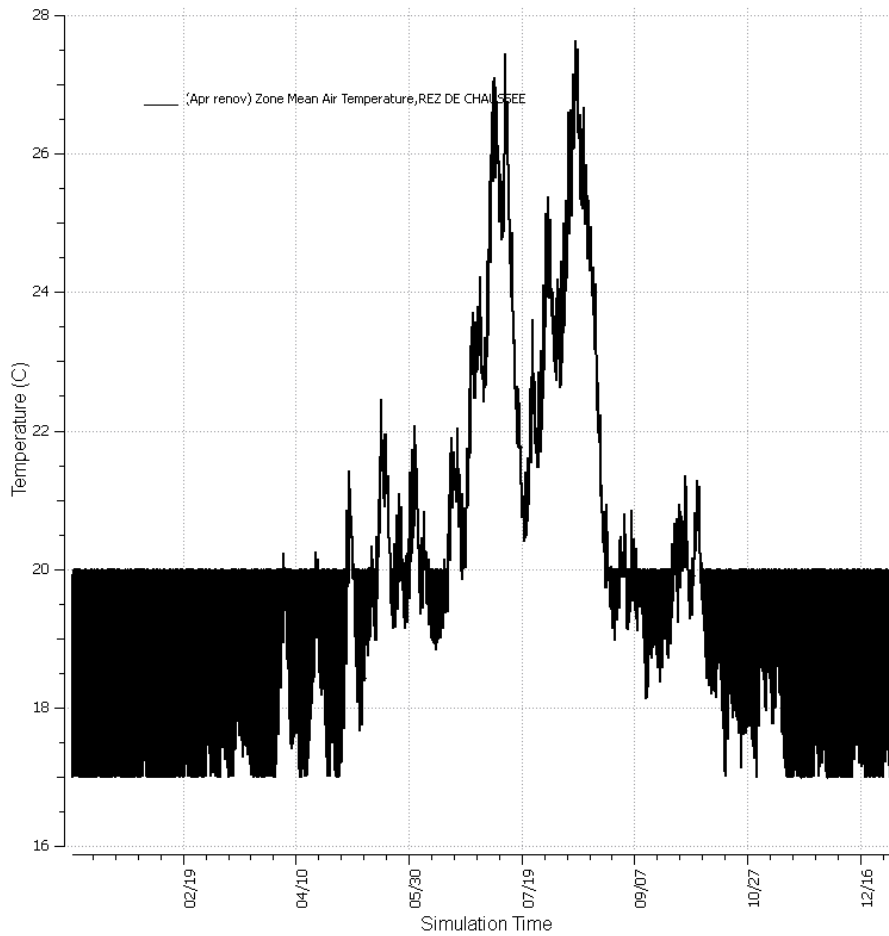

Figure 116 - mean air temperature

The temperature profile during a winter week shows temperature evolution between the set points.

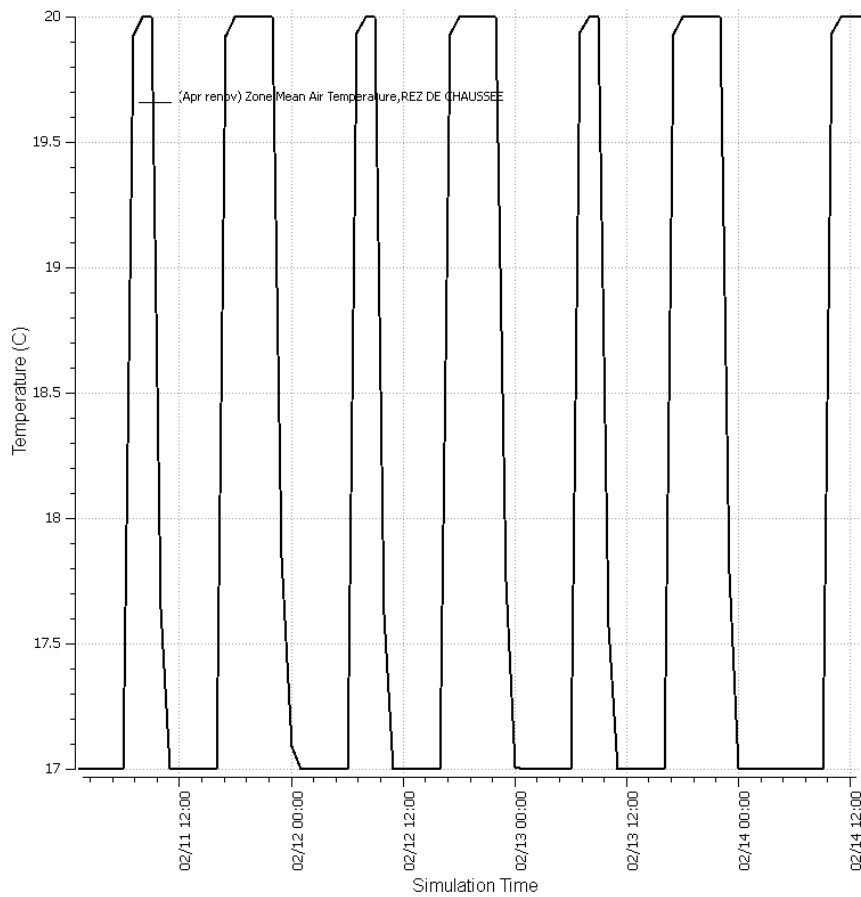

Figure 117 - mean air temperature

The attic is also heated. The mean air temperature profile in winter is similar to ground level.

In summer, the temperature reached in the attic is much lower after roof refurbishment. Thanks to the better insulation, the temperature difference between night and day periods is much lower as well. The graph below shows this fact on a typical summer week.

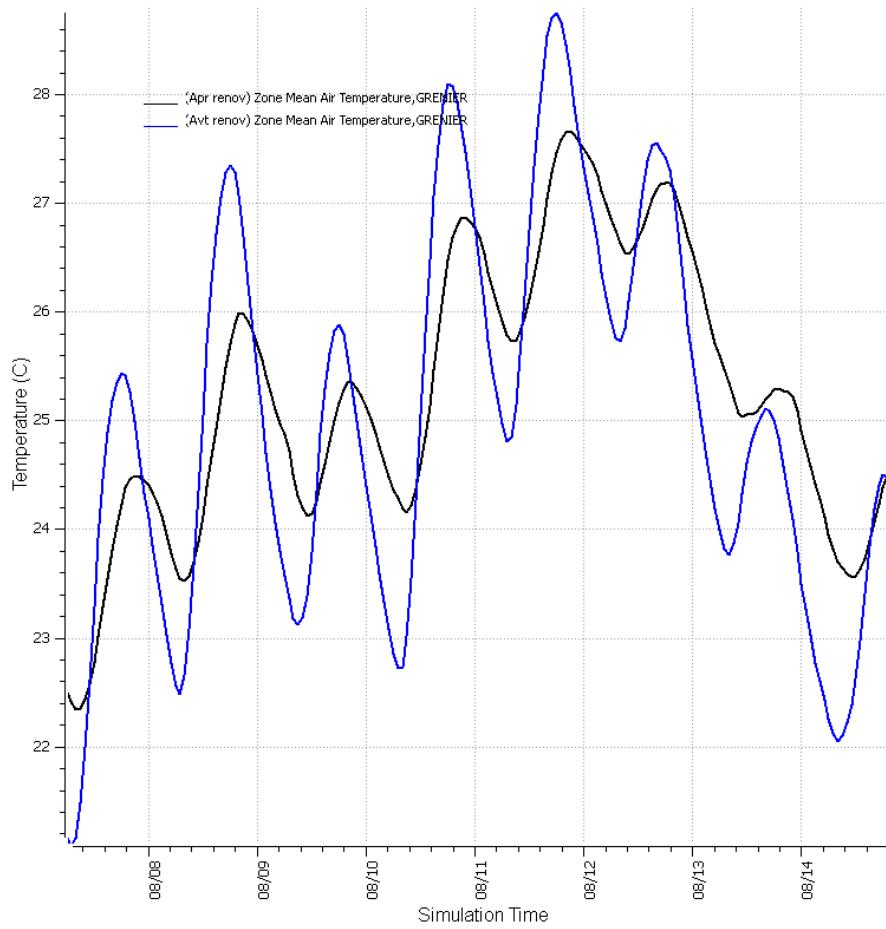

Figure 118 - temperature in attic for a summer week before and after refurbishment

C.2.8.2. Gas consumption

The table below shows monthly gas consumptions (domestic hot water excluded) before and after refurbishment.

Month	Monthly gas consumption (excluding DHW) BEFORE refurbishment [kWh]	Monthly gas consumption (excluding DHW) AFTER refurbishment [kWh]
Jan	4016	3529
Feb	3110	2691
Mar	2646	2299
Apr	1793	1553
May	533	416
Jun	280	217
Jul	30	11
Aug	152	110
Sep	602	501
Oct	1457	1239
Nov	2351	1997
Dec	3160	2732
SUM	20129	17295

Table 46: gas consumption before and after refurbishment

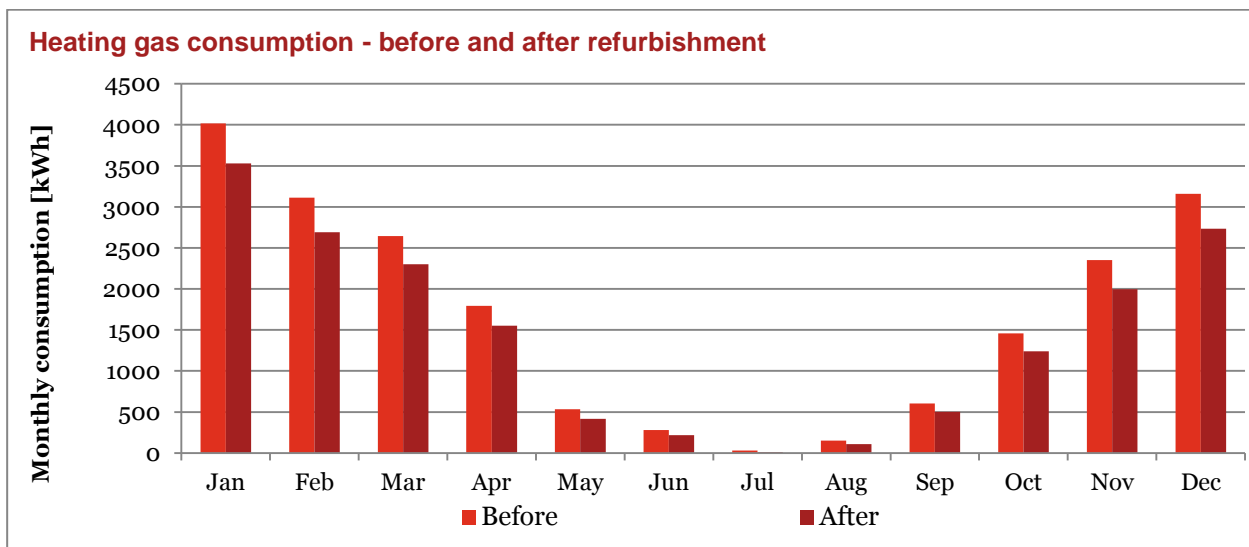

Figure 119 – gas consumption, before and after refurbishment

The pitched roof refurbishment leads to a decrease of 14% in energy consumption (DHW excluded). The reduction would have been more important without an existing insulation layer. The existing walls and slab are not well insulated and also lead to important heat loss. Moreover, heat losses through thermal conduction are not the only one: infiltrations and ventilation also cause heating needs.

Annual data	Annual gas consumption BEFORE refurbishment [kWh]		Annual gas consumption AFTER refurbishment [kWh]	
Heating	20128	100%	17294	86%
DHW	3683	100%	3683	100%
Total	23811	100%	20978	88%

Table 47 – gas consumption, before and after refurbishment

Appendix D. - *Bill of quantities*

PART A - Bill of quantities - Cold Climate - Wall PU / Roof PU
DIN 276-1 : 2008-12

Code	Designation	Building element	Quantity			Comment	Lifespan	Source		LCA source
			m2	m3	kg			Lifespan	LCC source	
300 Structure - construction works										
310 Excavation										
310		Excavation 80 cm	2370.00	1896.00			NA	Devis hall WAKO; Entreprise d		_Fouilles enlevées - Fiche ELODIE utilisateur
320 Foundations										
320		Bank - ballast 0/45 mm under floor slab (65 cm)	2246.60	1460.29	#####	Density: +/- 1800 kg/m3	100	Devis hall WAKO; Entreprise d econstruction ALLEVA		* Granulats - issus de roches massives (production) - Fiche ELODIE CSTB
320		Concrete foundation	123.40	86.38	207 312	Density: 2400 kg/m3 http://cat.inist.fr/?aModele=afficheN&cpsidt=17173	100	PwC hypothesis		Semelle filante 40x40 cm en béton armé C25/30 XF1 CEM II A - FDES plus disponible
320		PE film	2370.00	/	/		100	http://www.mesmatériaux.com/achat-matériaux/film-plastique-ep.200um-l.6m-x-l.25m-8978.html#ProdResume_A		_PE film (LDPE film, Europe) : production - Fiche ELODIE utilisateur
320		Geotextile	2370.00	/	/	Excluded in LCA model		http://www.mesmatériaux.com/achat-matériaux/feutre-geotextile-105g-m2-2x300m-gamme-s-bidim-8119.html#ProdResume_		0 - Pas de données environnementales associées
330 External walls										
331	Loadbearing external walls	Steel structure				23 463.2	>50	BBSR	Contact téléphonique Arcelor Mittal (0.7 EUT/kg) x2 pose comprise	Poutrelle en acier - FDES disponible sous INIES
332	Non-loadbearing external walls	NA	NA	NA	NA					
333	External columns	NA	NA	NA	NA					
334	External doors and windows	Front band of window with metal frame	76.00	/	/	Frames included in the dimensions Frame height: 10 cm Frame width: 12 cm Frame U value: 1.2 W/m2K (steel) Glazing U value (band of window): 0.77 W/m2K Glazing U value (window-door):0.76 W/m2K	40	BBSR	334.64 BKI	Fenêtre Aluminium Double vitrage - Fiche ELODIE CSTB
334		Window-door (front entry)	10.89	/	/		40	BBSR	334.24 BKI	Porte d'entrée vitrée en aluminium BEL'M - FDES disponible sous INIES
334		Insulated metal doors (6 doors)	15.23	/	/	Hormann MZ Thermo U = 1,2 W/m2.K	40	BBSR	334.14 BKI	Porte d'entrée non vitrée en acier BEL'M - FDES disponible sous INIES
334		Sectional door	26.40	/	/	http://www.hormann.be/index.php?id=4310&L=5	40	BBSR	334.14 BKI	_Industrial sectional doors with PU (polyurethane) foamed steel sections (company EPD) - Fiche ELODIE utilisateur
335	Cladding units	PU sandwich panel	976.81			12 356.6	>50	BBSR	Sandwich panels prices analysis	_PU foam core U 0.17 - Fiche ELODIE
335		Internal concrete blocks (9 cm)	146.28	13.17	25 013.5	Density: 1900 kg/m3	>50	BBSR	332.11 BKI	Mur en maçonnerie de blocs en béton - FDES disponible sous INIES
335		PU insulation (13.5 cm)	146.28	19.75	631.9	Density: 32 kg/m3 Lambda: 0.023W/m.K	>50	BBSR	Insulation price analysis	_PU thermal insulation board with aluminium facing with Credits (D) - Fiche ELODIE
335		External brick (9 cm)	162.53	14.63	23 404.5	Density: 1600 kg/m3 Lambda: 1.1 W/m.K http://www-energie2.arch.ucl.ac.be/transfert%20de%20chaleur/3.4.6.htm	>50	BBSR	332.16 BKI	Briques apparentes perforées - FDES disponible sous INIES

335	Concrete sill (9*25cm)	45.15	4.06	7 720.2	Density: 1900 kg/m3	>50	BBSR	332.11 BKI	Dalle de voirie en béton - FDES disponible sous INIES
335	Sandwich pannel bindings			14 438.4		>50	BBSR	Arcelor	Bardage acier simple peau - FDES disponible sous INIES
336	Internal linings (of external walls)	NA	NA	NA	NA				
337	Prefabricated façade units	NA	NA	NA	NA				
338	Solar protection	NA	NA	NA	NA				
339	External walls, other items	NA	NA	NA	NA				
340 Internal walls									
341	Loadbearing internal walls	Steel frame		8 753.5	Density: 7800 kg/m3	>50	BBSR	Arcelor	Poutrelle en acier - FDES disponible sous
341		Concrete blocks between metal frame - 20 cm	412.22	82.44	##### Density: 1900 kg/m3	>50	BBSR	342.10 BKI	Mur en maçonnerie de blocs en béton - FDES disponible sous INIES
342	Non-loadbearing internal walls	Concrete blocks - 14 cm	376.69	52.74	##### Density: 1900 kg/m3	>50	BBSR	342.10 BKI	Mur en maçonnerie de blocs en béton - FDES disponible sous INIES
343	Internal columns	NA	NA	NA	NA				
344	Internal doors and windows	Internal wood doors (10)	25.20	1.51	756.0 Density: 500kg/m3 http://www.allin.fr/index.php?option=com_content&view=article&id=75&Itemid=89#densité Thickness: 60 mm	>50	BBSR	344.12 BKI	* Porte Intérieure En Bois - Fiche ELODIE CSTB
345	Internal linings (of internal walls)	Plaster boards - 15 mm	1084.28	16.26	18 703.8 Densité: 1150 kg/m3 Lambda: 0.320 W/m.K	>50	BBSR	345.31 BKI	Plaque de plâtre KF BA15 - FDES disponible sous INIES
345		Stoneware wall tiles (WC)	42.24	0.42	1 013.8 Density: 2400 kg/m3 http://cat.inist.fr/?aModele=afficheN&cpsid=17173	>50	BBSR	345.53 BKI	Grès Cérame pleine masse (épaisseur moyenne 10 mm) - FDES disponible sous
346	Prefabricated wall units	NA	NA	NA	NA				
349	Internal walls, other items	NA	NA	NA	NA				
350 Floors and ceilings									
351	Floor structures	Reinforced concrete slab ground floor (25 cm)	2294	573.50	##### Densité béton: 2400 kg/m3 Lambda: 2.200 W/m.K	>50	BBSR	351.10 BKI	Béton armé pour Dalles et Prédalles pour utilisation en Maison Individuelle - Fiche ELODIE CSTB
351		Steel frame		5 754.0	Statics analysis assmption: 3.02 kN/m2	>50	BBSR	Arcelor	Poutrelle en acier - FDES disponible sous
351		Metal staircases (2)	2.00	st	Escaliers en acier pour atteindre chaque côté du niveau +1 du stock à partir de la zone de déchargement à l'arrière. Largeur: 1m, Hauteur: 3m	>50	BBSR	351.70 BKI	_Ossature acier galvanisé (QEB Logement) - Fiche ELODIE utilisateur
351		Hollow core slab - h=16 cm, 1st floor	286.44	/	88 180.3 Statics analysis assmption: 3.02 kN/m2	>50	BBSR	351.25 BKI	Plancher Seacbois sur poutrelle - FDES disponible sous INIES
352	Floorings	Concrete screed - 10 cm	2294.00	229.40	##### Densité béton: 1800 kg/m3 Lambda: 1.500 W/m.K	>50	BBSR	352.21 BKI	Chape fluide béton autoplaçante C25 XF1 (liant ciment) épaisseur 5 cm - FDES disponible sous INIES
352		PU insulation - 120 mm	2294.00	275.28	8 809.0 Density: 32 kg/m3	>50	BBSR	Insulation price analysis	_PU thermal insulation board with aluminium facing - Fiche ELODIE utilisateur
352		Stoneware floor tiles (all surfaces exsept technical and storage rooms)	1913.27	19.13	45 918.5 Density: 2400 kg/m3 http://cat.inist.fr/?aModele=afficheN&cpsid=1717373	>50	BBSR	352.31 BKI	Grès Cérame pleine masse (épaisseur moyenne 10 mm) - FDES disponible sous INIES
352		Compression slab - 5 cm	286.44	14.32	36 498.5 Statics analysis assmption: 1.25 kN/m2	>50	BBSR	352.21 BKI	Semelle filante 40x40 cm en béton armé C25/30 XF1 CEM II A - FDES plus disponible
352		Concrete screed - 5 cm	286.44	14.32	29 198.8 Statics analysis assmption: 1 kN/m2	>50	BBSR	Included in compression slab cost (in LCC: 20% considered for concrete screed)	Chape fluide béton autoplaçante C25 XF1 (liant ciment) épaisseur 5 cm - FDES disponible sous INIES
353	Ceiling linings	Ceiling linings	299.44	1 197.8	Fond-plafond minéral, 4kg/m2	>50	BBSR	353.87 BKI	Panneau de laine de roche EQUATION 20 mm - FDES disponible sous INIES

353	Metal studs for ceiling linings	299.44		595.6	Fixation 0.51 kg/ml, 3.9ml/m2	>50	BBSR	Included in ceiling linings cost (in LCC: 20% considered for metal studs)	_Ossature acier galvanisé (QEB Logement) - Fiche ELODIE utilisateur		
359	Floors and ceilings, other items	NA	NA	NA							
360 Roofs											
361	Roof structure	Steel frame		91 592.6	Density: 7800 kg/m3	>50	BBSR	Arcelor	Poutrelle en acier - FDES disponible sous		
362	Roof lights, roof openings	NA	NA	NA							
363	Roof coverings	Waterproofing membrane (bitumen)	2434.78	/	15 217.4	>50	BBSR	363.11 BKI +/-26€/m2 p. 74, 168, 189	Membrane d'étanchéité synthétique fixée mécaniquement - FDES disponible sous		
363		PU insulation - 330 mm	2310.82	762.57	24 402.2	>50	BBSR	Insulation price analysis	_PU thermal insulation board with aluminium facing with Credits (D) - Fiche ELODIE		
363		Vapour-barrier	2310.82	/	/	>50	BBSR	Source: idem que part B	_polypropylene (PP, Europe, 2005): Production - Fiche ELODIE utilisateur		
363		Roofing sheet trapezoidal	2263.06		27 925.4	>50	BBSR	Arcelor	Bardage acier simple peau - FDES disponible sous INIES		
364	Roof linings	NA	NA	NA							
369	Roofs, other items	Rainwater gutter	162.81	mct		>50	BBSR	369.12 BKI	_zinc : production - Fiche ELODIE utilisateur		
369		Rainwater pipes (8)	51.2	mct		>50	BBSR	369.11 BKI	_zinc : production - Fiche ELODIE utilisateur		
370 Structural fitments											
390 Other construction-related activities											
400 Structure - services											
411	Sewerage systems	PVC DN 50 pipes	/	/	/	5.5	Source: http://www.walraven.com/library/documents/fr/Pipe-Dimensions-and-Weights-data-sheet-FR.pdf	>50	DGNB 410	http://www.mesmatériaux.com/achat-matériaux/tube-pvc-nf-o50mm-l4m_1770.html	Canalisations PVC destinées à la collecte et à l'évacuation des eaux usées et des eaux vannes d'une maison individuelle - FDES disponible sous INIES
411		PVC DN 110 pipes	50	mct	130.5			>50	DGNB 410	http://www.mesmatériaux.com/achat-matériaux/tube-pvc-nf-o110mm-l4m_1761.html	Canalisations PVC destinées à la collecte et à l'évacuation des eaux usées et des eaux vannes d'une maison individuelle - FDES disponible sous INIES
412	Water supply systems	Ceramic toilet bowl (4)	4	/	100.0	http://www.duravit.fr/website/homepage_fr/produits/nouveaux_produits/s%C3%A9ries/duraplus.fr-fr.html/p-92021	>50	DGNB 410	412.65 BKI	Pack WC (cuvette et réservoir) en porcelaine avec son mécanisme et son abattant - FDES disponible sous INIES	
412		Mixer tap	1	/	1.0	Excluded in LCA model	10	VDI 2067 3.1.1	20% du coût d'un évier selon 412.61 BKI	0 - Pas de données environnementales associées	
412		Ceramic washbasins (2)	2	/	23.6	http://www.duravit.fr/website/homepage_fr/produits/nouveaux_produits/s%C3%A9ries/duraplus.fr-fr.html/p-92573	>50	DGNB 410	412.62 BKI	Lavabo en porcelaine de 60 cm et sa colonne, sans robinetterie ni vidage - FDES disponible sous INIES	
412		Mixer tap (1 per washbasin)	2	/	2.0	Excluded in LCA model	10	VDI 2067 3.1.1	Included in ceramic washbasins cost (in LCC: 20% considered for tap)	0 - Pas de données environnementales associées	
412		PEHD DN20 pipes	25	mct	2.8	Source: http://www.thaipipe.com/products&services/hdpepipe.htm	25	VDI 2067 3.1.2	http://www.brossette.fr/produits-en-ligne/tube-hd-serie-16-bar-polyethylene-diametre-20-lg-25-m/216056.html	_HDPE Pipe (Europe, 2005): production - Fiche ELODIE utilisateur	
412		Hot water pipes insulation (Armaflex 2.5 cm)	25	mct			20	VDI 2067 2.2	Technical sheet	_Styrene Butadiene Rubber: production - Fiche ELODIE utilisateur	
412		Other accessories (valves, pressure limiter,etc.)			6.5	Excluded in LCA model	15	VDI 2067 2.2.2	412.91 BKI BGF = 2360 m2	0 - Pas de données environnementales associées	
410 Sewerage, water and gas systems											

421	Heat generators	Condensing gas boiler	1	st	613.0		VDI 2067 1.3.1.1	Contact téléphonique Viessmann Lux (brûleur: 4000EUR, Régulation: hypothèse 4000EUR) Pour info: pour d'autres projets: 21382EUR pour 350kW, 12000EUR pour 160kW pose non included in boiler cost (in LCC: 20% considered for regulation)	Copie de * Chaudière gaz pour MI ttes technologies, P variée - Fiche ELODIE utilisateur	
421		Boiler regulation with probe	1	st	/	<i>Excluded in LCA model</i>	20	VDI 2067 1.2.4	0 - Pas de données environnementales associées	
421		DHW Cylinder 160L	1	st	65.0	http://www.chauffe-eau.fr/ftp/produits/GVSC26H/EG	25	VDI 2067 3.3.2	Poutrelle en acier - FDES disponible sous INIES	
422	Heat distribution networks	Steel pipes 1 in	132	mct	80.9	Pipes in steel (width 1 in) 7800 kg/m3	30	VDI 2067 1.2.7	_Ossature acier galvanisé (QEB Logement) - Fiche ELODIE utilisateur	
422		Steel pipes 2 in	480	mct	1 176.2	Pipes in steel (width 2 in) 7800 kg/m3	30	VDI 2067 1.2.7	_Ossature acier galvanisé (QEB Logement) - Fiche ELODIE utilisateur	
422		Steel pipes 4 in	172	mct	1 685.9	Pipes in steel (width 4 in) 7800 kg/m3	31	VDI 2067 1.2.8	_Ossature acier galvanisé (QEB Logement) - Fiche ELODIE utilisateur	
422		Steel pipes insulation (Armaflex 2.5 cm)	132	mct			20	VDI 2067 2.2	_Styrene Butadiene Rubber: production - Fiche ELODIE utilisateur	
422		Steel pipes insulation (Armaflex 3.2 cm)	480	mct			20	VDI 2067 2.2	_Styrene Butadiene Rubber: production - Fiche ELODIE utilisateur	
422		Steel pipes insulation (Armaflex 4.0 cm)	172	mct			20	VDI 2067 2.2	_Styrene Butadiene Rubber: production - Fiche ELODIE utilisateur	
422		Regulation pump	7	st	14.7	<i>Excluded in LCA model</i>	20	VDI 2067 1.2.1	0 - Pas de données environnementales associées	
422		Expansion tank 8L	4	st	22.0	http://www.chauffe-eau.fr/fr/acheter/pièces-detachees-pour-chaudiere/elm-leblanc/201.htm?page=4	25	VDI 2067 1.2.3	Poutrelle en acier - FDES disponible sous INIES	
422		Other (header, small pipes, etc.)			149.0	<i>Excluded in LCA model</i>	30	VDI 2067 1.2.7	0 - Pas de données environnementales associées	
423	Space heating	Fan coils	11	st	968.0	AERMEC UTF 28P	30	VDI 2067 1.1.1	Copie de "Ventiloconvecteur - Major Line - version carrossée taille 30 " - Fiche ELODIE utilisateur	
420 Heat supply systems										
430		Monobloc chiller	1	st	1 100.0	AERMEC NRA 550H version L (96 kW) Fluide R407C (0.21kg/kW => 21 kg de R407C)	15	VDI 2067 2.3.2.1.1	Poutrelle en acier - FDES disponible sous INIES	
430		Monobloc chiller (leakage)			1.575		1		_fuite de fluide frigorigène - Fiche ELODIE utilisateur	
430		Plate heat recovery	1	st	3 100.0	Total AHU weight	20	VDI 2067	Poutrelle en acier - FDES disponible sous INIES	
430		Heating coil	1	st		Included above	20	VDI 2067 2.1.2.1.3	0 - Pas de données environnementales associées	
430		Cooling coil	1	st		Included above	20	VDI 2067 2.1.3.1	0 - Pas de données environnementales associées	
430		Small air ducts	395	mct	2 158.9	Ducts in steel sheet (width 1 mm) 7800 kg/m3	20	VDI 2067 2.1.1	Bardage acier simple peau - FDES disponible sous INIES	
430		Medium air ducts	68	mct	477.4	Ducts in steel sheet (width 1 mm) 7800 kg/m3	20	VDI 2067 2.1.1	Bardage acier simple peau - FDES disponible sous INIES	
430		Big air ducts	6	mct	51.5	Ducts in steel sheet (width 1 mm) 7800 kg/m3	20	VDI 2067 2.1.1	Bardage acier simple peau - FDES disponible sous INIES	
430		Other (header, small pipes, etc.)			134.4	<i>Excluded in LCA model</i>	30	VDI 2067 1.2.7	0 - Pas de données environnementales associées	
430 Air treatment systems										

440	Wire 2.5 mm2 H07VU25	223	mct	7.9	Poids total, incluant cuivre et PVC. Détails: http://www.ombilicable.fr/index.php/fil/h07vu-h07vr/h07v-u-2-5mm-bleu.html	25	DGNB 440	http://www.ombilicable.fr/index.php/fil/h07vu-h07vr/h07v-u-2-5mm-bleu.html	_wire (copper + PVC) - Fiche ELODIE utilisateur
440	Wire 6 mm2 H07VR6	1491	mct	78.7	Poids total, incluant cuivre et PVC. Détails: http://www.ombilicable.fr/index.php/h07v-r-6mm-marron.html	25	DGNB 440	http://www.ombilicable.fr/index.php/h07v-r-6mm-marron.html	_wire (copper + PVC) 6mm ² - Fiche ELODIE utilisateur
440	Bare wire 35 mm2	35	mct	11.0	Copper density. 8960 kg/m3	25	DGNB 440	http://www.materielelectrique.com/cable-terre-cuivre-35mm2-prix-p-15672.html	_bare copper - Fiche ELODIE utilisateur
440	Electrical conduit ICTA 25mm	1516	mct	133.4	Poids total, incluant cuivre et PVC. Détails: http://www.ombilicable.fr/index.php/gaine/gaine-tire-fil-d25-c100.html	25	DGNB 440	http://www.ombilicable.fr/index.php/gaine/gaine-tire-fil-d25-c100.html	_electrical conduit - Fiche ELODIE utilisateur
440	Lighting 2*58W	332	st	956.2	http://www.luxoworks.com/en/database/zumtobel/42	25	DGNB 440	Devis hall WAKO; Bordereau ALLEVA Enzo architectes	_ Chartres Tube 32 W - Fiche ELODIE utilisateur

440 Power installations

450	Telecommunications and other	NA	NA	NA	NA				
460	commun	NA	NA	NA	NA				
470	Function-related equipment and fitm	NA	NA	NA	NA				
480	Building automation	NA	NA	NA	NA				
490	Other services - related work	NA	NA	NA	NA				

500 External works

510
520
530
540
550
560
570
590

600 Furnishings, furniture and artistic appointments

610
620

700 Incidental building costs

710
720
730
740
750
760
770
790

PART A - Bill of quantities - Cold Climate - Wall PU / Roof EPS
DIN 276-1 : 2008-12

Code	Designation	Building element	Quantity			Comment	Lifespan	Source		
			m ²	m ³	kg			Lifespan	LCC source	LCA source
330 External walls										
331	Loadbearing external walls	Steel structure			23 463.2		>50	BBSR	Contact téléphonique Arcelor Mittal (0.7 EUT/kg) x2 pose comprise	Poutrelle en acier - FDES disponible sous INIES
332	Non-loadbearing external walls	SO								
333	External columns	SO								
334	External doors and windows	Front band of window with metal frame	76.00	/	/	Frames included in the dimensions Frame height: 10 cm Frame width: 12 cm	40	BBSR	334.64 BKI	Fenêtre Aluminium Double vitrage - Fiche ELODIE CSTB
334		Window-door (front entry)	10.89	/	/	Frame U value: 1.2 W/m2K (steel) Glazing U value (band of window): 0.77 W/m2K Glazing U value (window-door): 0.76 W/m2K	40	BBSR	334.24 BKI	Porte d'entrée vitrée en aluminium BEL'M - FDES disponible sous INIES
334		Insulated metal doors (6 doors)	15.23	/	/	Hormann MZ Thermo U = 1,2 W/m2.K	40	BBSR	334.14 BKI	Porte d'entrée non vitrée en acier BEL'M - FDES disponible sous INIES
334		Sectional door	26.40	/	/	http://www.hormann.be/index.php?id=4310&L=5			334.14 BKI	_Industrial sectional doors with PU (polyurethane) foamed steel sections (company EPD) - Fiche ELODIE utilisateur
335	Cladding units	PU sandwich panel	976.81				>50	BBSR	Sandwich panels prices analysis	_PU foam core U 0.17 - Fiche ELODIE
335		Internal concrete blocks (9 cm)	146.28	13.17	25 013.5	Density: 1900 kg/m3	>50	BBSR	332.11 BKI	Mur en maçonnerie de blocs en béton - FDES disponible sous INIES
335		PU insulation (13.5 cm)	146.28	19.75	631.9	Density: 32 kg/m3 Lambda: 0.023W/m.K	>50	BBSR	Insulation price analysis	_PU thermal insulation board with aluminium facing with Credits (D) - Fiche ELODIE
335		External brick (9 cm)	162.53	14.63	23 404.5	Density: 1600 kg/m3 Lambda: 1.1 W/m.K http://www-energie2.arch.ucl.ac.be/transfert%20de%20chaleur/3.4.6.htm	>50	BBSR	332.16 BKI	Briques apparentes perforées - FDES disponible sous INIES
335		Concrete sill (9*25cm)	45.15	4.06	7 720.2	Density: 1900 kg/m3	>50	BBSR	332.11 BKI	Dalle de voirie en béton - FDES disponible sous INIES
335		Sandwich pannel bindings			14 438.4		>50	BBSR	Arcelor	Bardage acier simple peau - FDES disponible sous INIES
336	Internal linings (of external walls)	SO								
337	Prefabricated façade units	SO								
338	Solar protection	SO								
339	External walls, other items	SO								
340 Internal walls										
341	Loadbearing internal walls	Steel frame			8 753.5	Density: 7800 kg/m3	>50	BBSR	Arcelor	Poutrelle en acier - FDES disponible sous INIES
341		Concrete blocks between metal frame - 20 cm	412.22	82.44	156 642.5	Density: 1900 kg/m3	>50	BBSR	342.10 BKI	Mur en maçonnerie de blocs en béton - FDES disponible sous INIES
342	Non-loadbearing internal walls	Concrete blocks - 14 cm	376.69	52.74	100 198.3	Density: 1900 kg/m3	>50	BBSR	342.10 BKI	Mur en maçonnerie de blocs en béton - FDES disponible sous INIES
343	Internal columns	SO								
344	Internal doors and windows	Internal wood doors (10)	25.20	1.51	756.0	Density: 500kg/m3 http://www.allin.fr/index.php?option=com_content&view=article&id=75&Itemid=89#densité Thickness: 60 mm	>50	BBSR	344.12 BKI	* Porte Intérieure En Bois - Fiche ELODIE CSTB

345	Internal linings (of internal walls)	Plaster boards - 15 mm	1084.28	16.26	18 703.8	Densité: 1150 kg/m3 Lambda: 0.320 W/m.K	>50	BBSR	345.31 BKI	Plaque de plâtre KF BA15 - FDES disponible sous INIES	
345		Stoneware wall tiles (WC)	42.24	0.42	1 013.8	Density: 2400 kg/m3 http://cat.inist.fr/?aModele=afficheN&cpsidt=17173	>50	BBSR	345.53 BKI	Grès Cérame pleine masse (épaisseur moyenne 10 mm) - FDES disponible sous	
346	Prefabricated wall units	SO									
349	Internal walls, other items	SO									
350 Floors and ceilings											
351	Floor structures	Reinforced concrete slab ground floor (25 cm)	2294	573.50	1 376 400	Densité béton: 2400 kg/m3 Lambda: 2.200 W/m.K	>50	BBSR	351.10 BKI	Béton armé pour Dalles et Prédalles pour utilisation en Maison Individuelle - Fiche ELODIE CSTB	
351		Steel frame			5 754.0	Statics analysis assmption: 3.02 kN/m2	>50	BBSR	Arcelor	Poutrelle en acier - FDES disponible sous	
351		Metal staircases (2)	2.00	st		Escaliers en acier pour atteindre chaque côté du niveau +1 du stock à partir de la zone de déchargement à l'arrière. Largeur: 1m, Hauteur: 3m	>50	BBSR	351.70 BKI	_Ossature acier galvanisé (QEB Logement) - Fiche ELODIE utilisateur	
351		Hollow core slab - h=16 cm, 1st floor	286.44	/	88 180.3	Statics analysis assmption: 3.02 kN/m2	>50	BBSR	351.25 BKI	Plancher Seacbois sur poutrelle - FDES disponible sous INIES	
352	Floorings	Concrete screed - 10 cm	2294.00	229.40	412 920.0	Densité béton: 1800 kg/m3 Lambda: 1.500 W/m.K	>50	BBSR	352.21 BKI	Chape fluide béton autoplaçante C25 XF1 (liant ciment) épaisseur 5 cm - FDES disponible sous INIES	
352		Pu insulation - 120 mm	2294.00	275.28	8 809.0	Density: 32 kg/m3	>50	BBSR	Insulation price analysis	_PU thermal insulation board with aluminium facing - Fiche ELODIE utilisateur	
352		Stoneware floor tiles (all surfaces exept technical and storage rooms)	1913.27	19.13	45 918.5	Density: 2400 kg/m3 http://cat.inist.fr/?aModele=afficheN&cpsidt=17173	>50	BBSR	352.31 BKI	Grès Cérame pleine masse (épaisseur moyenne 10 mm) - FDES disponible sous INIES	
352		Compression slab - 5 cm	286.44	14.32	36 498.5	Statics analysis assmption: 1.25 kN/m2	>50	BBSR	352.21 BKI	Semelle filante 40x40 cm en béton armé C25/30 XF1 CEM II A - FDES plus disponible	
352		Concrete screed - 5 cm	286.44	14.32	29 198.8	Statics analysis assmption: 1 kN/m2	>50	BBSR	Included in compression slab cost (in LCC: 20% considered for concrete screed)	Chape fluide béton autoplaçante C25 XF1 (liant ciment) épaisseur 5 cm - FDES disponible sous INIES	
353	Ceiling linings	Ceiling linings	299.44		1 197.8	Fond-plafond minéral, 4kg/m2	>50	BBSR	353.87 BKI	Panneau de laine de roche EQUATION 20 mm - FDES disponible sous INIES	
353		Metal studs for ceiling linings	299.44		595.6	Fixation 0.51 kg/ml, 3.9ml/m2	>50	BBSR	Included in ceiling linings cost (in LCC: 20% considered for metal studs)	_Ossature acier galvanisé (QEB Logement) - Fiche ELODIE utilisateur	
359	Floors and ceilings, other items	SO									
360 Roofs											
361	Roof structure	Steel frame			91 592.6	Density: 7800 kg/m3	>50	BBSR	Arcelor	Poutrelle en acier - FDES disponible sous	
362	Roof lights, roof openings	SO									
363	Roof coverings	Waterproofing membrane (bitumen)	2434.78	/	15 217.4		>50	BBSR	363.11 BKI	Membrane d'étanchéité synthétique fixée mécaniquement - FDES disponible sous	
363		EPS insulation - 500 mm	2310.82	1155.41	28 885.2	Density: 25 kg/m3 lambda 0.035 W/m.K	>50	BBSR	Insulation price analysis	_Expanded Polystyrene (EPS) Foam Insulation - Fiche ELODIE utilisateur	
363		Vapour-barrier	2310.82	/	/	6.039	>50	BBSR	Source: idem que part B	_polypropylene (PP, Europe, 2005): Production - Fiche ELODIE utilisateur	
363		Roofing sheet trapezoidal	2263.06		27 925.4		1.9088	>50	BBSR	Arcelor	Bardage acier simple peau - FDES disponible sous INIES
364	Roof linings	SO					6 000.68				
369	Roofs, other items	Rainwater gutter	162.81	mct			>50	BBSR	369.12 BKI	_zinc : production - Fiche ELODIE utilisateur	
369		Rainwater pipes (8)	51.2	mct			>50	BBSR	369.11 BKI	_zinc : production - Fiche ELODIE utilisateur	

344	Internal doors and windows	Internal wood doors (10)	25.20	1.51	756.0	Density: 500kg/m3 http://www.allin.fr/index.php?option=com_content&view=article&id=75&Itemid=89#densité Thickness: 60 mm	>50	BBSR	344.12 BKI	* Porte Intérieure En Bois - Fiche ELODIE CSTB
345	Internal linings (of internal walls)	Plaster boards - 15 mm	1084.28	16.26	18 703.8	Densité: 1150 kg/m3 Lambda: 0.320 W/m.K	>50	BBSR	345.31 BKI	Plaque de plâtre KF BA15 - FDES disponible sous INIES
345		Stoneware wall tiles (WC)	42.24	0.42	1 013.8	Density: 2400 kg/m3 http://cat.inist.fr/?aModele=afficheN&cpsid=1717373	>50	BBSR	345.53 BKI	Grès Cérame pleine masse (épaisseur moyenne 10 mm) - FDES disponible sous INIES
346	Prefabricated wall units	SO								
349	Internal walls, other items	SO								
350 Floors and ceilings										
351	Floor structures	Reinforced concrete slab ground floor (25 cm)	2294	573.50	1 376 400	Densité béton: 2400 kg/m3 Lambda: 2.200 W/m.K	>50	BBSR	351.10 BKI	Béton armé pour Dalles et Prédalles pour utilisation en Maison Individuelle - Fiche ELODIE CSTB
351		Steel frame			5 754.0	Statics analysis assmption: 3.02 kN/m2	>50	BBSR	Arcelor	Poutrelle en acier - FDES disponible sous INIES
351		Metal staircases (2)	2.00	st		Escaliers en acier pour atteindre chaque côté du niveau +1 du stock à partir de la zone de déchargement à l'arrière. Largeur: 1m, Hauteur: 3m	>50	BBSR	351.70 BKI	_Ossature acier galvanisé (QEB Logement) - Fiche ELODIE utilisateur
351		Hollow core slab - h=16 cm, 1st floor	286.44	/	88 180.3	Statics analysis assmption: 3.02 kN/m2	>50	BBSR	351.25 BKI	Plancher Seacbois sur poutrelle - FDES disponible sous INIES
352	Floorings	Concrete screed - 10 cm	2294.00	229.40	412 920.0	Densité béton: 1800 kg/m3 Lambda: 1.500 W/m.K	>50	BBSR	352.21 BKI	Chape fluide béton autoplaçante C25 XF1 (liant ciment) épaisseur 5 cm - FDES disponible sous INIES
352		Pu insulation - 120 mm	2294.00	275.28	8 809.0	Density: 32 kg/m3	>50	BBSR	Insulation price analysis	_PU thermal insulation board with aluminium facing - Fiche ELODIE utilisateur
352		Stoneware floor tiles (all surfaces exsept technical and storage rooms)	1913.27	19.13	45 918.5	Density: 2400 kg/m3 http://cat.inist.fr/?aModele=afficheN&cpsid=1717373	>50	BBSR	352.31 BKI	Grès Cérame pleine masse (épaisseur moyenne 10 mm) - FDES disponible sous INIES
352		Compression slab - 5 cm	286.44	14.32	36 498.5	Statics analysis assmption: 1.25 kN/m2	>50	BBSR	352.21 BKI	Semelle filante 40x40 cm en béton armé C25/30 XF1 CEM II A - FDES plus disponible sous INIES
352		Concrete screed - 5 cm	286.44	14.32	29 198.8	Statics analysis assmption: 1 kN/m2	>50	BBSR	Included in compression slab cost (in LCC: 20% considered for concrete screed)	Chape fluide béton autoplaçante C25 XF1 (liant ciment) épaisseur 5 cm - FDES disponible sous INIES
353	Ceiling linings	Ceiling linings	299.44		1 197.8	Fond-plafond minéral, 4kg/m2	>50	BBSR	353.87 BKI	Panneau de laine de roche EQUATION 20
353		Metal studs for ceiling	299.44		595.6	Fixation 0.51 kg/ml, 3.9ml/m2	>50	BBSR	Included in ceiling linings cost (in	_Ossature acier galvanisé (QEB Logement) -
359	Floors and ceilings, other items	SO								
360 Roofs										
361	Roof structure	Steel frame			94 557.2	Density: 7800 kg/m3	>50	BBSR	Arcelor	Poutrelle en acier - FDES disponible sous INIES
362	Roof lights, roof openings	SO								
363	Roof coverings	Waterproofing membrane (bitumen)	2434.78	/	15 217.4		>50	BBSR	363.11 BKI +/-26€/m2 p. 74, 168, 189	Membrane d'étanchéité synthétique fixée mécaniquement - FDES disponible sous INIES
363		SW insulation - 570 mm	2310.82	1317.17	197 574.8	Density: 150 kg/m3 lambda 0.040 W/m.K	>50	BBSR	Insulation price analysis	Panneau rigide en laine de roche THERMIPAN 333 épaisseur 80 mm - FDES disponible sous INIES
363		Vapour-barrier	2310.82	/	/		>50	BBSR	Source: idem que part B	_polypropylene (PP, Europe, 2005): Production - Fiche ELODIE utilisateur
363		Roofing sheet trapezoidal	2263.06		31 727.3		>50	BBSR	Arcelor	Bardage acier simple peau - FDES disponible sous INIES
364	Roof linings	SO								
369	Roofs, other items	Rainwater gutter	162.81	mct			>50	BBSR	369.12 BKI	_zinc : production - Fiche ELODIE utilisateur
369		Rainwater pipes (8)	51.2	mct			>50	BBSR	369.11 BKI	_zinc : production - Fiche ELODIE utilisateur

344	Internal doors and windows	Internal wood doors (10)	25.20	1.51	756.0	Density: 500kg/m3 http://www.allin.fr/index.php?option=com_content&view=article&id=75&Itemid=89#densité Thickness: 60 mm	>50	BBSR	344.12 BKI	* Porte Intérieure En Bois - Fiche ELODIE CSTB
345	Internal linings (of internal walls)	Plaster boards - 15 mm	1084.28	16.26	18 703.8	Densité: 1150 kg/m3 Lambda: 0.320 W/m.K	>50	BBSR	345.31 BKI	Plaque de plâtre KF BA15 - FDES disponible sous INIES
345		Stoneware wall tiles (WC)	42.24	0.42	1 013.8	Density: 2400 kg/m3 http://cat.inist.fr/?aModele=afficheN&cpsid=1717373	>50	BBSR	345.53 BKI	Grès Cérame pleine masse (épaisseur moyenne 10 mm) - FDES disponible sous INIES
346	Prefabricated wall units	SO								
349	Internal walls, other items	SO								
350 Floors and ceilings										
351	Floor structures	Reinforced concrete slab ground floor (25 cm)	2294	573.50	1 376 400	Densité béton: 2400 kg/m3 Lambda: 2.200 W/m.K	>50	BBSR	351.10 BKI	Béton armé pour Dalles et Prédalles pour utilisation en Maison Individuelle - Fiche ELODIE CSTB
351		Steel frame			5 754.0	Statics analysis assmption: 3.02 kN/m2	>50	BBSR	Arcelor	Poutrelle en acier - FDES disponible sous INIES
351		Metal staircases (2)	2.00	st		Escaliers en acier pour atteindre chaque côté du niveau +1 du stock à partir de la zone de déchargement à l'arrière. Largeur: 1m, Hauteur: 3m	>50	BBSR	351.70 BKI	_Ossature acier galvanisé (QEB Logement) - Fiche ELODIE utilisateur
351		Hollow core slab - h=16 cm, 1st floor	286.44	/	88 180.3	Statics analysis assmption: 3.02 kN/m2	>50	BBSR	351.25 BKI	Plancher Seacbois sur poutrelle - FDES disponible sous INIES
352	Floorings	Concrete screed - 10 cm	2294.00	229.40	412 920.0	Densité béton: 1800 kg/m3 Lambda: 1.500 W/m.K	>50	BBSR	352.21 BKI	Chape fluide béton autoplaçante C25 XF1 (liant ciment) épaisseur 5 cm - FDES disponible sous INIES
352		Pu insulation - 120 mm	2294.00	275.28	8 809.0	Density: 32 kg/m3	>50	BBSR	Insulation price analysis	_PU thermal insulation board with aluminium facing - Fiche ELODIE utilisateur
352		Stoneware floor tiles (all surfaces exept technical and storage rooms)	1913.27	19.13	45 918.5	Density: 2400 kg/m3 http://cat.inist.fr/?aModele=afficheN&cpsid=1717373	>50	BBSR	352.31 BKI	Grès Cérame pleine masse (épaisseur moyenne 10 mm) - FDES disponible sous INIES
352		Compression slab - 5 cm	286.44	14.32	36 498.5	Statics analysis assmption: 1.25 kN/m2	>50	BBSR	352.21 BKI	Semelle filante 40x40 cm en béton armé C25/30 XF1 CEM II A - FDES plus disponible sous INIES
352		Concrete screed - 5 cm	286.44	14.32	29 198.8	Statics analysis assmption: 1 kN/m2	>50	BBSR	Included in compression slab cost (in LCC: 20% considered for concrete screed)	Chape fluide béton autoplaçante C25 XF1 (liant ciment) épaisseur 5 cm - FDES disponible sous INIES
353	Ceiling linings	Ceiling linings	299.44		1 197.8	Fond-plafond minéral, 4kg/m2	>50	BBSR	353.87 BKI	Panneau de laine de roche EQUATION 20
353		Metal studs for ceiling	299.44		595.6	Fixation 0.51 kg/ml, 3.9ml/m2	>50	BBSR	Included in ceiling linings cost (in	_Ossature acier galvanisé (QEB Logement) -
359	Floors and ceilings, other items	SO								
360 Roofs										
361	Roof structure	Steel frame			91 592.6	Density: 7800 kg/m3	>50	BBSR	Arcelor	Poutrelle en acier - FDES disponible sous INIES
362	Roof lights, roof openings	SO								
363	Roof coverings	Waterproofing membrane (bitumen)	2434.78	/	15 217.4		>50	BBSR	363.11 BKI +/-26€/m2 p. 74, 168, 189	Membrane d'étanchéité synthétique fixée mécaniquement - FDES disponible sous INIES
363		EPS insulation - 500 mm	2310.82	1155.41	28 885.2	Density: 25 kg/m3 lambda 0.035 W/m.K	>50	BBSR	Insulation price analysis	_Expanded Polystyrene (EPS) Foam Insulation - Fiche ELODIE utilisateur
363		Vapour-barrier	2310.82	/	/		>50	BBSR	Source: idem que part B	_polypropylene (PP, Europe, 2005): Production - Fiche ELODIE utilisateur
363		Roofing sheet trapezoidal	2263.06		27 925.4		>50	BBSR	Arcelor	Bardage acier simple peau - FDES disponible sous INIES
364	Roof linings	SO								
369	Roofs, other items	Rainwater gutter	162.81	mct			>50	BBSR	369.12 BKI	_zinc : production - Fiche ELODIE utilisateur
369		Rainwater pipes (8)	51.2	mct			>50	BBSR	369.11 BKI	

PART A - Bill of quantities - Moderate Climate - Wall PU / Roof PU
DIN 276-1 : 2008-12

Code	Designation	Building element	Quantity			Comment	Lifespan	Source		LCA source	
			m ²	m ³	kg			Lifespan	LCC source		
300 Structure - construction											
330 External walls											
331	Loadbearing external walls	Steel structure			20 657.2		>50	BBSR	Contact téléphonique Arcelor Mittal (0.7 EUT/kg) x2 pose comprise	Poutrelle en acier - FDES disponible sous INIES	
332	Non-loadbearing external walls	SO									
333	External columns	SO									
334	External doors and windows	Front band of window with metal frame	76.00	/	/	Frames included in the dimensions Frame height: 10 cm Frame width: 12 cm	40	BBSR	334.64 BKI	Fenêtre Aluminium Double vitrage - Fiche ELODIE CSTB	
334		Window-door (front entry)	10.89	/	/	Frame U value: 1.2 W/m2K (steel) Glazing U value (band of window): 0.77 W/m2K Glazing U value (window-door):0.76 W/m2K	40	BBSR	334.24 BKI	Porte d'entrée vitrée en aluminium BEL'M - FDES disponible sous INIES	
334		Insulated metal doors (6 doors)	15.23	/	/	Hormann MZ Thermo U = 1,2 W/m2.K	40	BBSR	334.14 BKI	Porte d'entrée non vitrée en acier BEL'M - FDES disponible sous INIES	
334		Sectional door	26.40	/	/	http://www.hormann.be/index.php?id=4310&L=5			334.14 BKI	_Industrial sectional doors with PU (polyurethane) foamed steel sections (company EPD) - Fiche ELODIE utilisateur	
335	Cladding units	PU sandwich panel	976.81			12 356.6	>50	BBSR	Sandwich panels prices analysis	_PU foam core U 0.17 - Fiche ELODIE utilisateur	
335		Internal concrete blocks (9 cm)	146.28	13.17	25 013.5	Density: 1900 kg/m3	>50	BBSR	332.11 BKI	Mur en maçonnerie de blocs en béton - FDES disponible sous INIES	
335		PU insulation (13.5 cm)	146.28	19.75	631.9	Density: 32 kg/m3 Lambda: 0.023W/m.K	>50	BBSR	Insulation price analysis	_PU thermal insulation board with aluminium facing with Credits (D) - Fiche ELODIE utilisateur	
335		External brick (9 cm)	162.53	14.63	23 404.5	Density: 1600 kg/m3 Lambda: 1.1 W/m.K http://www-energie2.arch.ucl.ac.be/transfert%20de%20chaleur/3.4.6.htm	>50	BBSR	332.16 BKI	Briques apparentes perforées - FDES disponible sous INIES	
335		Concrete sill (9*25cm)	45.15	4.06	7 720.2	Density: 1900 kg/m3	>50	BBSR	332.11 BKI	Dalle de voirie en béton - FDES disponible sous INIES	
335		Sandwich pannel bindings				14 438.4	>50	BBSR	Arcelor	Bardage acier simple peau - FDES disponible sous INIES	
336	Internal linings (of external walls)	SO									
337	Prefabricated façade units	SO									
338	Solar protection	SO									
339	External walls, other items	SO									
340 Internal walls											
341	Loadbearing internal walls	Steel frame				7 655.5	Density: 7800 kg/m3	>50	BBSR	Arcelor	Poutrelle en acier - FDES disponible sous INIES
341		Concrete blocks between metal frame - 20 cm	412.22	82.44	156 642.5	Density: 1900 kg/m3	>50	BBSR	342.10 BKI	Mur en maçonnerie de blocs en béton - FDES disponible sous INIES	
342	Non-loadbearing internal walls	Concrete blocks - 14 cm	376.69	52.74	100 198.3	Density: 1900 kg/m3	>50	BBSR	342.10 BKI	Mur en maçonnerie de blocs en béton - FDES disponible sous INIES	
343	Internal columns	SO									
344	Internal doors and windows	Internal wood doors (10)	25.20	1.51	756.0	Density: 500kg/m3 http://www.allin.fr/index.php?option=com_content&view=article&id=75&Itemid=89#densité Thickness: 60 mm	>50	BBSR	344.12 BKI	* Porte Intérieure En Bois - Fiche ELODIE CSTB	

345	Internal linings (of internal walls)	Plaster boards - 15 mm	1084.28	16.26	18 703.8	Densité: 1150 kg/m3 Lambda: 0.320 W/m.K	>50	BBSR	345.31 BKI	Plaque de plâtre KF BA15 - FDES disponible sous INIES
345		Stoneware wall tiles (WC)	42.24	0.42	1 013.8	Density: 2400 kg/m3 http://cat.inist.fr/?aModele=afficheN&cpsid=1717373	>50	BBSR	345.53 BKI	Grès Cérame pleine masse (épaisseur moyenne 10 mm) - FDES disponible sous INIES
346	Prefabricated wall units	SO								
349	Internal walls, other items	SO								
350 Floors and ceilings										
351	Floor structures	Reinforced concrete slab ground floor (25 cm)	2294	573.50	1 376 400	Densité béton: 2400 kg/m3 Lambda: 2.200 W/m.K	>50	BBSR	351.10 BKI	Béton armé pour Dalles et Prédalles pour utilisation en Maison Individuelle - Fiche ELODIE CSTB
351		Steel frame			5 754.0	Statics analysis assumption: 3.02 kN/m2	>50	BBSR	Arcelor	Poutrelle en acier - FDES disponible sous INIES
351		Metal staircases (2)	2.00	st		Escaliers en acier pour atteindre chaque côté du niveau +1 du stock à partir de la zone de déchargement à l'arrière. Largeur: 1m, Hauteur: 3m	>50	BBSR	351.70 BKI	_Ossature acier galvanisé (QEB Logement) - Fiche ELODIE utilisateur
351		Hollow core slab - h=16 cm, 1st floor	286.44	/	88 180.3	Statics analysis assumption: 3.02 kN/m2	>50	BBSR	351.25 BKI	Plancher Seacbois sur poutrelle - FDES disponible sous INIES
352	Floorings	Concrete screed - 10 cm	2294.00	229.40	412 920.0	Densité béton: 1800 kg/m3 Lambda: 1.500 W/m.K	>50	BBSR	352.21 BKI	Chape fluide béton autoplaçante C25 XF1 (liant ciment) épaisseur 5 cm - FDES disponible sous INIES
352		Pu insulation - 120 mm	2294.00	275.28	8 809.0	Density: 32 kg/m3	>50	BBSR	Insulation price analysis	_PU thermal insulation board with aluminium facing - Fiche ELODIE utilisateur
352		Stoneware floor tiles (all surfaces except technical and storage rooms)	1913.27	19.13	45 918.5	Density: 2400 kg/m3 http://cat.inist.fr/?aModele=afficheN&cpsid=1717373	>50	BBSR	352.31 BKI	Grès Cérame pleine masse (épaisseur moyenne 10 mm) - FDES disponible sous INIES
352		Compression slab - 5 cm	286.44	14.32	36 498.5	Statics analysis assumption: 1.25 kN/m2	>50	BBSR	352.21 BKI	Semelle filante 40x40 cm en béton armé C25/30 XF1 CEM II A - FDES plus disponible sous INIES
352		Concrete screed - 5 cm	286.44	14.32	29 198.8	Statics analysis assumption: 1 kN/m2	>50	BBSR	Included in compression slab cost (in LCC: 20% considered for concrete screed)	Chape fluide béton autoplaçante C25 XF1 (liant ciment) épaisseur 5 cm - FDES disponible sous INIES
353	Ceiling linings	Ceiling linings	299.44		1 197.8	Fond-plafond minéral, 4kg/m2	>50	BBSR	353.87 BKI	Panneau de laine de roche EQUATION 20 mm - FDES disponible sous INIES
353		Metal studs for ceiling linings	299.44		595.6	Fixation 0.51 kg/ml, 3.9ml/m2	>50	BBSR	Included in ceiling linings cost (in LCC: 20% considered for metal studs)	_Ossature acier galvanisé (QEB Logement) - Fiche ELODIE utilisateur
359	Floors and ceilings, other items	SO								
360 Roofs										
361	Roof structure	Steel frame			56 509.0	Density: 7800 kg/m3	>50	BBSR	Arcelor	Poutrelle en acier - FDES disponible sous INIES
362	Roof lights, roof openings	SO								
363	Roof coverings	Waterproofing membrane (bitumen)	2434.78	/	15 217.4		>50	BBSR	363.11 BKI +/-26€/m2 p. 74, 168, 189	Membrane d'étanchéité synthétique fixée mécaniquement - FDES disponible sous INIES
363		Pu insulation - 145 mm	2310.82	335.07	10 722.2	Density: 32 kg/m3 lambda 0.023 W/m.K	>50	BBSR	Insulation price analysis	_PU thermal insulation board with aluminium facing with Credits (D) - Fiche ELODIE utilisateur
363		Vapour-barrier	2310.82	/	/		>50	BBSR	Source: idem que part B	_polypropylene (PP, Europe, 2005): Production - Fiche ELODIE utilisateur
363		Roofing sheet trapezoidal	2263.06		21 498.5		>50	BBSR	Arcelor	Bardage acier simple peau - FDES disponible sous INIES
364	Roof linings	SO								
369	Roofs, other items	Rainwater gutter	162.81	mct			>50	BBSR	369.12 BKI	_zinc : production - Fiche ELODIE utilisateur
369		Rainwater pipes (8)	51.2	mct			>50	BBSR	369.11 BKI	

344	Internal doors and windows	Internal wood doors (10)	25.20	1.51	756.0	Density: 500kg/m3 http://www.allin.fr/index.php?option=com_content&view=article&id=75&Itemid=89#densité Thickness: 60 mm	>50	BBSR	344.12 BKI	* Porte Intérieure En Bois - Fiche ELODIE CSTB
345	Internal linings (of internal walls)	Plaster boards - 15 mm	1084.28	16.26	18 703.8	Densité: 1150 kg/m3 Lambda: 0.320 W/m.K	>50	BBSR	345.31 BKI	Plaque de plâtre KF BA15 - FDES disponible sous INIES
345		Stoneware wall tiles (WC)	42.24	0.42	1 013.8	Density: 2400 kg/m3 http://cat.inist.fr/?aModele=afficheN&cpsid=17173	>50	BBSR	345.53 BKI	Grès Cérame pleine masse (épaisseur moyenne 10 mm) - FDES disponible sous INIES
346	Prefabricated wall units	SO								
349	Internal walls, other items	SO								
350 Floors and ceilings										
351	Floor structures	Reinforced concrete slab ground floor (25 cm)	2294	573.50	1 376 400	Densité béton: 2400 kg/m3 Lambda: 2.200 W/m.K	>50	BBSR	351.10 BKI	Béton armé pour Dalles et Prédalles pour utilisation en Maison Individuelle - Fiche ELODIE CSTB
351		Steel frame			5 754.0	Statics analysis assumption: 3.02 kN/m2	>50	BBSR	Arcelor	Poutrelle en acier - FDES disponible sous INIES
351		Metal staircases (2)	2.00	st		Escaliers en acier pour atteindre chaque côté du niveau +1 du stock à partir de la zone de déchargement à l'arrière. Largeur: 1m, Hauteur: 3m	>50	BBSR	351.70 BKI	_Ossature acier galvanisé (QEB Logement) - Fiche ELODIE utilisateur
351		Hollow core slab - h=16 cm, 1st floor	286.44	/	88 180.3	Statics analysis assumption: 3.02 kN/m2	>50	BBSR	351.25 BKI	Plancher Seaocbois sur poutrelle - FDES disponible sous INIES
352	Floorings	Concrete screed - 10 cm	2294.00	229.40	412 920.0	Densité béton: 1800 kg/m3 Lambda: 1.500 W/m.K	>50	BBSR	352.21 BKI	Chape fluide béton autoplaçante C25 XF1 (liant ciment) épaisseur 5 cm - FDES disponible sous INIES
352		Pu insulation - 120 mm	2294.00	275.28	8 809.0	Density: 32 kg/m3	>50	BBSR	Insulation price analysis	_PU thermal insulation board with aluminium facing - Fiche ELODIE utilisateur
352		Stoneware floor tiles (all surfaces except technical and storage rooms)	1913.27	19.13	45 918.5	Density: 2400 kg/m3 http://cat.inist.fr/?aModele=afficheN&cpsid=17173	>50	BBSR	352.31 BKI	Grès Cérame pleine masse (épaisseur moyenne 10 mm) - FDES disponible sous INIES
352		Compression slab - 5 cm	286.44	14.32	36 498.5	Statics analysis assumption: 1.25 kN/m2	>50	BBSR	352.21 BKI	Semelle filante 40x40 cm en béton armé C25/30 XF1 CEM II A - FDES plus disponible sous INIES
352		Concrete screed - 5 cm	286.44	14.32	29 198.8	Statics analysis assumption: 1 kN/m2	>50	BBSR	Included in compression slab cost (in LCC: 20% considered for concrete screed)	Chape fluide béton autoplaçante C25 XF1 (liant ciment) épaisseur 5 cm - FDES disponible sous INIES
353	Ceiling linings	Ceiling linings	299.44		1 197.8	Fond-plafond minéral, 4kg/m2	>50	BBSR	353.87 BKI	Panneau de laine de roche EQUATION 20
353		Metal studs for ceiling	299.44		595.6	Fixation 0.51 kg/ml, 3.9ml/m2	>50	BBSR	Included in ceiling linings cost (in	_Ossature acier galvanisé (QEB Logement) -
359	Floors and ceilings, other items	SO								
360 Roofs										
361	Roof structure	Steel frame			56 509.0	Density: 7800 kg/m3	>50	BBSR	Arcelor	Poutrelle en acier - FDES disponible sous INIES
362	Roof lights, roof openings	SO								
363	Roof coverings	Waterproofing membrane (bitumen)	2434.78	/	15 217.4		>50	BBSR	363.11 BKI +/-26€/m2 p. 74, 168, 189	Membrane d'étanchéité synthétique fixée mécaniquement - FDES disponible sous INIES
363		EPS insulation - 220 mm	2310.82	508.38	12 709.5	Density: 25 kg/m3 lambda 0.035 W/m.K	>50	BBSR	Insulation price analysis	_Expanded Polystyrene (EPS) Foam Insulation - Fiche ELODIE utilisateur
363		Vapour-barrier	2310.82	/	/		>50	BBSR	Source: idem que part B	_polypropylene (PP, Europe, 2005): Production - Fiche ELODIE utilisateur
363		Roofing sheet trapezoidal	2263.06		21 498.5		>50	BBSR	Arcelor	Bardage acier simple peau - FDES disponible sous INIES
364	Roof linings	SO								
369	Roofs, other items	Rainwater gutter	162.81	mct			>50	BBSR	369.12 BKI	_zinc : production - Fiche ELODIE utilisateur
369		Rainwater pipes (8)	51.2	mct			>50	BBSR	369.11 BKI	_zinc : production - Fiche ELODIE utilisateur

344	Internal doors and windows	Internal wood doors (10)	25.20	1.51	756.0	Density: 500kg/m3 http://www.allin.fr/index.php?option=com_content&view=article&id=75&Itemid=89#densité Thickness: 60 mm	>50	BBSR	344.12 BKI	* Porte Intérieure En Bois - Fiche ELODIE CSTB
345	Internal linings (of internal walls)	Plaster boards - 15 mm	1084.28	16.26	18 703.8	Densité: 1150 kg/m3 Lambda: 0.320 W/m.K	>50	BBSR	345.31 BKI	Plaque de plâtre KF BA15 - FDES disponible sous INIES
345		Stoneware wall tiles (WC)	42.24	0.42	1 013.8	Density: 2400 kg/m3 http://cat.inist.fr/?aModele=afficheN&cpsid=1717373	>50	BBSR	345.53 BKI	Grès Cérame pleine masse (épaisseur moyenne 10 mm) - FDES disponible sous INIES
346	Prefabricated wall units	SO								
349	Internal walls, other items	SO								
350 Floors and ceilings										
351	Floor structures	Reinforced concrete slab ground floor (25 cm)	2294	573.50	1 376 400	Densité béton: 2400 kg/m3 Lambda: 2.200 W/m.K	>50	BBSR	351.10 BKI	Béton armé pour Dalles et Prédalles pour utilisation en Maison Individuelle - Fiche ELODIE CSTB
351		Steel frame			5 754.0	Statics analysis assmption: 3.02 kN/m2	>50	BBSR	Arcelor	Poutrelle en acier - FDES disponible sous INIES
351		Metal staircases (2)	2.00	st		Escaliers en acier pour atteindre chaque côté du niveau +1 du stock à partir de la zone de déchargement à l'arrière. Largeur: 1m, Hauteur: 3m	>50	BBSR	351.70 BKI	_Ossature acier galvanisé (QEB Logement) - Fiche ELODIE utilisateur
351		Hollow core slab - h=16 cm, 1st floor	286.44	/	88 180.3	Statics analysis assmption: 3.02 kN/m2	>50	BBSR	351.25 BKI	Plancher Seacbois sur poutrelle - FDES disponible sous INIES
352	Floorings	Concrete screed - 10 cm	2294.00	229.40	412 920.0	Densité béton: 1800 kg/m3 Lambda: 1.500 W/m.K	>50	BBSR	352.21 BKI	Chape fluide béton autoplaçante C25 XF1 (liant ciment) épaisseur 5 cm - FDES disponible sous INIES
352		Pu insulation - 120 mm	2294.00	275.28	8 809.0	Density: 32 kg/m3	>50	BBSR	Insulation price analysis	_PU thermal insulation board with aluminium facing - Fiche ELODIE utilisateur
352		Stoneware floor tiles (all surfaces exsept technical and storage rooms)	1913.27	19.13	45 918.5	Density: 2400 kg/m3 http://cat.inist.fr/?aModele=afficheN&cpsid=1717373	>50	BBSR	352.31 BKI	Grès Cérame pleine masse (épaisseur moyenne 10 mm) - FDES disponible sous INIES
352		Compression slab - 5 cm	286.44	14.32	36 498.5	Statics analysis assmption: 1.25 kN/m2	>50	BBSR	352.21 BKI	Semelle filante 40x40 cm en béton armé C25/30 XF1 CEM II A - FDES plus disponible sous INIES
352		Concrete screed - 5 cm	286.44	14.32	29 198.8	Statics analysis assmption: 1 kN/m2	>50	BBSR	Included in compression slab cost (in LCC: 20% considered for concrete screed)	Chape fluide béton autoplaçante C25 XF1 (liant ciment) épaisseur 5 cm - FDES disponible sous INIES
353	Ceiling linings	Ceiling linings	299.44		1 197.8	Fond-plafond minéral, 4kg/m2	>50	BBSR	353.87 BKI	Panneau de laine de roche EQUATION 20
353		Metal studs for ceiling	299.44		595.6	Fixation 0.51 kg/ml, 3.9ml/m2	>50	BBSR	Included in ceiling linings cost (in	_Ossature acier galvanisé (QEB Logement) -
359	Floors and ceilings, other items	SO								
360 Roofs										
361	Roof structure	Steel frame			62 749.0	Density: 7800 kg/m3	>50	BBSR	Arcelor	Poutrelle en acier - FDES disponible sous INIES
362	Roof lights, roof openings	SO								
363	Roof coverings	Waterproofing membrane (bitumen)	2434.78	/	15 217.4		>50	BBSR	363.11 BKI +/-26€/m2 p. 74, 168, 189	Membrane d'étanchéité synthétique fixée mécaniquement - FDES disponible sous INIES
363		SW insulation - 250 mm	2310.82	577.70	86 655.6	Density: 150 kg/m3 lambda 0.040 W/m.K	>50	BBSR	Insulation price analysis	Panneau rigide en laine de roche THERMIPAN 333 épaisseur 80 mm - FDES disponible sous INIES
363		Vapour-barrier	2310.82	/	/		>50	BBSR	Source: idem que part B	_polypropylene (PP, Europe, 2005): Production - Fiche ELODIE utilisateur
363		Roofing sheet trapezoidal	2263.06		23 784.1		>50	BBSR	Arcelor	Bardage acier simple peau - FDES disponible sous INIES
364	Roof linings	SO								
369	Roofs, other items	Rainwater gutter	162.81	mct			>50	BBSR	369.12 BKI	_zinc : production - Fiche ELODIE utilisateur
369		Rainwater pipes (8)	51.2	mct			>50	BBSR	369.11 BKI	_zinc : production - Fiche ELODIE utilisateur

344	Internal doors and windows	Internal wood doors (10)	25.20	1.51	756.0	Density: 500kg/m3 http://www.allin.fr/index.php?option=com_content&view=article&id=75&Itemid=89#densité Thickness: 60 mm	>50	BBSR	344.12 BKI	* Porte Intérieure En Bois - Fiche ELODIE CSTB
345	Internal linings (of internal walls)	Plaster boards - 15 mm	1084.28	16.26	18 703.8	Densité: 1150 kg/m3 Lambda: 0.320 W/m.K	>50	BBSR	345.31 BKI	Plaque de plâtre KF BA15 - FDES disponible sous INIES
345		Stoneware wall tiles (WC)	42.24	0.42	1 013.8	Density: 2400 kg/m3 http://cat.inist.fr/?aModele=afficheN&cpsid=1717373	>50	BBSR	345.53 BKI	Grès Cérame pleine masse (épaisseur moyenne 10 mm) - FDES disponible sous INIES
346	Prefabricated wall units	SO								
349	Internal walls, other items	SO								
350 Floors and ceilings										
351	Floor structures	Reinforced concrete slab ground floor (25 cm)	2294	573.50	1 376 400	Densité béton: 2400 kg/m3 Lambda: 2.200 W/m.K	>50	BBSR	351.10 BKI	Béton armé pour Dalles et Prédalles pour utilisation en Maison Individuelle - Fiche ELODIE CSTB
351		Steel frame			5 754.0	Statics analysis assumption: 3.02 kN/m2	>50	BBSR	Arcelor	Poutrelle en acier - FDES disponible sous INIES
351		Metal staircases (2)	2.00	st		Escaliers en acier pour atteindre chaque côté du niveau +1 du stock à partir de la zone de déchargement à l'arrière. Largeur: 1m, Hauteur: 3m	>50	BBSR	351.70 BKI	_Ossature acier galvanisé (QEB Logement) - Fiche ELODIE utilisateur
351		Hollow core slab - h=16 cm, 1st floor	286.44	/	88 180.3	Statics analysis assumption: 3.02 kN/m2	>50	BBSR	351.25 BKI	Plancher Seacbois sur poutrelle - FDES disponible sous INIES
352	Floorings	Concrete screed - 10 cm	2294.00	229.40	412 920.0	Densité béton: 1800 kg/m3 Lambda: 1.500 W/m.K	>50	BBSR	352.21 BKI	Chape fluide béton autoplaçante C25 XF1 (liant ciment) épaisseur 5 cm - FDES disponible sous INIES
352		Pu insulation - 120 mm	2294.00	275.28	8 809.0	Density: 32 kg/m3	>50	BBSR	Insulation price analysis	_PU thermal insulation board with aluminium facing - Fiche ELODIE utilisateur
352		Stoneware floor tiles (all surfaces except technical and storage rooms)	1913.27	19.13	45 918.5	Density: 2400 kg/m3 http://cat.inist.fr/?aModele=afficheN&cpsid=1717373	>50	BBSR	352.31 BKI	Grès Cérame pleine masse (épaisseur moyenne 10 mm) - FDES disponible sous INIES
352		Compression slab - 5 cm	286.44	14.32	36 498.5	Statics analysis assumption: 1.25 kN/m2	>50	BBSR	352.21 BKI	Semelle filante 40x40 cm en béton armé C25/30 XF1 CEM II A - FDES plus disponible sous INIES
352		Concrete screed - 5 cm	286.44	14.32	29 198.8	Statics analysis assumption: 1 kN/m2	>50	BBSR	Included in compression slab cost (in LCC: 20% considered for concrete screed)	Chape fluide béton autoplaçante C25 XF1 (liant ciment) épaisseur 5 cm - FDES disponible sous INIES
353	Ceiling linings	Ceiling linings	299.44		1 197.8	Fond-plafond minéral, 4kg/m2	>50	BBSR	353.87 BKI	Panneau de laine de roche EQUATION 20
353		Metal studs for ceiling	299.44		595.6	Fixation 0.51 kg/ml, 3.9ml/m2	>50	BBSR	Included in ceiling linings cost (in	_Ossature acier galvanisé (QEB Logement) -
359	Floors and ceilings, other items	SO								
360 Roofs										
361	Roof structure	Steel frame			56 509.0	Density: 7800 kg/m3	>50	BBSR	Arcelor	Poutrelle en acier - FDES disponible sous INIES
362	Roof lights, roof openings	SO								
363	Roof coverings	Waterproofing membrane (bitumen)	2434.78	/	15 217.4		>50	BBSR	363.11 BKI +/-26€/m2 p. 74, 168, 189	Membrane d'étanchéité synthétique fixée mécaniquement - FDES disponible sous INIES
363		EPS insulation - 220 mm	2310.82	508.38	12 709.5	Density: 25 kg/m3 lambda 0.035 W/m.K	>50	BBSR	Insulation price analysis	_Expanded Polystyrene (EPS) Foam Insulation - Fiche ELODIE utilisateur
363		Vapour-barrier	2310.82	/	/		>50	BBSR	Source: idem que part B	_polypropylene (PP, Europe, 2005): Production - Fiche ELODIE utilisateur
363		Roofing sheet trapezoidal	2263.06		21 498.5		>50	BBSR	Arcelor	Bardage acier simple peau - FDES disponible sous INIES
364	Roof linings	SO								
369	Roofs, other items	Rainwater gutter	162.81	mct			>50	BBSR	369.12 BKI	_zinc : production - Fiche ELODIE utilisateur
369		Rainwater pipes (8)	51.2	mct			>50	BBSR	369.11 BKI	_zinc : production - Fiche ELODIE utilisateur

344	Internal doors and windows	Internal wood doors (10)	25.20	1.51	756.0	Density: 500kg/m3 http://www.allin.fr/index.php?option=com_content&view=article&id=75&Itemid=89#densité Thickness: 60 mm	>50	BBSR	344.12 BKI	* Porte Intérieure En Bois - Fiche ELODIE CSTB
345	Internal linings (of internal walls)	Plaster boards - 15 mm	1084.28	16.26	18 703.8	Densité: 1150 kg/m3 Lambda: 0.320 W/m.K	>50	BBSR	345.31 BKI	Plaque de plâtre KF BA15 - FDES disponible sous INIES
345		Stoneware wall tiles (WC)	42.24	0.42	1 013.8	Density: 2400 kg/m3 http://cat.inist.fr/?aModele=afficheN&cpsid=1717373	>50	BBSR	345.53 BKI	Grès Cérame pleine masse (épaisseur moyenne 10 mm) - FDES disponible sous INIES
346	Prefabricated wall units	SO								
349	Internal walls, other items	SO								
350 Floors and ceilings										
351	Floor structures	Reinforced concrete slab ground floor (25 cm)	2294	573.50	1 376 400	Densité béton: 2400 kg/m3 Lambda: 2.200 W/m.K	>50	BBSR	351.10 BKI	Béton armé pour Dalles et Prédalles pour utilisation en Maison Individuelle - Fiche ELODIE CSTB
351		Steel frame			5 754.0	Statics analysis assmption: 3.02 kN/m2	>50	BBSR	Arcelor	Poutrelle en acier - FDES disponible sous INIES
351		Metal staircases (2)	2.00	st		Escaliers en acier pour atteindre chaque côté du niveau +1 du stock à partir de la zone de déchargement à l'arrière. Largeur: 1m, Hauteur: 3m	>50	BBSR	351.70 BKI	_Ossature acier galvanisé (QEB Logement) - Fiche ELODIE utilisateur
351		Hollow core slab - h=16 cm, 1st floor	286.44	/	88 180.3	Statics analysis assmption: 3.02 kN/m2	>50	BBSR	351.25 BKI	Plancher Seacbois sur poutrelle - FDES disponible sous INIES
352	Floorings	Concrete screed - 10 cm	2294.00	229.40	412 920.0	Densité béton: 1800 kg/m3 Lambda: 1.500 W/m.K	>50	BBSR	352.21 BKI	Chape fluide béton autoplaçante C25 XF1 (liant ciment) épaisseur 5 cm - FDES disponible sous INIES
352		Pu insulation - 60 mm	2294.00	137.64	4 404.5	Density: 32 kg/m3	>50	BBSR	Insulation price analysis	_PU thermal insulation board with aluminium facing - Fiche ELODIE utilisateur
352		Stoneware floor tiles (all surfaces exsept technical and storage rooms)	1913.27	19.13	45 918.5	Density: 2400 kg/m3 http://cat.inist.fr/?aModele=afficheN&cpsid=1717373	>50	BBSR	352.31 BKI	Grès Cérame pleine masse (épaisseur moyenne 10 mm) - FDES disponible sous INIES
352		Compression slab - 5 cm	286.44	14.32	36 498.5	Statics analysis assmption: 1.25 kN/m2	>50	BBSR	352.21 BKI	Semelle filante 40x40 cm en béton armé C25/30 XF1 CEM II A - FDES plus disponible sous INIES
352		Concrete screed - 5 cm	286.44	14.32	29 198.8	Statics analysis assmption: 1 kN/m2	>50	BBSR	Included in compression slab cost (in LCC: 20% considered for concrete screed)	Chape fluide béton autoplaçante C25 XF1 (liant ciment) épaisseur 5 cm - FDES disponible sous INIES
353	Ceiling linings	Ceiling linings	299.44		1 197.8	Fond-plafond minéral, 4kg/m2	>50	BBSR	353.87 BKI	Panneau de laine de roche EQUATION 20
353		Metal studs for ceiling	299.44		595.6	Fixation 0.51 kg/ml, 3.9ml/m2	>50	BBSR	Included in ceiling linings cost (in	_Ossature acier galvanisé (QEB Logement) -
359	Floors and ceilings, other items	SO								
360 Roofs										
361	Roof structure	Steel frame			56 509.0	Density: 7800 kg/m3	>50	BBSR	Arcelor	Poutrelle en acier - FDES disponible sous INIES
362	Roof lights, roof openings	SO								
363	Roof coverings	Waterproofing membrane (bitumen)	2434.78	/	15 217.4		>50	BBSR	363.11 BKI +/-26€/m2 p. 74, 168, 189	Membrane d'étanchéité synthétique fixée mécaniquement - FDES disponible sous INIES
363		Pu insulation - 130 mm	2310.82	300.41	9 613.0	Density: 32 kg/m3 lambda 0.023 W/m.K	>50	BBSR	Insulation price analysis	_PU thermal insulation board with aluminium facing with Credits (D) - Fiche ELODIE utilisateur
363		Vapour-barrier	2310.82	/	/		>50	BBSR	Source: idem que part B	_polypropylene (PP, Europe, 2005): Production - Fiche ELODIE utilisateur
363		Roofing sheet trapezoidal	2263.06		21 498.5		>50	BBSR	Arcelor	Bardage acier simple peau - FDES disponible sous INIES
364	Roof linings	SO								
369	Roofs, other items	Rainwater gutter	162.81	mct			>50	BBSR	369.12 BKI	_zinc : production - Fiche ELODIE utilisateur
369		Rainwater pipes (8)	51.2	mct			>50	BBSR	369.11 BKI	_zinc : production - Fiche ELODIE utilisateur

344	Internal doors and windows	Internal wood doors (10)	25.20	1.51	756.0	Density: 500kg/m3 http://www.allin.fr/index.php?option=com_content&view=article&id=75&Itemid=89#densité Thickness: 60 mm	>50	BBSR	344.12 BKI	* Porte Intérieure En Bois - Fiche ELODIE CSTB
345	Internal linings (of internal walls)	Plaster boards - 15 mm	1084.28	16.26	18 703.8	Densité: 1150 kg/m3 Lambda: 0.320 W/m.K	>50	BBSR	345.31 BKI	Plaque de plâtre KF BA15 - FDES disponible sous INIES
345		Stoneware wall tiles (WC)	42.24	0.42	1 013.8	Density: 2400 kg/m3 http://cat.inist.fr/?aModele=afficheN&cpsid=1717373	>50	BBSR	345.53 BKI	Grès Cérame pleine masse (épaisseur moyenne 10 mm) - FDES disponible sous INIES
346	Prefabricated wall units	SO								
349	Internal walls, other items	SO								
350 Floors and ceilings										
351	Floor structures	Reinforced concrete slab ground floor (25 cm)	2294	573.50	1 376 400	Densité béton: 2400 kg/m3 Lambda: 2.200 W/m.K	>50	BBSR	351.10 BKI	Béton armé pour Dalles et Prédalles pour utilisation en Maison Individuelle - Fiche ELODIE CSTB
351		Steel frame			5 754.0	Statics analysis assmption: 3.02 kN/m2	>50	BBSR	Arcelor	Poutrelle en acier - FDES disponible sous INIES
351		Metal staircases (2)	2.00	st		Escaliers en acier pour atteindre chaque côté du niveau +1 du stock à partir de la zone de déchargement à l'arrière. Largeur: 1m, Hauteur: 3m	>50	BBSR	351.70 BKI	_Ossature acier galvanisé (QEB Logement) - Fiche ELODIE utilisateur
351		Hollow core slab - h=16 cm, 1st floor	286.44	/	88 180.3	Statics analysis assmption: 3.02 kN/m2	>50	BBSR	351.25 BKI	Plancher Seacbois sur poutrelle - FDES disponible sous INIES
352	Floorings	Concrete screed - 10 cm	2294.00	229.40	412 920.0	Densité béton: 1800 kg/m3 Lambda: 1.500 W/m.K	>50	BBSR	352.21 BKI	Chape fluide béton autoplaçante C25 XF1 (liant ciment) épaisseur 5 cm - FDES disponible sous INIES
352		Pu insulation - 60 mm	2294.00	137.64	4 404.5	Density: 32 kg/m3	>50	BBSR	Insulation price analysis	_PU thermal insulation board with aluminium facing - Fiche ELODIE utilisateur
352		Stoneware floor tiles (all surfaces exsept technical and storage rooms)	1913.27	19.13	45 918.5	Density: 2400 kg/m3 http://cat.inist.fr/?aModele=afficheN&cpsid=1717373	>50	BBSR	352.31 BKI	Grès Cérame pleine masse (épaisseur moyenne 10 mm) - FDES disponible sous INIES
352		Compression slab - 5 cm	286.44	14.32	36 498.5	Statics analysis assmption: 1.25 kN/m2	>50	BBSR	352.21 BKI	Semelle filante 40x40 cm en béton armé C25/30 XF1 CEM II A - FDES plus disponible sous INIES
352		Concrete screed - 5 cm	286.44	14.32	29 198.8	Statics analysis assmption: 1 kN/m2	>50	BBSR	Included in compression slab cost (in LCC: 20% considered for concrete screed)	Chape fluide béton autoplaçante C25 XF1 (liant ciment) épaisseur 5 cm - FDES disponible sous INIES
353	Ceiling linings	Ceiling linings	299.44		1 197.8	Fond-plafond minéral, 4kg/m2	>50	BBSR	353.87 BKI	Panneau de laine de roche EQUATION 20
353		Metal studs for ceiling	299.44		595.6	Fixation 0.51 kg/ml, 3.9ml/m2	>50	BBSR	Included in ceiling linings cost (in	_Ossature acier galvanisé (QEB Logement) -
359	Floors and ceilings, other items	SO								
360 Roofs										
361	Roof structure	Steel frame			56 509.0	Density: 7800 kg/m3	>50	BBSR	Arcelor	Poutrelle en acier - FDES disponible sous INIES
362	Roof lights, roof openings	SO								
363	Roof coverings	Waterproofing membrane (bitumen)	2434.78	/	15 217.4		>50	BBSR	363.11 BKI +/-26€/m2 p. 74, 168, 189	Membrane d'étanchéité synthétique fixée mécaniquement - FDES disponible sous INIES
363		EPS insulation - 195 mm	2310.82	450.61	11 265.2	Density: 25 kg/m3 lambda 0.035 W/m.K	>50	BBSR	Insulation price analysis	_Expanded Polystyrene (EPS) Foam Insulation - Fiche ELODIE utilisateur
363		Vapour-barrier	2310.82	/	/		>50	BBSR	Source: idem que part B	_polypropylene (PP, Europe, 2005): Production - Fiche ELODIE utilisateur
363		Roofing sheet trapezoidal	2263.06		21 498.5		>50	BBSR	Arcelor	Bardage acier simple peau - FDES disponible sous INIES
364	Roof linings	SO								
369	Roofs, other items	Rainwater gutter	162.81	mct			>50	BBSR	369.12 BKI	_zinc : production - Fiche ELODIE utilisateur
369		Rainwater pipes (8)	51.2	mct			>50	BBSR	369.11 BKI	_zinc : production - Fiche ELODIE utilisateur

344	Internal doors and windows	Internal wood doors (10)	25.20	1.51	756.0	Density: 500kg/m3 http://www.allin.fr/index.php?option=com_content&view=article&id=75&Itemid=89#densité Thickness: 60 mm	>50	BBSR	344.12 BKI	* Porte Intérieure En Bois - Fiche ELODIE CSTB
345	Internal linings (of internal walls)	Plaster boards - 15 mm	1084.28	16.26	18 703.8	Densité: 1150 kg/m3 Lambda: 0.320 W/m.K	>50	BBSR	345.31 BKI	Plaque de plâtre KF BA15 - FDES disponible sous INIES
345		Stoneware wall tiles (WC)	42.24	0.42	1 013.8	Density: 2400 kg/m3 http://cat.inist.fr/?aModele=afficheN&cpsid=1717373	>50	BBSR	345.53 BKI	Grès Cérame pleine masse (épaisseur moyenne 10 mm) - FDES disponible sous INIES
346	Prefabricated wall units	SO								
349	Internal walls, other items	SO								
350 Floors and ceilings										
351	Floor structures	Reinforced concrete slab ground floor (25 cm)	2294	573.50	1 376 400	Densité béton: 2400 kg/m3 Lambda: 2.200 W/m.K	>50	BBSR	351.10 BKI	Béton armé pour Dalles et Prédalles pour utilisation en Maison Individuelle - Fiche ELODIE CSTB
351		Steel frame			5 754.0	Statics analysis assumption: 3.02 kN/m2	>50	BBSR	Arcelor	Poutrelle en acier - FDES disponible sous INIES
351		Metal staircases (2)	2.00	st		Escaliers en acier pour atteindre chaque côté du niveau +1 du stock à partir de la zone de déchargement à l'arrière. Largeur: 1m, Hauteur: 3m	>50	BBSR	351.70 BKI	_Ossature acier galvanisé (QEB Logement) - Fiche ELODIE utilisateur
351		Hollow core slab - h=16 cm, 1st floor	286.44	/	88 180.3	Statics analysis assumption: 3.02 kN/m2	>50	BBSR	351.25 BKI	Plancher Seacbois sur poutrelle - FDES disponible sous INIES
352	Floorings	Concrete screed - 10 cm	2294.00	229.40	412 920.0	Densité béton: 1800 kg/m3 Lambda: 1.500 W/m.K	>50	BBSR	352.21 BKI	Chape fluide béton autoplaçante C25 XF1 (liant ciment) épaisseur 5 cm - FDES disponible sous INIES
352		Pu insulation - 60 mm	2294.00	137.64	4 404.5	Density: 32 kg/m3	>50	BBSR	Insulation price analysis	_PU thermal insulation board with aluminium facing - Fiche ELODIE utilisateur
352		Stoneware floor tiles (all surfaces except technical and storage rooms)	1913.27	19.13	45 918.5	Density: 2400 kg/m3 http://cat.inist.fr/?aModele=afficheN&cpsid=1717373	>50	BBSR	352.31 BKI	Grès Cérame pleine masse (épaisseur moyenne 10 mm) - FDES disponible sous INIES
352		Compression slab - 5 cm	286.44	14.32	36 498.5	Statics analysis assumption: 1.25 kN/m2	>50	BBSR	352.21 BKI	Semelle filante 40x40 cm en béton armé C25/30 XF1 CEM II A - FDES plus disponible sous INIES
352		Concrete screed - 5 cm	286.44	14.32	29 198.8	Statics analysis assumption: 1 kN/m2	>50	BBSR	Included in compression slab cost (in LCC: 20% considered for concrete screed)	Chape fluide béton autoplaçante C25 XF1 (liant ciment) épaisseur 5 cm - FDES disponible sous INIES
353	Ceiling linings	Ceiling linings	299.44		1 197.8	Fond-plafond minéral, 4kg/m2	>50	BBSR	353.87 BKI	Panneau de laine de roche EQUATION 20
353		Metal studs for ceiling	299.44		595.6	Fixation 0.51 kg/ml, 3.9ml/m2	>50	BBSR	Included in ceiling linings cost (in	_Ossature acier galvanisé (QEB Logement) -
359	Floors and ceilings, other items	SO								
360 Roofs										
361	Roof structure	Steel frame			62 749.0	Density: 7800 kg/m3	>50	BBSR	Arcelor	Poutrelle en acier - FDES disponible sous INIES
362	Roof lights, roof openings	SO								
363	Roof coverings	Waterproofing membrane (bitumen)	2434.78	/	15 217.4		>50	BBSR	363.11 BKI +/-26€/m2 p. 74, 168, 189	Membrane d'étanchéité synthétique fixée mécaniquement - FDES disponible sous INIES
363		SW insulation - 220 mm	2310.82	508.38	76 256.9	Density: 150 kg/m3 lambda 0.040 W/m.K	>50	BBSR	Insulation price analysis	Panneau rigide en laine de roche THERMIPAN 333 épaisseur 80 mm - FDES disponible sous INIES
363		Vapour-barrier	2310.82	/	/		>50	BBSR	Source: idem que part B	_polypropylene (PP, Europe, 2005): Production - Fiche ELODIE utilisateur
363		Roofing sheet trapezoidal	2263.06		23 784.1		>50	BBSR	Arcelor	Bardage acier simple peau - FDES disponible sous INIES
364	Roof linings	SO								
369	Roofs, other items	Rainwater gutter	162.81	mct			>50	BBSR	369.12 BKI	_zinc : production - Fiche ELODIE utilisateur
369		Rainwater pipes (8)	51.2	mct			>50	BBSR	369.11 BKI	_zinc : production - Fiche ELODIE utilisateur

344	Internal doors and windows	Internal wood doors (10)	25.20	1.51	756.0	Density: 500kg/m3 http://www.allin.fr/index.php?option=com_content&view=article&id=75&Itemid=89#densité Thickness: 60 mm	>50	BBSR	344.12 BKI	* Porte Intérieure En Bois - Fiche ELODIE CSTB
345	Internal linings (of internal walls)	Plaster boards - 15 mm	1084.28	16.26	18 703.8	Densité: 1150 kg/m3 Lambda: 0.320 W/m.K	>50	BBSR	345.31 BKI	Plaque de plâtre KF BA15 - FDES disponible sous INIES
345		Stoneware wall tiles (WC)	42.24	0.42	1 013.8	Density: 2400 kg/m3 http://cat.inist.fr/?aModele=afficheN&cpsid=1717373	>50	BBSR	345.53 BKI	Grès Cérame pleine masse (épaisseur moyenne 10 mm) - FDES disponible sous INIES
346	Prefabricated wall units	SO								
349	Internal walls, other items	SO								
350 Floors and ceilings										
351	Floor structures	Reinforced concrete slab ground floor (25 cm)	2294	573.50	1 376 400	Densité béton: 2400 kg/m3 Lambda: 2.200 W/m.K	>50	BBSR	351.10 BKI	Béton armé pour Dalles et Prédalles pour utilisation en Maison Individuelle - Fiche ELODIE CSTB
351		Steel frame			5 754.0	Statics analysis assumption: 3.02 kN/m2	>50	BBSR	Arcelor	Poutrelle en acier - FDES disponible sous INIES
351		Metal staircases (2)	2.00	st		Escaliers en acier pour atteindre chaque côté du niveau +1 du stock à partir de la zone de déchargement à l'arrière. Largeur: 1m, Hauteur: 3m	>50	BBSR	351.70 BKI	_Ossature acier galvanisé (QEB Logement) - Fiche ELODIE utilisateur
351		Hollow core slab - h=16 cm, 1st floor	286.44	/	88 180.3	Statics analysis assumption: 3.02 kN/m2	>50	BBSR	351.25 BKI	Plancher Seacbois sur poutrelle - FDES disponible sous INIES
352	Floorings	Concrete screed - 10 cm	2294.00	229.40	412 920.0	Densité béton: 1800 kg/m3 Lambda: 1.500 W/m.K	>50	BBSR	352.21 BKI	Chape fluide béton autoplaçante C25 XF1 (liant ciment) épaisseur 5 cm - FDES disponible sous INIES
352		Pu insulation - 60 mm	2294.00	137.64	4 404.5	Density: 32 kg/m3	>50	BBSR	Insulation price analysis	_PU thermal insulation board with aluminium facing - Fiche ELODIE utilisateur
352		Stoneware floor tiles (all surfaces except technical and storage rooms)	1913.27	19.13	45 918.5	Density: 2400 kg/m3 http://cat.inist.fr/?aModele=afficheN&cpsid=1717373	>50	BBSR	352.31 BKI	Grès Cérame pleine masse (épaisseur moyenne 10 mm) - FDES disponible sous INIES
352		Compression slab - 5 cm	286.44	14.32	36 498.5	Statics analysis assumption: 1.25 kN/m2	>50	BBSR	352.21 BKI	Semelle filante 40x40 cm en béton armé C25/30 XF1 CEM II A - FDES plus disponible sous INIES
352		Concrete screed - 5 cm	286.44	14.32	29 198.8	Statics analysis assumption: 1 kN/m2	>50	BBSR	Included in compression slab cost (in LCC: 20% considered for concrete screed)	Chape fluide béton autoplaçante C25 XF1 (liant ciment) épaisseur 5 cm - FDES disponible sous INIES
353	Ceiling linings	Ceiling linings	299.44		1 197.8	Fond-plafond minéral, 4kg/m2	>50	BBSR	353.87 BKI	Panneau de laine de roche EQUATION 20
353		Metal studs for ceiling	299.44		595.6	Fixation 0.51 kg/ml, 3.9ml/m2	>50	BBSR	Included in ceiling linings cost (in	_Ossature acier galvanisé (QEB Logement) -
359	Floors and ceilings, other items	SO								
360 Roofs										
361	Roof structure	Steel frame			56 509.0	Density: 7800 kg/m3	>50	BBSR	Arcelor	Poutrelle en acier - FDES disponible sous INIES
362	Roof lights, roof openings	SO								
363	Roof coverings	Waterproofing membrane (bitumen)	2434.78	/	15 217.4		>50	BBSR	363.11 BKI +/-26€/m2 p. 74, 168, 189	Membrane d'étanchéité synthétique fixée mécaniquement - FDES disponible sous INIES
363		EPS insulation - 195 mm	2310.82	450.61	11 265.2	Density: 25 kg/m3 lambda 0.035 W/m.K	>50	BBSR	Insulation price analysis	_Expanded Polystyrene (EPS) Foam Insulation - Fiche ELODIE utilisateur
363		Vapour-barrier	2310.82	/	/		>50	BBSR	Source: idem que part B	_polypropylene (PP, Europe, 2005): Production - Fiche ELODIE utilisateur
363		Roofing sheet trapezoidal	2263.06		21 498.5		>50	BBSR	Arcelor	Bardage acier simple peau - FDES disponible sous INIES
364	Roof linings	SO								
369	Roofs, other items	Rainwater gutter	162.81	mct			>50	BBSR	369.12 BKI	_zinc : production - Fiche ELODIE utilisateur
369		Rainwater pipes (8)	51.2	mct			>50	BBSR	369.11 BKI	_zinc : production - Fiche ELODIE utilisateur

Appendix E. - *Building drawings*

Drawing

Concrete slab
for external
monobloc
chiller

54270

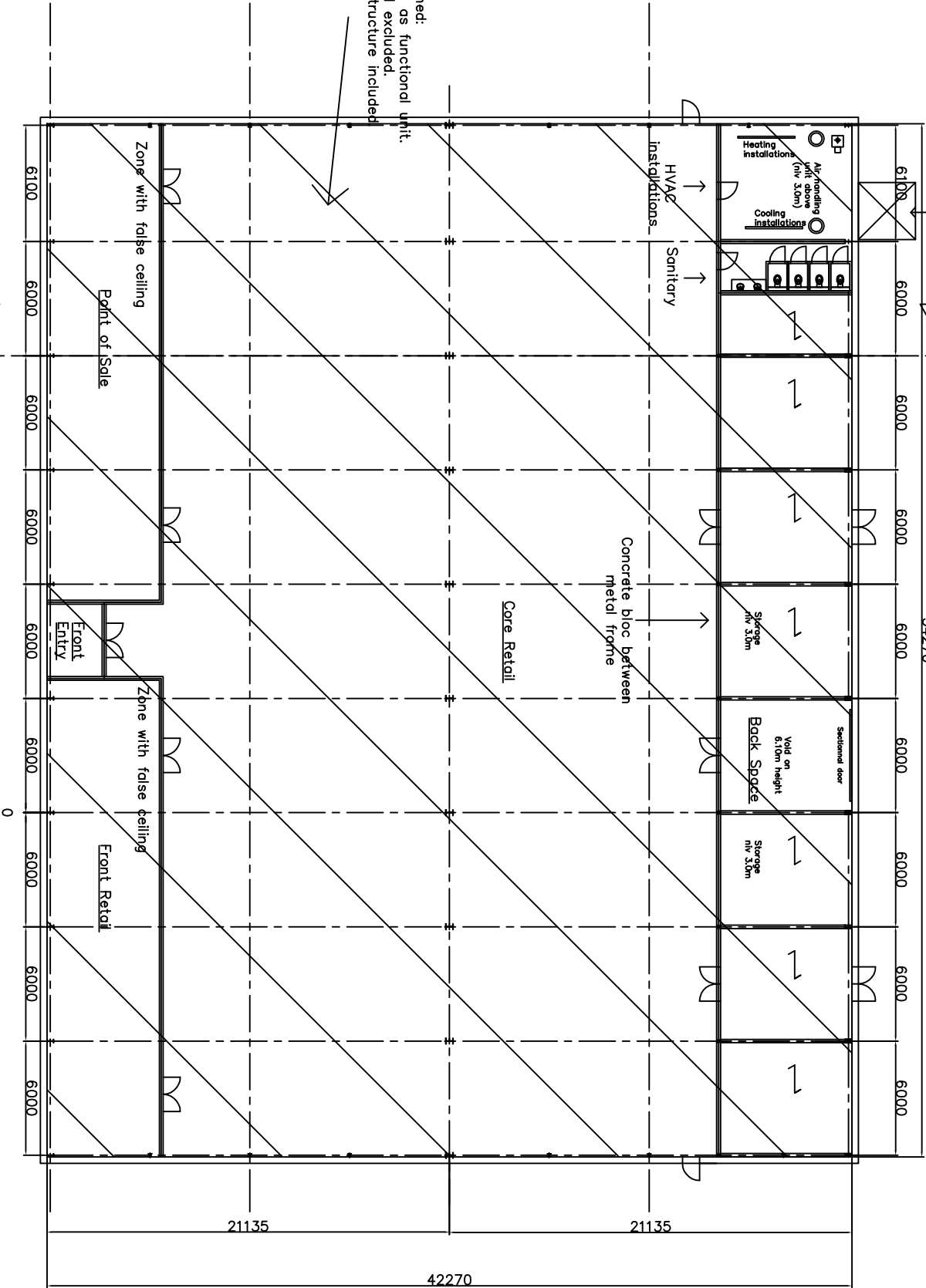

A

0

Drawing
Reference building stand alone retail
Version: draft for discussion purposes only
Date : 1/10/2012

Section drawing A-A

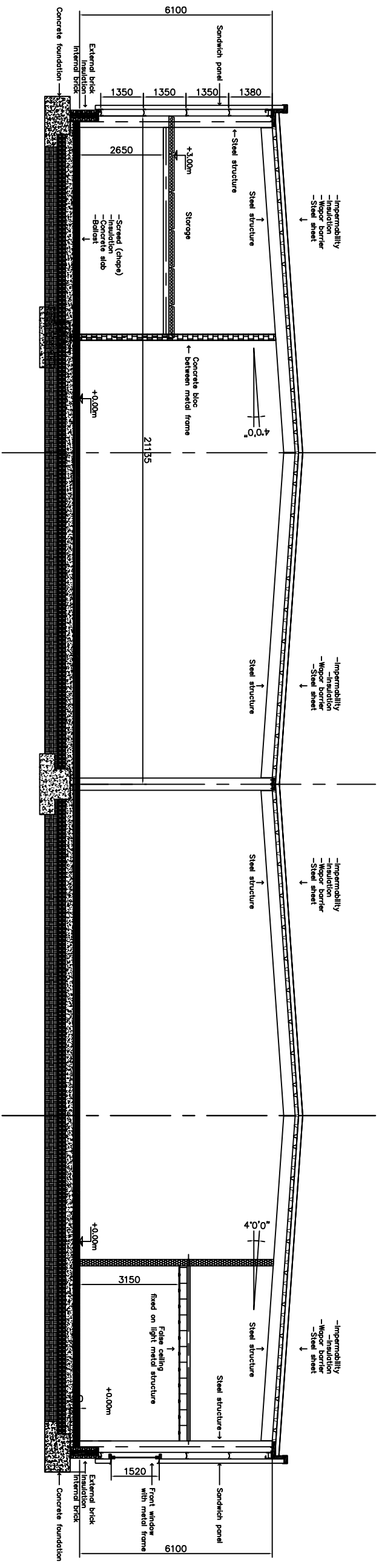

Section drawing A-A

Reference building stand alone retail

Version: draft for discussion purposes only

Date : 1/10/2012

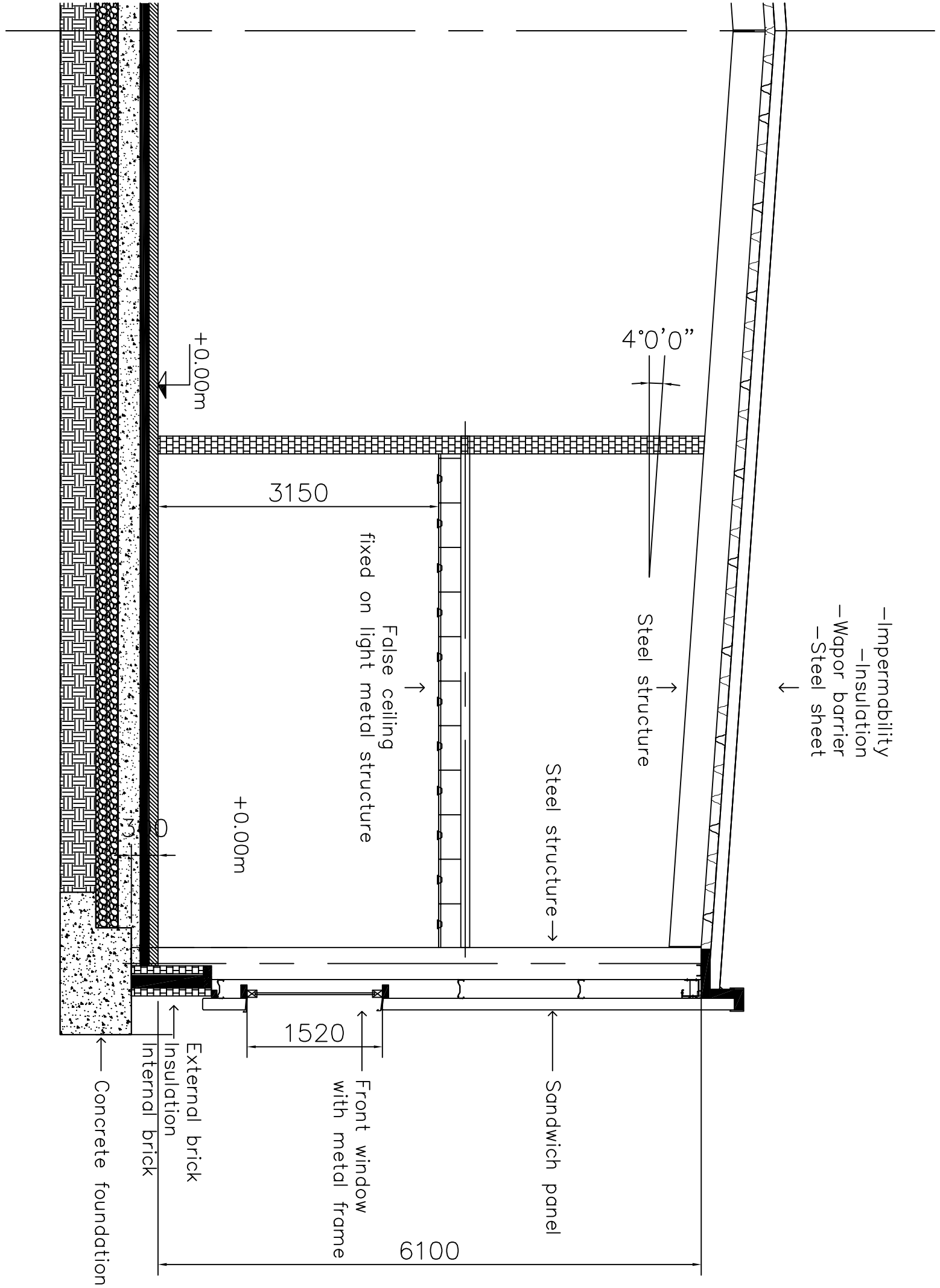

- Impermeability
- Insulation
- Vapor barrier
- Steel sheet

Steel structure →

Steel structure ↑

False ceiling
fixed on light metal structure ↑

Concrete foundation
Internal brick
Insulation
External brick

Front window
with metal frame

Sandwich panel

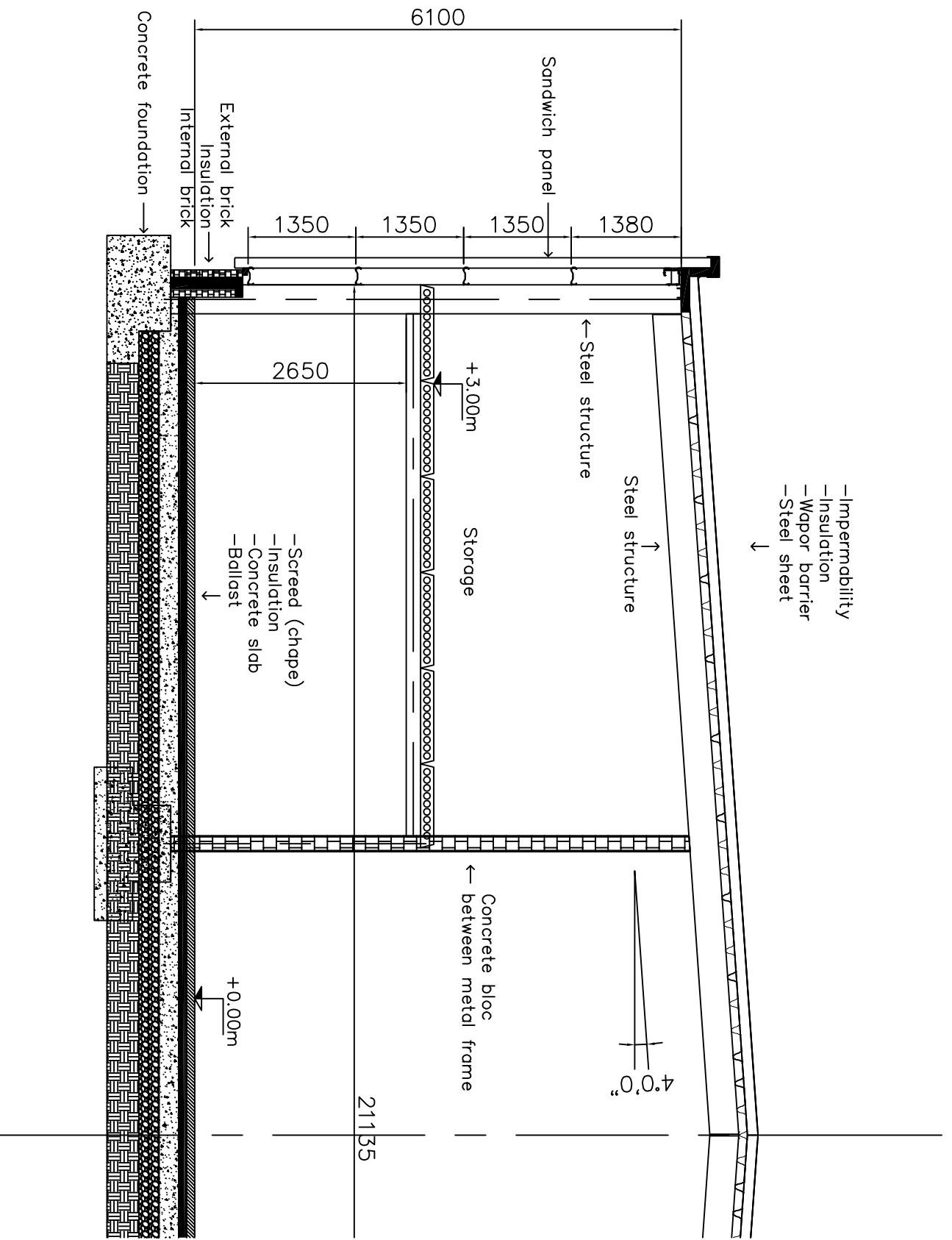

Ground floor

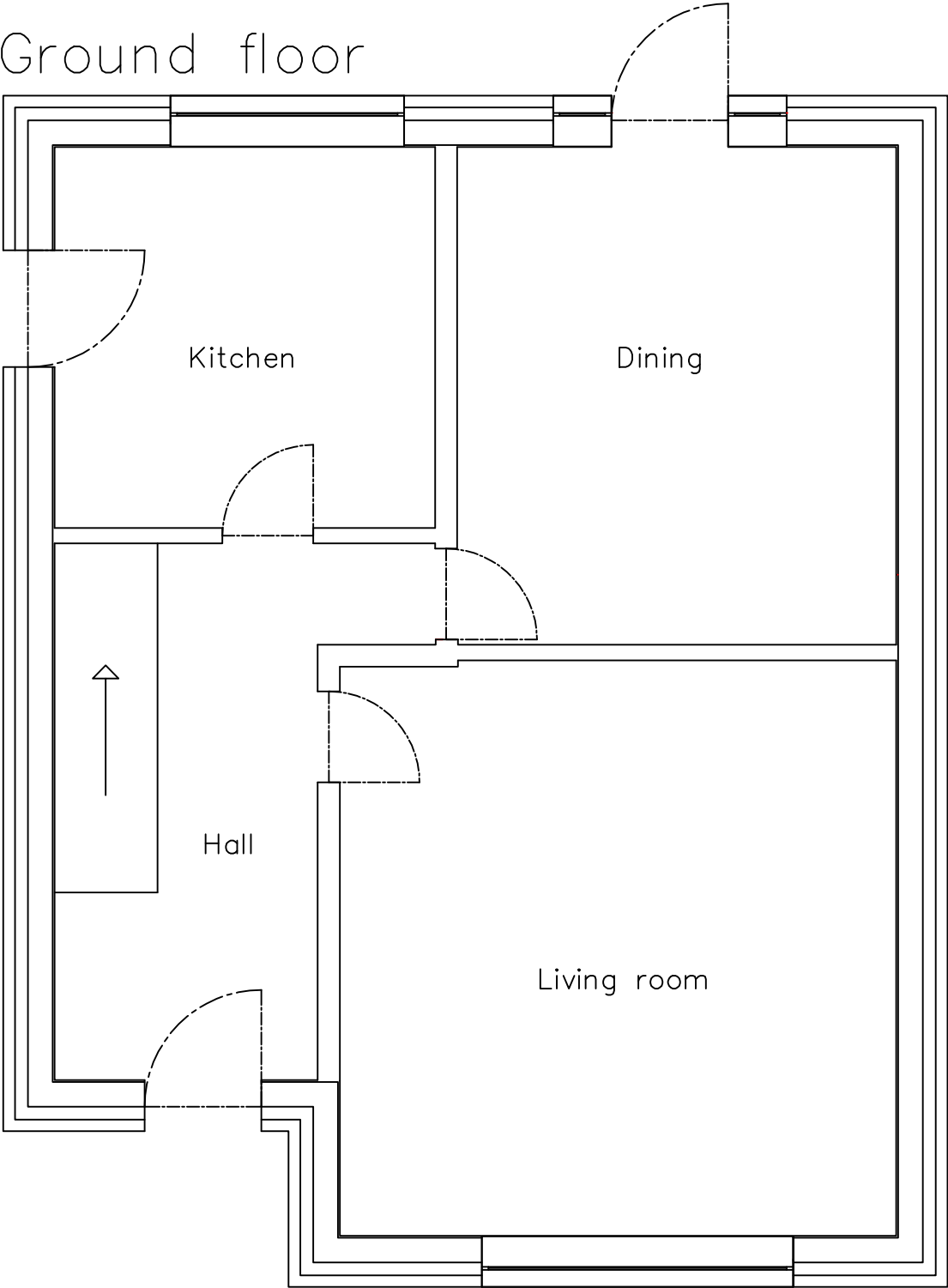

Scale 1:50

1st floor

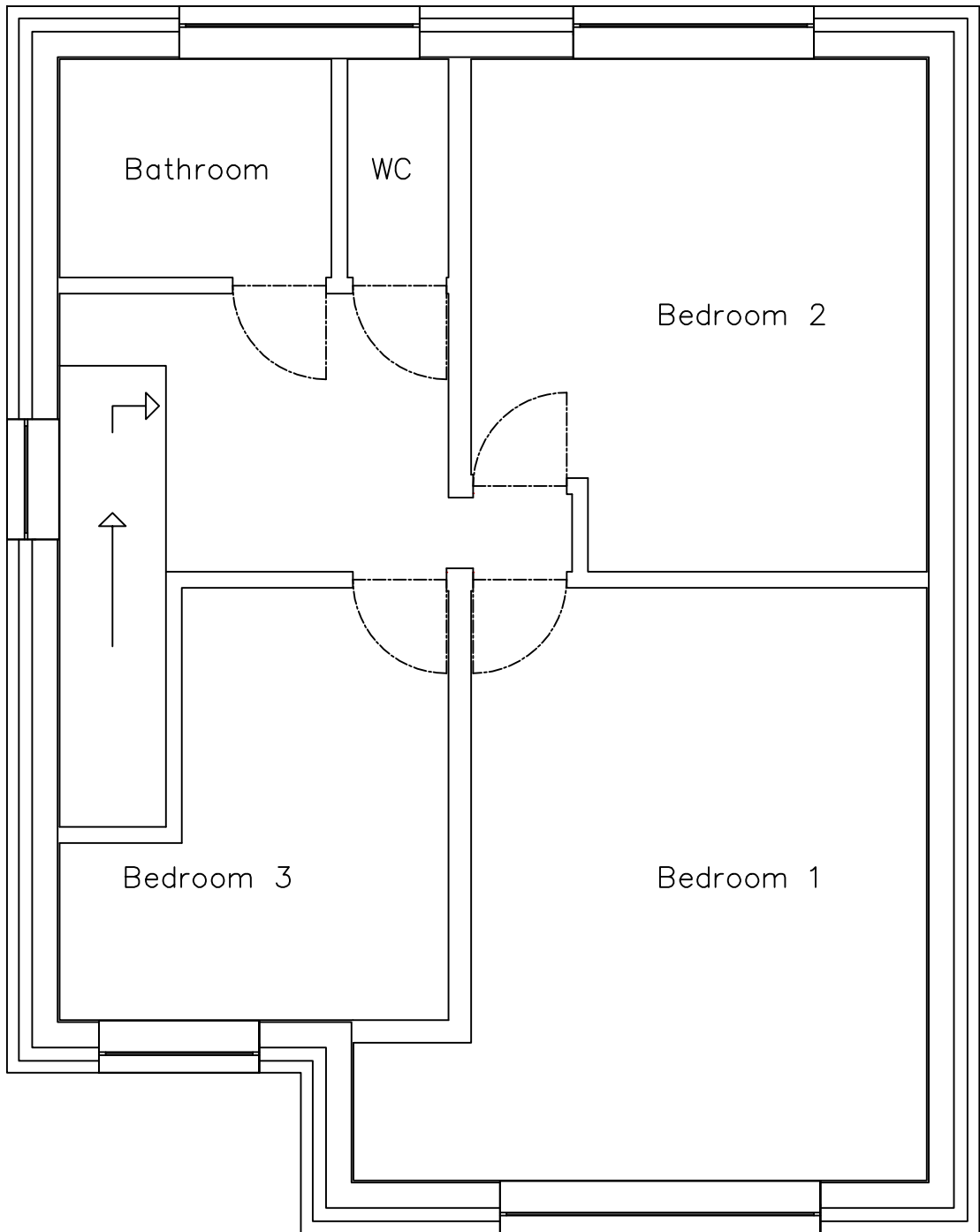

Scale 1:50

Attic

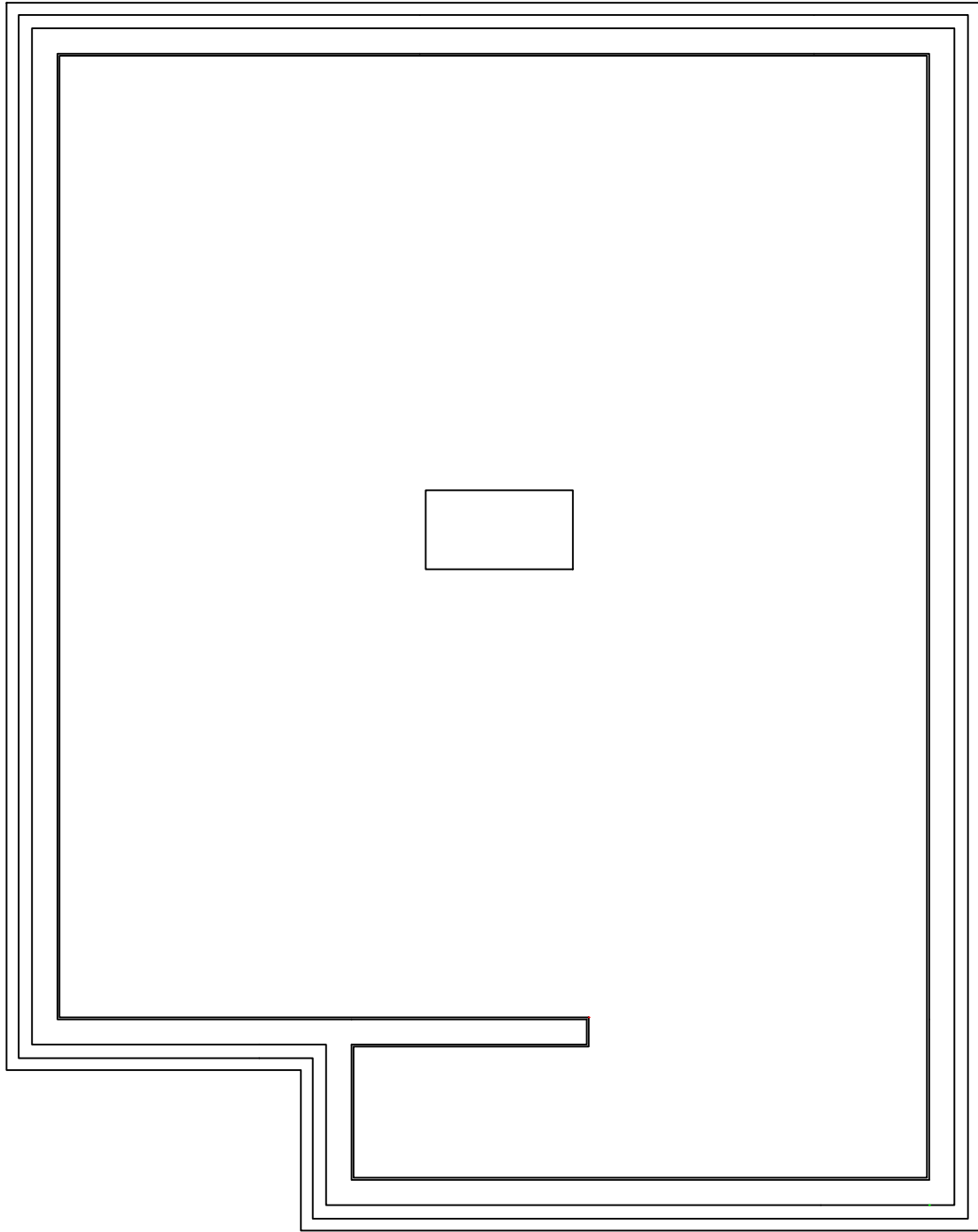

Scale 1:50

Front wall (East)

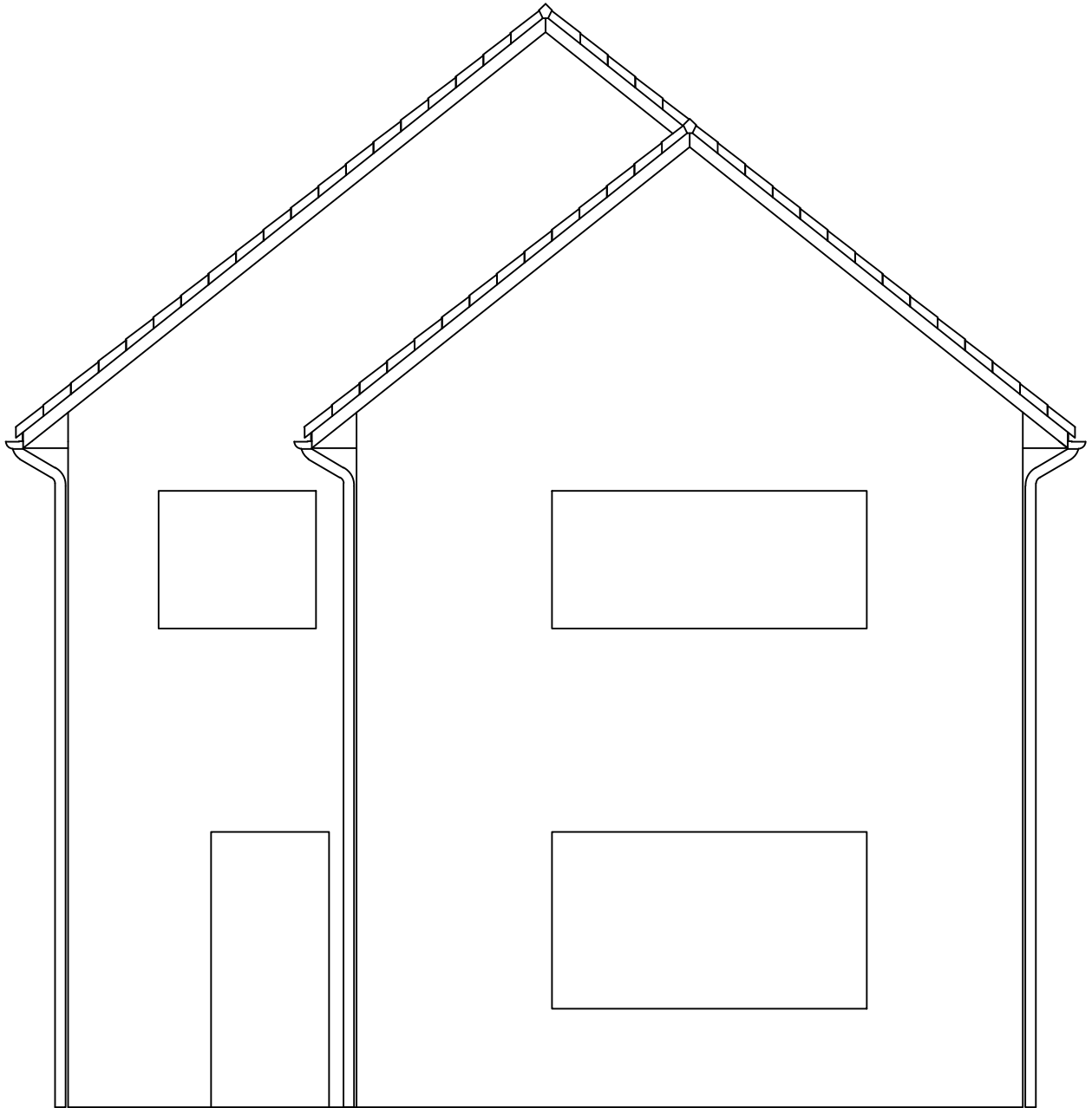

Scale 1:50

Rear wall (West)

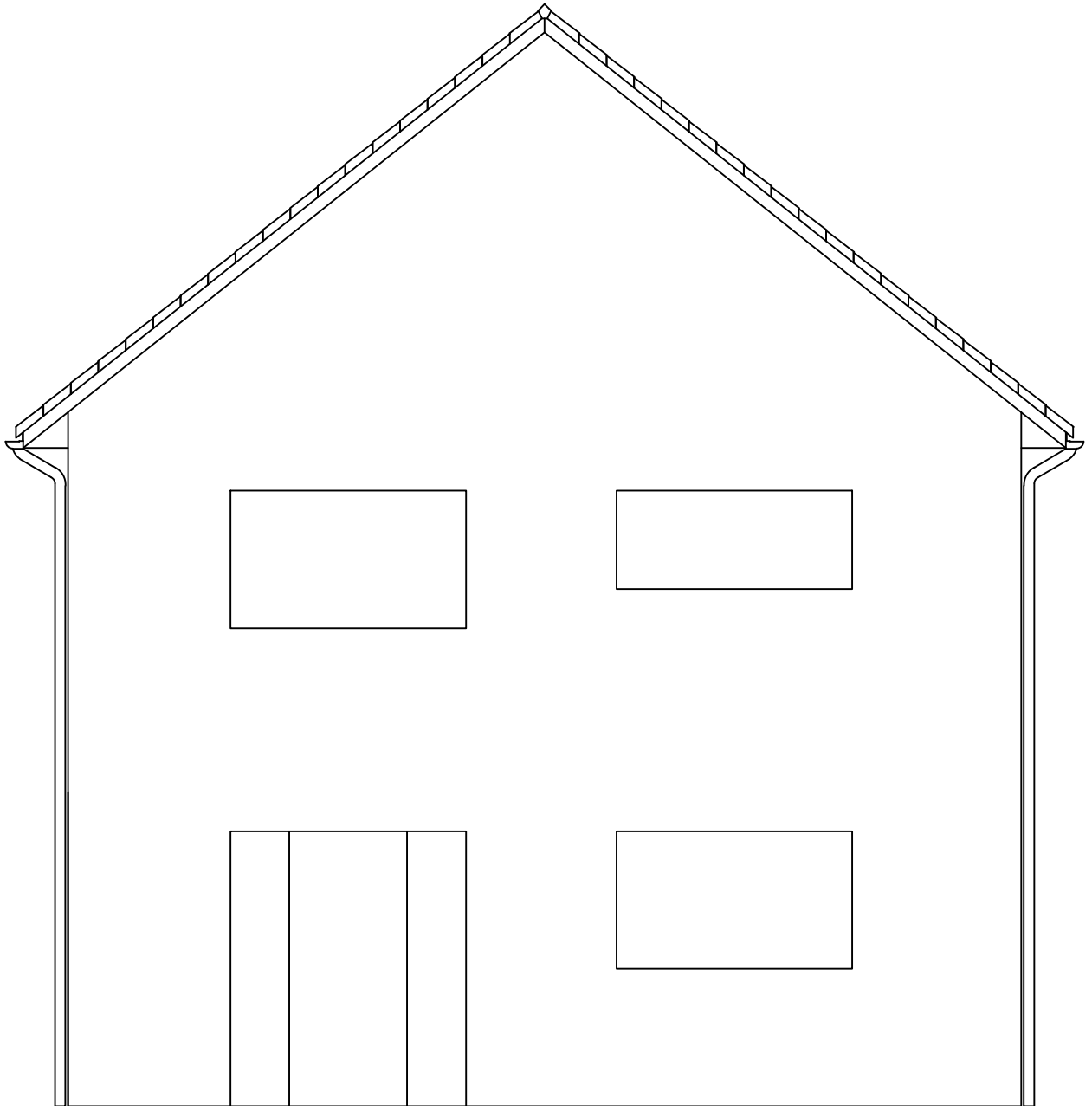

Scale 1:50

Side wall (South)

Scale 1:50

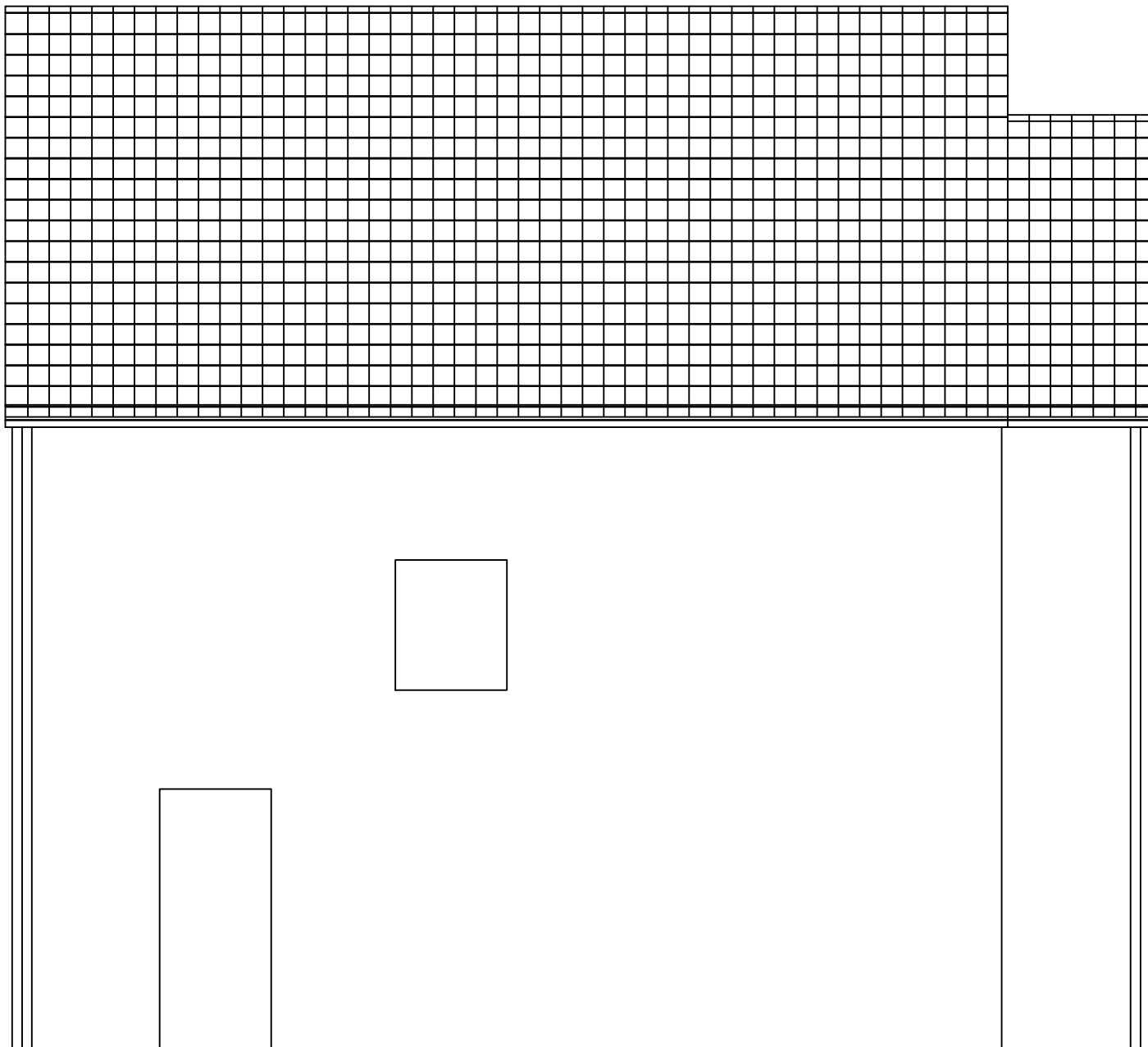

Side wall (North)

Scale 1:50

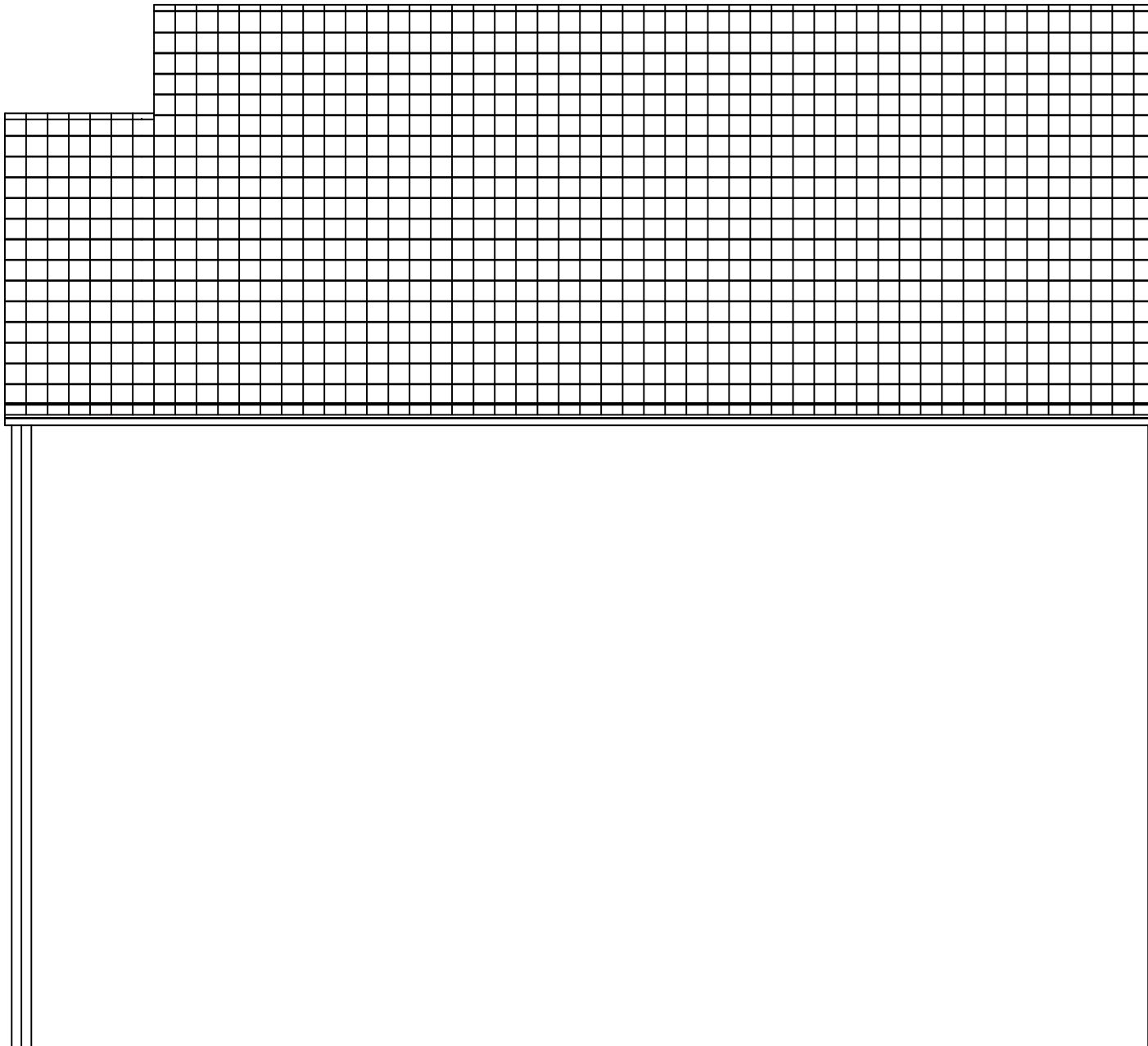

Appendix F. - *Detailed drawings part B*

PU renovation
U-value = 0.159W/m².K

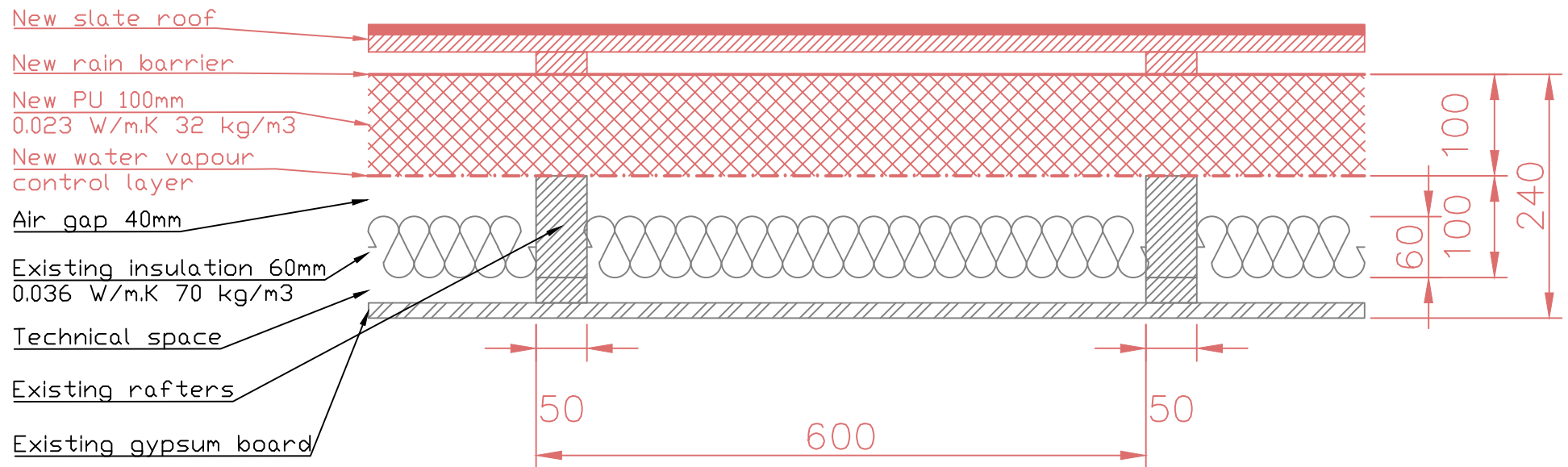

SW renovation
U-value = 0.158W/m².K

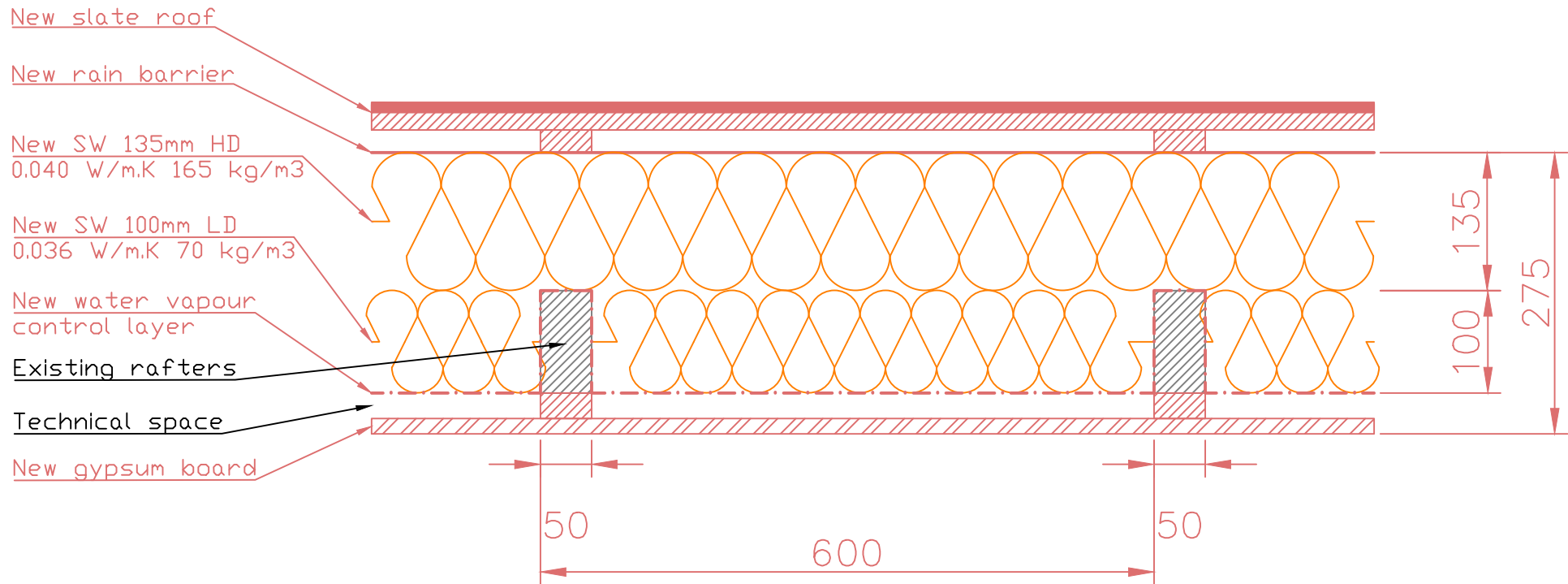

GW renovation
U-value = 0.161W/m².K

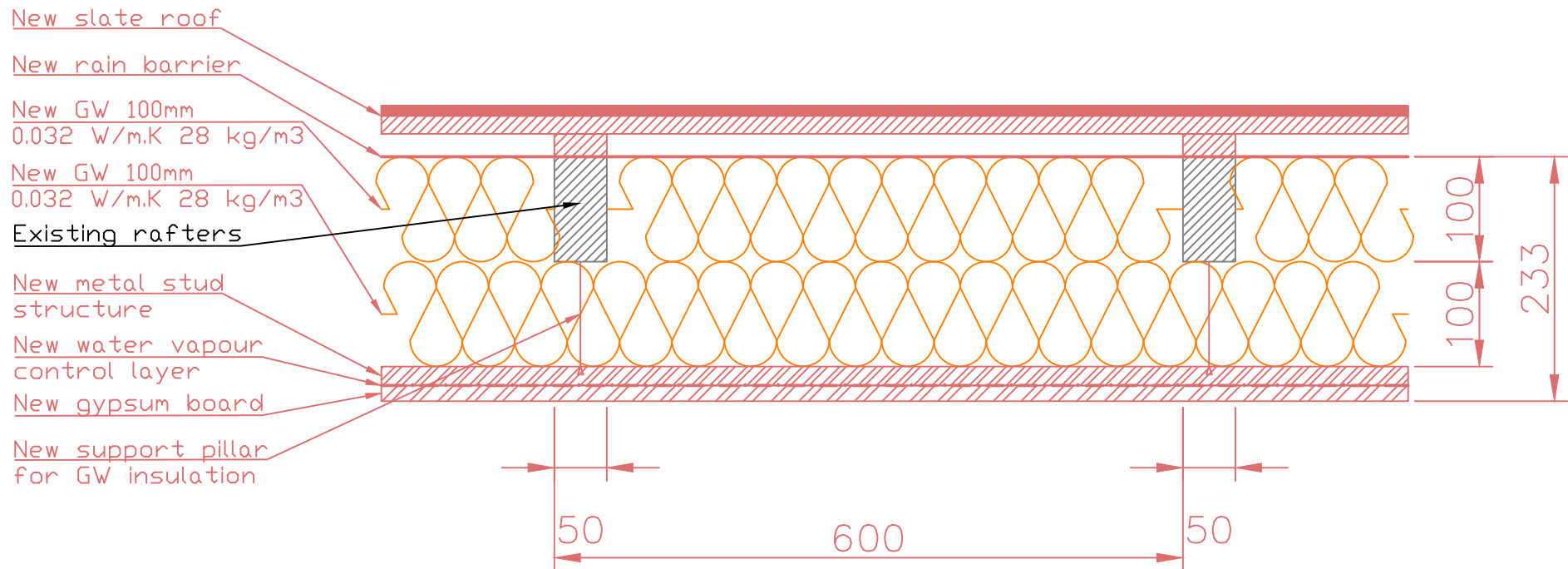

WF renovation
U-value = 0.160W/m².K

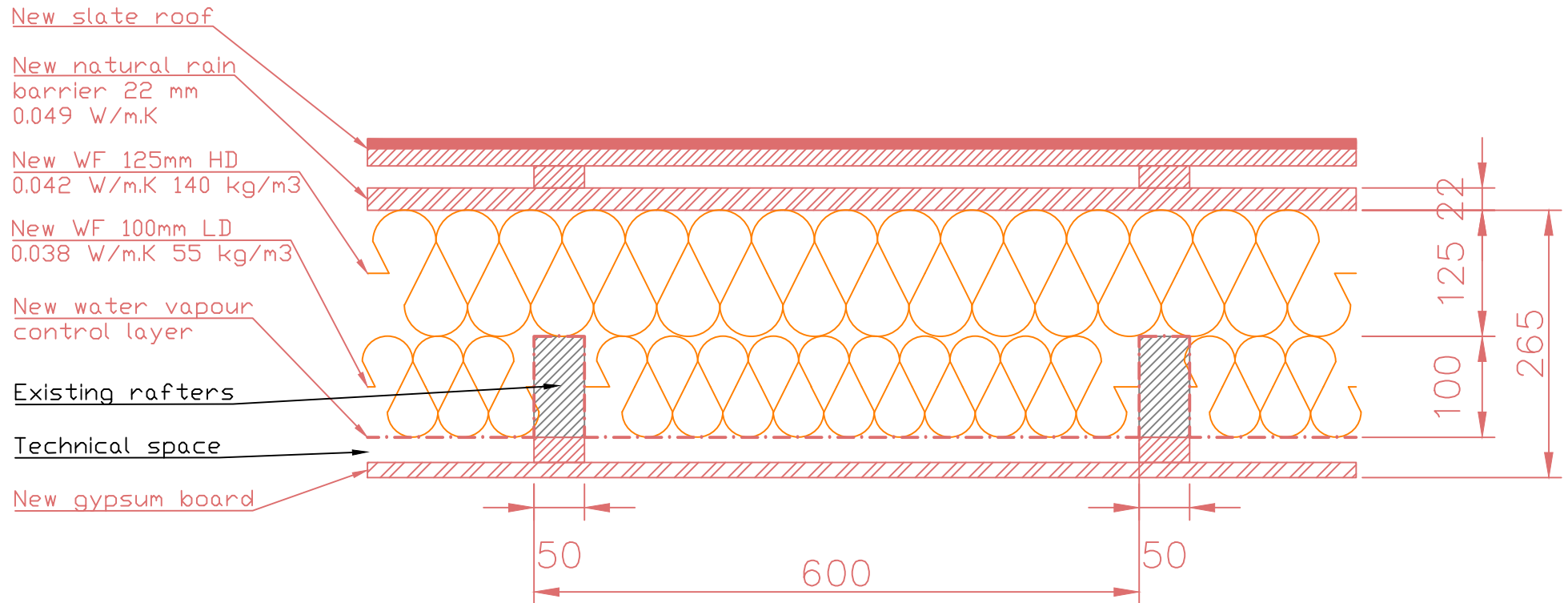

Appendix G. - *Building statics study* ***part A***

ETUDE PARAMETRIQUE D'UN BATIMENT EN STRUCTURE METALLIQUE

RAPPORT D'EXPERTISE



Code projet :
2012/270

Code document :

Date:
19.12.12

Rév

Auteur

Date

Modification

arcademe s.a. ▶ ingénieurs-conseils

12, rue du Cimetière
L8413 - Steinfort

T. +352 26 30 55 42
F. +352 26 30 55 43
E. ingenieurs@arcademe.lu

Matricule 2000-2226-759
T.V.A. intracommunautaire LU18453538
IBAN LU06 0019 3455 8381 9000

1.	INTRODUCTION	3
2.	DESCRIPTION DU BÂTIMENT ÉTUDIÉ	3
3.	OPTIONS DE CALCUL	3
4.	DONNÉES	3
5.	ETUDE DE LA NEIGE.....	4
6.	ETUDE DU VENT.....	4
7.	ETAT LIMITE ULTIME - COMBINAISON FONDAMENTALE.....	5
8.	DIMENSIONNEMENT DE LA ZONE DE STOCKAGE	6
9.	DIMENSIONNEMENT POTEAUX INTÉRIEURS - STOCKAGE	6
10.	DIMENSIONNEMENT DES LISSES DE BARDAGES	7
11.	DIMENSIONNEMENT DES POTELETS DE PIGNON.....	8
12.	DIMENSIONNEMENT DE LA TÔLE PROFILÉE (EN TOITURE).....	8
13.	DIMENSIONNEMENT DES PANNES	10
14.	DIMENSIONNEMENT DES TRAVERSEES	11
15.	DIMENSIONNEMENT DES POTEAUX EXTÉRIEURS.....	12
16.	DIMENSIONNEMENT DES POTEAUX CENTRAUX.....	13
17.	CONCLUSION ET OBSERVATION	13

□

1. Introduction

Dans cette synthèse de calcul, le travail demandé porte sur le pré-dimensionnement d'un bâtiment standard en structure métallique pour trois types de climats – Froid (Helsinki) – Moyen (Bruxelles) et – Méditerranéen (Rome).

Le but de ce travail est d'évaluer l'influence du poids de l'isolant utilisé sur le dimensionnement de la structure métallique.

Pour structurer la démarche de cette étude paramétrique, on va dans un premier temps dimensionner les parties qui sont indépendantes, c'est à dire celles qui ne sont pas influencées par le poids de l'isolant à savoir les poutres de la zone de stockage et les poteaux de la zone de stockage.

En suite, on va dimensionner les éléments secondaires (lisses de bardage et éléments de contreventements), puis les éléments porteurs principaux, les traverses et poteaux extérieurs.

2. Description du bâtiment étudié

Le bâtiment étudié est un bâtiment type retail en structure métallique.

Il est composé d'une structure double portique de 42,270m de large et de 54,270m de long.

Ces dimensions ont été fixées par hypothèses.

Notre étude a porté sur la moitié du bâtiment et les résultats ont été extrapolés à toute la structure à cause de la symétrie de certains éléments.

3. Options de calcul

L'étude de la structure métallique se limite en une Analyse élastique globale d'ordre 1.

La Rigidité réelle utilisée pour les assemblages classifiés comme rigides ou nominalement articulés.

4. Données

	Insulation material	Density [kg/m ³]	Lambda [W/m.K]	U Value [W/m ² .K]	Real Width [m]	Real U value [W/m ² .K]	Insulation weight [kg/m ²]	Inner + Outer metal sheet width [m]	Steel (sandwich panel only) weight [kg/m ²]	Total weight [kg/m ²]
External wall (Sandwich panels)	PU	45	0,023	0,17	0,135	0,166	6,1	0,0012	8,4	14,5
	SW	85	0,038	0,17	0,22	0,169	18,7	0,0012	8,4	27,1
Flat Roof	PU	32	0,023	0,16	0,145	0,155	4,6	-	-	4,6
	SW	150	0,04	0,16	0,25	0,1560	37,5	-	-	37,5

Tableau 1 : caractéristiques des isolants

5. Etude de la neige

L'Eurocode 1991-1-3 définit la manière de calculer les charges à prendre en considération lors du calcul d'une structure sous l'effet de la Neige.

D'une manière générale, la charge de neige (s) peut être calculée par la formule suivante:

$$S = \mu_i \cdot C_e \cdot C_t \cdot S_k$$

La charge de neige dépend du coefficient de forme μ , fonction de la pente du toit, du coefficient d'exposition au vent C_e , du coefficient thermique C_t ainsi que de la valeur caractéristique s_k , de la charge de neige sur le sol (kN/m^2).

La valeur caractéristique s_k est dépend l'altitude.

Pour les trois climats étudiés, les valeurs caractéristiques s_k sont reprises à l'**annexe 1** et dans le tableau ci-dessous.

ville	S_k (kN/m^2)
Bruxelles	0.80
Rome	1.15
Helsinki	3.00

Le coefficient de forme de la toiture pour notre projet $\mu=0.8$

Climat	Charge de Neige (kN/m^2)
Moyen (Belgique) Altitude >100m	0,64
Méditerranéen (Rome) Altitude <200m	0,92
Froid (Helsinki)	2,40

Tableau 2 : Charge de neige pour différents types de climats

6. Etude du vent

L'Eurocode 1991-1-4 définit la manière de calculer les charges à prendre en considération lors du calcul d'une structure sous l'effet du vent.

Ne sachant pas les caractéristiques du terrain ni l'altitude, nous avons pris les données de Bruxelles comme données de références.

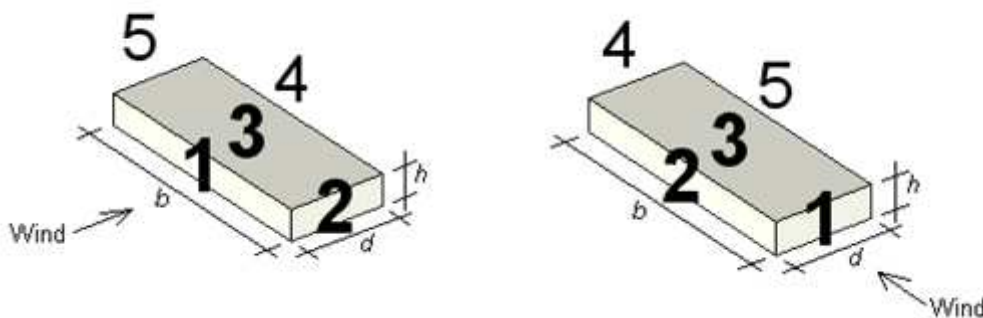

Datas :		
Fundamental basic wind velocity :		
vb,0	26	[m]
Terrain Category :		
cat	II	
Building dimensions :		
b	54,27	[m]
d	21,135	[m]
h	6,85	[m]
hdis	0	[m]
Roof angle :		
α	0	[°]
Wind direction :		
θ	-	[°]

Tableau 3 : Datas building

Results :											
Wind direction :		θ	0	[°]							
Zone	Surface [m ²]	Height [m]	qp [N/m ²]	cpe,10+	cpe,1+	cpe,10-	cpe,1-	cpi+	cpi-	Pressure [N/m ²]	Depression [N/m ²]
Mean on faces :											
-1-	370,6	6,9	894	0,71	1,00			-0,30		903	
-2-	144,8	6,9	894			-0,75	-0,93		0,20		-846
-3-	1143,4	6,9	894	0,14	0,14	-0,40	-0,58	-0,30	0,20	389	-536
-4-	370,6	6,9	894			-0,32	-0,32		0,20		-465

Wind direction :		θ	90	[°]							
Zone	Surface [m ²]	Height [m]	qp [N/m ²]	cpe,10+	cpe,1+	cpe,10-	cpe,1-	cpi+	cpi-	Pressure [N/m ²]	Depression [N/m ²]
Mean on faces :											
-1-	144,8	6,9	894	0,70	1,00			-0,30		894	
-2-	370,6	6,9	894			-0,60	-0,67		0,20		-712
-3-	1143,4	6,9	894	0,17	0,17	-0,28	-0,35	-0,30	0,20	425	-430
-4-	144,8	6,9	894			-0,30	-0,30		0,20		-447

Tableau 4 : Résultats de l'étude du vent

Cpe,1 = coefficient de pression extérieure pour une surface de 1m²

Cpe,10 = coefficient de pression extérieure pour une surface de 10m²

Cpi = coefficient de pression intérieure

7. Etat limite ultime - combinaison fondamentale

Pour le dimensionnement aux états limites, on examinera chaque fois le cas défavorable parmi les 3 cas repris dans le tableau ci-dessous.

	Nom	Poids propre	Charges permanentes	neige	Vent	Entretien/charges variables
1	ELU 1	0	1,00 x 1,35	1,00 x 1,50	0	0
2	ELU 2	0	1,00 x 1,35	0	1,00 x 1,50	0
3	ELU 3	0	1,00 x 1,35	0	0	1,00 x 1,50

Tableau 5 : Coefficients de combinaison de charges

8. Dimensionnement de la zone de stockage

Le plancher de la zone de stockage est composé d'un Hourdis, un béton de compression et d'une chape. Les hourdis reposent sur les poutres métalliques qui font l'objet de ce calcul.

Le choix du hourdis a fait l'objet d'une étude préliminaire qui n'est pas repris dans ce calcul, mais uniquement son poids.

On va aussi considérer une charge de cloisonnage de 150kg/m² car le bâtiment est toujours susceptible d'être réaffecté à une autre utilisation.

La fiche technique du hourdis se trouve à l'**annexe 2**.

La zone de stockage est calculée pour une charge d'exploitation de **500Kg/m²**.

Le poids des différents éléments est repris ci-dessous :

Charge

- Hourdis VS18	-	3,02 kN/m ² (fiche technique en annexe)
- Béton de compression (5cm)-	-	1,25 kN/m ²
- Chape (5cm)	-	1,00 kN/m ²
- Cloisons	-	1,50 kN/m ²
- Charge exploitation	-	5,00 kN/m ² - (EN 1991-1-1)

On va examiner 3 cas différents où l'entre axe des portiques est de 6,10m, 7m et 8m.

On va aussi limiter les déformations de la poutre à 1/300.

Les résultats détaillés sont dans la note de calcul en annexe.

Entre axe portiques	6.1m		7m		8m	
Msd (kNm)	621.69		713.42		815.34	
Msd réduit (kNm)	373.02		428.05		489.20	
Wpl (cm ³)	1825		2095		2394	
Choix Profilés	IPE 500	90.7 kg/m	IPE 500	90.7 kg/m	IPE 550	106.0 kg/m
	HEA 340	105.0 kg/m	HEA 360	112.0 kg/m	HEA 400	125.0 kg/m
	HEB 300	117.0 kg/m	HEB 320	127.0 kg/m	HEB 340	134.0 kg/m

9. Dimensionnement Poteaux intérieurs - Stockage

Les poutres métalliques supports de la zone de stockage, s'appuient sur les poteaux extérieurs et poteaux intérieurs. Ces poteaux intérieurs sont séparés par une maçonnerie.

L'effort sollicitant des poteaux intérieurs correspond aux valeurs de réactions d'appuis de la zone de stockage et du moment induit par l'encastrement poutre-colonne.

Les résultats détaillés sont dans la note de calcul en annexe.

Entre axe portiques	6.1m		7m		8m	
Choix Profilés	IPE 450	77.66 kg/m	IPE 500	90.7 kg/m	IPE 500	90.7 kg/m
	HEA 320	97.6 kg/m	HEA 340	105.0 kg/m	HEA 360	112.0 kg/m
	HEB 280	103.0 kg/m	HEB 300	117.0 kg/m	HEB 320	127.0 kg/m

10. Dimensionnement des lisses de bardages

Les lisses de bardage servent de support à l'enveloppe du bâtiment.

Cette enveloppe est constituée dans un cas de panneaux sandwich et dans un autre cas de laine de roche, dont les caractéristiques de ces deux matériaux sont reprises dans le tableau 1.

Les lisses sont soumises aux sollicitations suivantes :

- Vent	-	0,903kN/m ²
- cas 1 PU	-	0,150 kN/m ²
- cas 2 SW	-	0,271 kN/m ²

Les lisses sont sollicitées en flexion oblique, le vent agit dans le plan de l'axe y et les autres charges dans le plan perpendiculaire z.

On va considérer que sur la hauteur d'une façade, on a des lisses de bardage tous les 1,35m (largeur d'influence du vent et de l'isolant). Et on va limiter la flèche à l/300.

Sollicitation	kN/m ²	largeur d'influence (m)	Charge linéaire (kN/m)
vent	0,903	1,35	1,22
PU	0,15	1,35	0,20
SW	0,271	1,35	0,37

Entre axe portiques (m)	vent		
	6,1m	7m	8m
Msd (kNm)	8,51	11,20	14,63
Wply min (cm ²)	41,62	54,81	71,59
Iy min (cm ⁴)	515	778	1161
	PU		
Msd (kNm)	1,27	1,67	2,19
Wplz min (cm ²)	6,22	8,19	10,70
Iz min (cm ⁴)	85	129	193
	SW		
Msd (kNm)	2,30	3,03	3,95
Wplz min (cm ²)	11,24	14,80	19,34
Iz min (cm ⁴)	154	233	348

Pour dimensionner les lisses, on devra respecter 2 critères, (Wply min, Iy min)Vent et (Wplz min, Iz min) Isolant.

Pour les différents cas traités dans cette étude, on a les profils suivants :

Entre axe portiques	6.1m		7m		8m	
PU	IPE 180	18.8 kg/m	IPE 200	22.4 kg/m	IPE 220	26.2 kg/m
	HEA 120	19.9 kg/m	HEA 140	24.7 kg/m	HEA 160	30.4 kg/m
	HEB 120	26.7 kg/m	HEB 120	26.7 kg/m	HEB 140	33.7 kg/m
SW	IPE 220	26.2 kg/m	IPE 240	30.7 kg/m	IPE 270	36.1 kg/m
	HEA 120	19.9 kg/m	HEA 140	24.7 kg/m	HEA 160	30.4 kg/m
	HEB 120	26.7 kg/m	HEB 120	26.7 kg/m	HEB 140	33.7 kg/m

Le choix des profilés est le même pour les HEA ou HEB que ce soit pour l'isolant polyuréthane (PU) ou la laine de Roche (SW). Dans ce cas présent, le critère de déformation l/300 été plus déterminant.

11. Dimensionnement des Potelets de pignon

Les potelets de pignon sont sollicités par la force du vent, le poids de l'isolant ainsi que les lisses de bardages. On admettra que les lisses de bardages identiques à celles calculés au point précédent.

Vent = 0,895kN/m²

Isolant PU = 0,150 kN/m²

Isolant SW = 0,271 kN/m²

Lisse bardage = 19,9 kg/m (HEA 120)

L'entre axe des potelets de pignon est 5,30m

Hauteur moyenne des potelets = 6,5m

Les résultats des différents cas traités dans cette étude, se trouve dans le tableau ci-dessus. suivants :

PU		SW	
IPE 200	22.4 kg/m	IPE 200	22.4 kg/m
HEA 160	30.4 kg/m	HEA 160	30.4 kg/m
HEB 140	33.7 kg/m	HEB 140	33.7 kg/m

12. Dimensionnement de la tôle profilée (en toiture)

Dans cette partie on va étudier de l'influence du poids de l'isolant PU et SW sur le dimensionnement de la tôle profilée, pour déterminer l'entre distance maximum des portiques. La tôle est calculée comme une poutre sur 2travées.

La toiture considérée est composée de :

- support en tôles profilées (type Haironville ou équivalent) (**annexe 3**)
- pare vapeur PE (poids négligeable au m²)
- Isolant (type PU ou SW)
- Etanchéité bitumineuse bicouche (**annexe 4**)

Charges

	Bruxelles	Rome	Helsinki
	kN/m ²	kN/m ²	kN/m ²
Charges permanentes			
Etanchéité bicouche	0.0625	0.0625	0.0625
Isolation PU cas1	0.048	0.048	0.048
Isolation SW cas 2	0.375	0.375	0.375
Poids Tôle			
Surcharges variables			
Neige	0.64	0.92	2.40
Vent	-0.53	-0.53	-0.53
Entretien Toiture	0.80	0.80	0.80

Caractéristiques des Tôles profilés

Epaisseur tôle	MP100.275/3	MP106.250/3	MP135.310/3	MP150.280/3
mm	kg/m ²	kg/m ²	kg/m ²	kg/m ²
0.75	8.85	9.73	9.50	10.51
0.88	10.38	11.42	11.14	12.34
1.00	11.80	12.98	12.66	14.02

Cas de Bruxelles

Portée (Entre axe) max admissible [m]

Epaisseur Tôle	f _{max} =l/300					
	0,75mm		0,88mm		1,00mm	
Type de Profilé	PU	SW	PU	SW	PU	SW
MP100.275/3	5.50	4.50	5.75	5.25	6.00	5.50
MP106.250/3	6.00	5.25	6.25	5.75	6.50	6.00
MP135.310/3	6.25	5.25	7.00	6.25	7.00	6.25
MP150.280/3	7.50	6.25	8.00	7.25	8.00	7.50

Cas de Rome

Portée (Entre axe) max admissible [m]

Epaisseur Tôle	f _{max} =l/300					
	0,75mm		0,88mm		1,00mm	
Type de Profilé	PU	SW	PU	SW	PU	SW
MP100.275/3	4.75	4.00	5.25	4.75	5.50	5.00
MP106.250/3	5.25	4.50	5.75	5.25	6.00	5.50
MP135.310/3	5.25	4.50	6.25	5.50	6.75	6.25
MP150.280/3	6.25	5.50	7.25	6.50	7.50	7.00

Cas de Helsinki

Portée (Entre axe) max admissible [m]

Epaisseur Tôle	f _{max} =l/300					
	0,75mm		0,88mm		1,00mm	
Type de Profilé	PU	SW	PU	SW	PU	SW
MP100.275/3	-	-	3.25	3.00	3.75	3.50
MP106.250/3	-	-	3.75	3.50	4.00	3.75
MP135.310/3	-	-	4.25	4.00	4.25	4.00
MP150.280/3	-	-	4.75	4.50	5.25	5.00

Constatations

Lorsqu'on utilise une tôle de 0,75mm d'épaisseur avec le PU comme isolant on peut aller jusqu'à un entre axe de 7,5m pour Bruxelles, 6,25m pour Rome et pour Helsinki il n'y a pas de profilé qui répond aux critères de dimensionnement, dans ce cas on devra mettre des pannes en toiture.

Pour des tôles plus épaisses, on sait aller jusqu'à 8m d'entre axe à Bruxelles, 7,5m à Rome et 5,25m à Helsinki.

On remarque que l'utilisation de l'isolant SW a une incidence certaine sur le dimensionnement de la tôle mais pas seulement, la neige joue également un rôle prépondérant surtout dans le cas d'un climat froid (Helsinki).

La combinaison d'un isolant type SW et d'une neige caractéristique d'un climat froid, donne la combinaison la plus défavorable en terme de dimensionnement car, car pour cette combinaison on trouve une entre axe maximum de 5,25m et ce pour une tôle de 1mm d'épaisseur.

Si on veut garder l'entre axe maximum de 6,10m, on devra mettre dans ce cas des pannes, et donc une quantité d'acier supplémentaire.

Globalement l'utilisation du PU conduit à une économie de 10% du poids d'acier pour la sous structure.

13. Dimensionnement des Pannes

Pour le cas re Bruxelles et Rome on a montré au point précédent que l'on pouvait se passer des pannes car la tôle profilé rempli correctement la fonction de support de la toiture.

On va placer 5 pannes (voir croquis **annexe 5**), au niveau des nœuds supérieurs, qui serviront à transmettre uniquement horizontal l'effort de compression dû à la pression du vent sur les pignons. Pour Bruxelles et Rome on pourra mettre un des profilés suivants: HEA100, HEB100 ou IPE180.

Pour le cas de Helsinki, on va placer des pannes (croquis **annexe 6**).

Les charges agissant sur ces pannes et les profilés obtenus sont repris dans le tableau ci-dessous

	Helsinki	
	PU	SW
Etanchéité	0.0625	0.0625
Isolant	0.048	0.375
Tôle	0.0885	0.0885
Neige	2.40	2.40
	2.599	2.926

Cas isolant PU	Cas Helsinki		
	6m	7m	8m
choix profilé	HEA 220 50.5 kg/m	HEA 240 60.3 kg/m	HEA 260 68.2 kg/m
	HEB 180 51.2 kg/m	HEB 200 61.3 kg/m	HEB 220 71.5 kg/m
	IPE 270 36.2 kg/m	IPE 300 42.2 kg/m	IPE 330 49.1 kg/m

Cas isolant SW	6m		7m		8m	
choix profilé	HEA 220	50.5 kg/m	HEA 240	60.3 kg/m	HEA 260	68.2 kg/m
	HEB 200	61.3 kg/m	HEB 220	71.5 kg/m	HEB 240	83.2 kg/m
	IPE 300	42.2 kg/m	IPE 330	49.1 kg/m	IPE 360	57.1 kg/m

14. Dimensionnement des Traverses

Remarque

Etant donné que nous cherchons à étudier l'influence de l'isolation sur le dimensionnement de la structure portante, on va supposer que les tôles profilées ont une rigidité flexionnelle suffisante qui permet de moduler l'entre axe des portiques sans avoir besoin des mettre des pannes.

Pour Helsinki, cette hypothèse est en contradiction avec les observations du point précédent. Si on considère qu'on a des pannes (HEA 220) soit 50,5 kg/m sur une largeur de 5,245m, cela donne un poids surfacique de 0,0962 kN/m² (valeur inférieure au poids de la tôle considérée pour le dimensionnement 0,105kN/m²).

On va calculer les traverses en considérant le poids de la tôle profilée, qui est plus défavorable.

Détermination des Charges

	Bruxelles kN/m ²	Rome kN/m ²	Helsinki kN/m ²
Charges permanentes			
Etanchéité Bicouche	0.0625	0.0625	0.0625
Isolation PU	0.048	0.048	0.048
Isolation SW	0.375	0.375	0.375
Poids (moyen) Tôle 0,75mm	0.105	0.105	0,105
Pannes	-	-	-
Réserve	0.400	0.400	0.400

Surcharges variables

Neige	0.64	0.92	2.40
Entretien Toiture	0.80	0.80	0.80
Vent toiture	-0.53	-0.53	-0.53
Vent latéral gauche	0.905	0.905	0.905
Vent latéral droit	0.465	0.495	0.495

La combinaison de charge défavorable est celle qui reprend la charge due à l'entretien, pour le climat de Bruxelles et Rome, par contre pour Helsinki, la charge de neige est prépondérante.

Cas Bruxelles		Entre distance portique [m]					
Cas isolant PU		6m		7m		8m	
Msd max (kNm)		441.72		512.09		588.93	
Wpl (cm ³)		2162		2506		2882	
choix profilé	HEA 400	125,0 kg/m	HEA 400	125,0 kg/m	HEA 450	140,0 kg/m	
	HEB 340	134,0 kg/m	HEB 360	142,0 kg/m	HEB 400	155,0 kg/m	
Cas isolant SW		6m		7m		8m	
Msd max (kNm)		536.37		625.75		715.12	
Wpl (cm ³)		2625		3062		3500	
choix profilé	HEA 450	140,0 kg/m	HEA 450	140,0 kg/m	HEA 500	155,0 kg/m	
	HEB 360	142,0 kg/m	HEB 400	155,0 kg/m	HEB 450	171,0 kg/m	

Cas Helsinki		Entre distance portique [m]					
Cas isolant PU		6m		7m		8m	
Msd max (kNm)		961.79		1122.05		1282.35	
Wpl (cm ³)		4707		5491		6275	
choix profilé		HEA 600	178,0 kg/m	HEA 650	190,0 kg/m	HEA 700	204,0 kg/m
		HEB 500	187,0 kg/m	HEB 550	199,0 kg/m	HEB 600	212,0 kg/m
Cas isolant SW		6m		7m		8m	
Msd max (kNm)		1057.70		1234.00		1410.28	
Wpl (cm ³)		5176		6039		6901	
choix profilé		HEA 600	178,0 kg/m	HEA 650	190,0 kg/m	HEA 700	204,0 kg/m
		HEB 550	199,0 kg/m	HEB 600	212,0 kg/m	HEB 650	225,0 kg/m

Pour le cas de Bruxelles on remarque que l'utilisation du Pu entraine une économie moyenne de 10% du poids de l'acier par rapport au SW, alors que pour Helsinki le résultat reste inchangé pour les deux cas, mais cela pourrait dépendre de l'épaisseur de l'isolant à mettre en œuvre.

15. Dimensionnement des Poteaux Extérieurs

Les charges agissant sur les poteaux extérieurs des traverses, lisses de bardage et de la zone de stockage.

Les profils choisis sont repris dans le tableau ci-dessous :

Cas Bruxelles/Rome		Entre distance portique [m]					
Cas isolant PU		6m		7m		8m	
choix profilé		HEA 500	155 kg/m	HEA 550	166 kg/m	HEA 550	166 kg/m
		HEB 450	171 kg/m	HEB 500	187 kg/m	HEB 500	187 kg/m
Cas isolant SW		6m		7m		8m	
choix profilé		HEA 500	155 kg/m	HEA 550	166 kg/m	HEA 600	178 kg/m
		HEB 450	171 kg/m	HEB 500	187 kg/m	HEB 550	199 kg/m
Cas Helsinki		6m		7m		8m	
Cas isolant PU		6m		7m		8m	
choix profilé		HEA 600	178 kg/m	HEA 650	190 kg/m	HEA 700	204 kg/m
		HEB 550	199 kg/m	HEB 600	212 kg/m	HEB 650	225 kg/m
Cas isolant SW		6m		7m		8m	
choix profilé		HEA 600	178 kg/m	HEA 650	190 kg/m	HEA 800	224 kg/m
		HEB 550	199 kg/m	HEB 600	212 kg/m	HEB 650	225 kg/m

16. Dimensionnement des Poteaux centraux

Les poteaux intérieurs (centraux) supportent deux fois les réactions des traverses.
Le calcul détaillé de ces éléments se trouvent dans la note de calcul en annexe.

Cas Bruxelles/Rome		Entre distance portique [m]					
Cas isolant PU	6m		7m		8m		
choix profilé	HEA 200	42,3 kg/m	HEA 200	42,3 kg/m	HEA 220	50,5 kg/m	
	HEB 180	51,2 kg/m	HEB 180	51,2 kg/m	HEB 200	61,3 kg/m	

Cas isolant SW		Entre distance portique [m]					
Cas isolant SW	6m		7m		8m		
choix profilé	HEA 220	50,5 kg/m	HEA 220	50,5 kg/m	HEA 220	50,5 kg/m	
	HEB 180	51,2 kg/m	HEB 200	61,3 kg/m	HEB 200	61,3 kg/m	

Cas Helsinki		Entre distance portique [m]					
Cas isolant PU	6m		7m		8m		
choix profilé	HEA 240	60,3 kg/m	HEA 260	68,2 kg/m	HEA 280	76,4 kg/m	
	HEB 220	71,5 kg/m	HEB 240	83,2 kg/m	HEB 240	83,2 kg/m	

Cas isolant SW		Entre distance portique [m]					
Cas isolant SW	6m		7m		8m		
choix profilé	HEA 260	68,2 kg/m	HEA 260	68,2 kg/m	HEA 280	76,4 kg/m	
	HEB 220	71,5 kg/m	HEB 240	83,2 kg/m	HEB 260	93,0 kg/m	

17. Conclusion et Observation

Dans ce rapport nous avons montré pour chaque élément du portique, l'influence du poids de l'isolant (PU, SW) combiné aux autres actions sur le dimensionnement de la structure, et ce pour les trois types de climats.

Le dimensionnement des différents éléments a été fait sur base des profilés classiques (IPE, HEA, HEB). Il existe sur le marché d'autres types de profilés (Kingspan, Frisomat,...) qui permettent de gagner en poids d'acier et réduire le coût du bâtiment.

Les autres charges, telles que la neige, le vent, etc. sont des charges qui sont déterminées et calculées à partir des normes, on ne peut pas les modifier. Pour réduire le coût, on ne peut que jouer sur le poids et la composition de notre structure en utilisant des matériaux moins lourds mais qui répondent aux exigences en matière d'isolation thermique. Et le PU répond bien à ces exigences avec sa faible densité [45 kg/m³] et une petite valeur de Lambda [0,023 W/m.K].

Si on se limite uniquement à l'influence du poids de l'isolant, on remarque que pour un bâtiment de même dimension, le cas de Helsinki était plus défavorable car il nécessite des profils plus gros pour résister aux charges de neige qui sont beaucoup plus grandes qu'à Bruxelles ou Rome.

Les résultats obtenus pour les différents éléments montrent pour la sous structure de toiture et la structures (poteaux et traverses), on a globalement une économie de l'ordre de 10% du poids d'acier pour le cas de Bruxelles et Rome. Pour Helsinki, ce gain varie entre 0 et 10%, mais à réévaluer en fonction de l'épaisseur de l'isolant adaptée aux conditions climatiques.

English version

In this report we have illustrated for each element of the metal shed, the influence of the weight of the insulating material (PU, SW) as well as other effects on the structural design, for 3 different types of climates.

The structural design of the different elements was devised on the basis of the standard profiles (IPE,HEA,HEB). There are numerous other types of profiles (Kingspan, Frisomat, ...) that can be used to save on weight and to reduce the cost of building with steel.

Other weights like snow, winds etc... are determined and calculated on the basis of the approved standard; it cannot be changed.

There are other options which can help reduce cost. We can either reduce the weight, or change the components used in the structure by using lighter material that still need to meet the requirement for optimum thermal insulation. The PU meet those requirements. It has a low density [45 kg/m³] and its lambda value of 0.023W/mK.

We cannot only choose one variable. It is important to combine different variables in order to obtain a better result. Let take for instance Helsinki, if we only use one variable (the weight of the insulation material), we notice that for a building of the same size it is less attractive compared to Brussels or Rome.

The results obtained for the different elements to show the roof substructure and structures (Rafters and column), it has an overall saving of about 10% the weight of steel in the case of Brussels and Rome. For Helsinki, the saving is between 0 and 10%, but the thickness of the insulation will need to be reassess according to weather conditions.

Appendix H. - Construction costs Part A

H.1. Construction costs (building)

H.1.1. Cold climate

The following table indicates construction costs for the cold climate. Detailed costs are specified for the W-PU & R-PU scenario. For other scenarios, only costs that may change (steel structure and insulation costs) from the W-PU & R-PU scenario are listed in the tables below. All other elements remain unchanged.

Cold W-PU, R-PU			Construction costs [2012 discounted €]	
Excavation			13018	
Foundations		Bank - ballast 0/45 mm under floor slab (65 cm)	34891	
		Concrete foundation	19572	
		PE film	1220	
		Geotextile	2766	
External walls	Loadbearing external walls	Steel structure	37589	
		External doors and windows	36771	
		Window-door (front entry)	5464	
		Insulated metal doors (6 doors)	7562	
		Sectional door	13111	
	Cladding units	PU Sandwich panel	65926	
		Internal concrete blocks (9 cm)	14578	
		PU insulation (13.5 cm)	6829	
		External brick (9 cm)	11756	
		Concrete sill (9*25cm)	4499	
	Sandwich panel bindings	23131		
Internal walls	Loadbearing internal walls	Steel frame	14023	
		Concrete blocks between metal frame - 20 cm	22788	
	Non-loadbearing internal walls	Concrete blocks - 14 cm	20824	
	Internal doors and windows	Internal wood doors (10)	9142	
	Internal linings (of internal walls)	Plaster boards - 15 mm	28165	
		Stoneware wall tiles (WC)	2564	
Floors and ceilings	Floor structures	Reinforced concrete slab ground floor (25 cm)	274713	
		Steel frame	9218	
		2 metal staircases	2107	
		1st floor hollow core slab h=16 cm	27494	
	Floorings	Concrete screed 10 cm	47277	
		PU insulation - 120 mm	98768	
		Stoneware floor tiles (all surfaces except technical and storage rooms)	271309	
		Compression slab - 5 cm	4723	
		Concrete screed - 5 cm	1181	
	Ceiling linings	Ceiling linings	13481	
		Metal studs for ceiling linings	3370	
	Roofs	Roof structure	Steel frame	146735
		Roof coverings	Waterproofing membrane (bitumen)	98017
			PU insulation - 330 mm	225921
Vapour-barrier			15866	
Roofing sheet trapezoidal			44738	
Roofs, other items		Rainwater gutter	1893	
		Rainwater pipe (8)	760	
Total construction costs (building)			1683761	

Cold W-PU, R-EPS			Construction costs [2012 discounted €]
External walls	Loadbearing external walls	Steel structure	37589
	Cladding units	SW Sandwich panel	65926
		PU insulation (13.5 cm)	6829
		Sandwich panel bindings	23131
Internal walls	Loadbearing internal walls	Steel frame	14023
Floors and ceilings	Floor structures	Steel frame	9218
Roofs	Roof structure	Steel frame	146735
	Roof coverings	EPS insulation - 500 mm	170579
		Roofing sheet trapezoidal	44738
Total construction costs (building)			1628419

Cold W-SW, R-SW			Construction costs [2012 discounted €]
External walls	Loadbearing external walls	Steel structure	37589
	Cladding units	SW Sandwich panel	81649
		PU insulation (13.5 cm)	6829
		Sandwich panel bindings	32236
Internal walls	Loadbearing internal walls	Steel frame	14796
Floors and ceilings	Floor structures	Steel frame	9218
Roofs	Roof structure	Steel frame	151485
	Roof coverings	SW insulation - 570 mm	219371
		Roofing sheet trapezoidal	50828
Total construction costs (building)			1713651

Cold W-SW, R-EPS			Construction costs [2012 discounted €]
External walls	Loadbearing external walls	Steel structure	37589
	Cladding units	SW Sandwich panel	81649
		PU insulation (13.5 cm)	6829
		Sandwich panel bindings	32236
Internal walls	Loadbearing internal walls	Steel frame	14023
Floors and ceilings	Floor structures	Steel frame	9218
Roofs	Roof structure	Steel frame	146735
	Roof coverings	EPS insulation - 500 mm	170579
		Roofing sheet trapezoidal	44738
Total construction costs (building)			1653247

H.1.2. Moderate climate

The following table indicates construction costs for the moderate climate. Costs are details in the same way as for cold climate. Detailed costs are specified for the W-PU & R-PU scenario. For other scenarios, only costs that may change (steel structure and insulation costs) from the W-PU & R-PU scenario are listed in the tables below. All other elements remain unchanged.

Moderate W-PU, R-PU

Moderate W-PU, R-PU			Construction costs [2012 discounted €]	
Excavation			11376	
Foundations		Bank - ballast 0/45 mm under floor slab (65 cm)	30491	
		Concrete foundation	17103	
		PE film	1067	
		Geotextile	2417	
External walls	Loadbearing external walls	Steel structure	28920	
		External doors and windows	Front band of window with metal frame	32134
		Window-door (front entry)	4774	
		Insulated metal doors (6 doors)	6609	
		Sectional door	11457	
	Cladding units	PU Sandwich panel	57612	
		Internal concrete blocks (9 cm)	12739	
		PU insulation (13.5 cm)	5968	
		External brick (9 cm)	10274	
		Concrete sill (9*25cm)	3932	
		Sandwich panel bindings	20214	
Internal walls	Loadbearing internal walls	Steel frame	10718	
		Concrete blocks between metal frame - 20 cm	19914	
	Non-loadbearing internal walls	Concrete blocks - 14 cm	18198	
	Internal doors and windows	Internal wood doors (10)	7989	
	Internal linings (of internal walls)	Plaster boards - 15 mm	24613	
		Stoneware wall tiles (WC)	2240	
	Floors and ceilings	Floor structures	Reinforced concrete slab ground floor (25 cm)	240067
Steel frame			8056	
2 metal staircases			1841	
1st floor hollow core slab h=16 cm			24027	
Floorings		Concrete screed 10 cm	41315	
		PU insulation - 120 mm	86312	
		Stoneware floor tiles (all surfaces except technical and storage rooms)	237092	
		Compression slab - 5 cm	4127	
		Concrete screed - 5 cm	1032	
		Ceiling linings	Ceiling linings	11781
Metal studs for ceiling linings			2945	
Roofs		Roof structure	Steel frame	79113
		Roof coverings	Waterproofing membrane (bitumen)	85656
			PU insulation - 145 mm	110453
	Vapour-barrier		13865	
	Roofing sheet trapezoidal		30098	
	Roofs, other items	Rainwater gutter	1654	
		Rainwater pipe (8)	665	
Total construction costs (building)			1320857	

Moderate W-PU, R-EPS			Construction costs [2012 discounted €]
External walls	Loadbearing external walls	Steel structure	28920
	Cladding units	SW Sandwich panel	57612
		PU insulation (13,5 cm)	5968
		Sandwich panel bindings	20214
Internal walls	Loadbearing internal walls	Steel frame	10718
Floors and ceilings	Floor structures	Steel frame	8056
Roofs	Roof structure	Steel frame	79113
	Roof coverings	EPS insulation - 220 mm	84642
		Roofing sheet trapezoidal	30098
Total construction costs (building)			1295045

Moderate W-SW, R-SW			Construction costs [2012 discounted €]
External walls	Loadbearing external walls	Steel structure	28920
	Cladding units	SW Sandwich panel	71352
		PU insulation (13,5 cm)	5968
		Sandwich panel bindings	28170
Internal walls	Loadbearing internal walls	Steel frame	11418
Floors and ceilings	Floor structures	Steel frame	8056
Roofs	Roof structure	Steel frame	87849
	Roof coverings	SW insulation - 250 mm	120980
		Roofing sheet trapezoidal	33298
Total construction costs (building)			1365715

Moderate W-SW, R-EPS			Construction costs [2012 discounted €]
External walls	Loadbearing external walls	Steel structure	28920
	Cladding units	SW Sandwich panel	71352
		PU insulation (13,5 cm)	5968
		Sandwich panel bindings	28170
Internal walls	Loadbearing internal walls	Steel frame	10718
Floors and ceilings	Floor structures	Steel frame	8056
Roofs	Roof structure	Steel frame	79113
	Roof coverings	EPS insulation - 220 mm	84642
		Roofing sheet trapezoidal	30098
Total construction costs (building)			1316741

H.1.3. Mediterranean climate

The following table indicates construction costs for the moderate climate. Costs are details in the same way as for cold climate. Detailed costs are specified for the W-PU & R-PU scenario. For other scenarios, only costs that may change (steel structure and insulation costs) from the W-PU & R-PU scenario are listed in the tables below. All other elements remain unchanged.

Mediterranean W-PU, R-PU			Construction costs [2012 discounted €]	
Excavation			10272	
Foundations		Bank - ballast 0/45 mm under floor slab (65 cm)	27531	
		Concrete foundation	15443	
		PE film	963	
		Geotextile	2183	
External walls	Loadbearing external walls	Steel structure	26113	
		Front band of window with metal frame	29015	
	External doors and windows	Window-door (front entry)	4311	
		Insulated metal doors (6 doors)	5967	
		Sectional door	10345	
		Cladding units	PU Sandwich panel	47153
		Internal concrete blocks (9 cm)	11503	
		PU insulation (13.5 cm)	4437	
		External brick (9 cm)	9276	
		Concrete sill (9*25cm)	3550	
		Sandwich panel bindings	18252	
	Internal walls	Loadbearing internal walls	Steel frame	9677
Concrete blocks between metal frame - 20 cm			17981	
Non-loadbearing internal walls		Concrete blocks - 14 cm	16431	
		Internal doors and windows	Internal wood doors (10)	7214
Internal linings (of internal walls)		Plaster boards - 15 mm	22224	
		Stoneware wall tiles (WC)	2023	
Floors and ceilings		Floor structures	Reinforced concrete slab ground floor (25 cm)	216766
			Steel frame	7274
			2 metal staircases	1662
			1st floor hollow core slab h=16 cm	21695
	Floorings	Concrete screed 10 cm	37305	
		PU insulation - 120 mm	52740	
		Stoneware floor tiles (all surfaces except technical and storage rooms)	214080	
		Compression slab - 5 cm	3726	
		Concrete screed - 5 cm	932	
	Ceiling linings	Ceiling linings	10638	
		Metal studs for ceiling linings	2659	
	Roofs	Roof structure	Steel frame	71434
		Roof coverings	Waterproofing membrane (bitumen)	77342
PU insulation - 130 mm			93177	
Vapour-barrier			12519	
Roofing sheet trapezoidal			27177	
Roofs, other items		Rainwater gutter	1494	
		Rainwater pipe (8)	600	
		Total construction costs (building)	1155082	

Mediterranean W-PU, R-EPS			Construction costs [2012 discounted €]
External walls	Loadbearing external walls	Steel structure	26113
	Cladding units	PU Sandwich panel	47153
		PU insulation (13.5 cm)	4437
		Sandwich panel bindings	18252
Internal walls	Loadbearing internal walls	Steel frame	9677
Floors and ceilings	Floor structures	Steel frame	7274
Roofs	Roof structure	Steel frame	71434
	Roof coverings	EPS insulation - 195 mm	71417
		Roofing sheet trapezoidal	27177
		Total construction costs (building)	1133322

Mediterranean W-SW, R-SW			Construction costs [2012 discounted €]
External walls	Loadbearing external walls	Steel structure	26113
	Cladding units	SW Sandwich panel	59436
		PU insulation (13.5 cm)	4437
		Sandwich panel bindings	25436
Internal walls	Loadbearing internal walls	Steel frame	10310
Floors and ceilings	Floor structures	Steel frame	7274
Roofs	Roof structure	Steel frame	79322
	Roof coverings	SW insulation - 220 mm	103228
		Roofing sheet trapezoidal	30066
		Total construction costs (building)	1196010

Mediterranean W-SW, R-EPS			Construction costs [2012 discounted €]
External walls	Loadbearing external walls	Steel structure	26113
	Cladding units	SW Sandwich panel	59436
		PU insulation (13.5 cm)	4437
		Sandwich panel bindings	25436
Internal walls	Loadbearing internal walls	Steel frame	9677
Floors and ceilings	Floor structures	Steel frame	7274
Roofs	Roof structure	Steel frame	71434
	Roof coverings	EPS insulation - 195 mm	71417
		Roofing sheet trapezoidal	27177
		Total construction costs (building)	1152790

H.2. Construction costs (equipments)

H.2.1. Cold climate

The following table indicates equipments costs for the cold climate. Equipments costs are the same for each insulation materials but differ with the climate considered due to the regional factor applied.

Cold			Construction costs [2012 discounted €]
Sewerage, water and gas systems	Sewerage systems	PVC DN 50 pipes	17
		PVC DN 110 pipes	220
	Water supply systems	Ceramic toilet bowl (4)	1563
		Mixer tap	57
		Ceramic washbasins (2)	699
		Mixer tap (1 per washbasin)	175
		PEHD DN20 pipes	164
		Hot water pipes insulation (Armaflex 2.5 cm)	234
		Other accessories (valves, pressure limiter, etc.)	6265
	Heat supply systems	Heat generators	Condensing gas boiler
Boiler regulation with probe			7660
DHW Cylinder 160L			2779
Heat distribution networks		Steel pipes 1 in	4323
		Steel pipes 2 in	15720
		Steel pipes 4 in	5633
		Steel pipes insulation (Armaflex 2.5 cm)	1234
		Steel pipes insulation (Armaflex 3.2 cm)	12260
		Steel pipes insulation (Armaflex 4.0 cm)	10652
		Regulation pump	5347
		Expansion tank 8L	79
Space heating		Other (header, small pipes, etc.)	11748
		Fan coils	62937
Air treatment systems		Monobloc chiller	90744
		Plate heat recovery	15251
		Heating coil	15251
		Cooling coil	15251
		Air transmission: small air ducts	13553
		Air transmission: medium air ducts	2997
		Air transmission: big air ducts	323
		Other (header, small pipes, etc.)	11748
Power installations		Wire 2.5 mm2 Ho7VU25	56
		Wire 6 mm2 Ho7VR6	990
		Bare wire 35 mm2	140
		Electrical conduit ICTA 25mm	832
		Lighting 2*58W	34192
		Total	381734

H.2.2. Moderate climate

The following table indicates equipments costs for the moderate climate.

Moderate W-PU, R-PU

Moderate W-PU, R-PU			Construction costs [2012 discounted €]		
Sewerage, water and gas systems	Sewerage systems	PVC DN 50 pipes	15		
		PVC DN 110 pipes	193		
	Water supply systems	Ceramic toilet bowl (4)	1366		
		Mixer tap	50		
		Ceramic washbasins (2)	611		
		Mixer tap (1 per washbasin)	153		
		PEHD DN20 pipes	143		
		Hot water pipes insulation (Armaflex 2.5 cm)	204		
		Other accessories (valves, pressure limiter, etc.)	5475		
		Heat supply systems	Heat generators	Condensing gas boiler	23282
			Heat distribution networks	Boiler regulation with probe	5821
				DHW Cylinder 160L	2428
Steel pipes 1 in	3778				
Steel pipes 2 in	13738				
Steel pipes 4 in	4923				
Steel pipes insulation (Armaflex 2.5 cm)	1078				
Steel pipes insulation (Armaflex 3.2 cm)	10714				
Steel pipes insulation (Armaflex 4.0 cm)	9309				
Regulation pump	4673				
Expansion tank 8L	69				
Other (header, small pipes, etc.)	10266				
Space heating	Fan coils			55000	
Air treatment systems				Monobloc chiller	97500
		Plate heat recovery	13328		
		Heating coil	13328		
		Cooling coil	13328		
		Air transmission: small air ducts	11843		
		Air transmission: medium air ducts	2619		
		Air transmission: big air ducts	282		
		Other (header, small pipes, etc.)	10266		
Power installations		Wire 2.5 mm ² H07VU25	49		
		Wire 6 mm ² H07VR6	865		
		Bare wire 35 mm ²	122		
		Electrical conduit ICTA 25mm	727		
		Lighting 2*58W	29880		
		Total	347426		

H.2.3. Mediterranean climate

The following table indicates equipments costs for the Mediterranean climate.

Mediterranean			Construction costs [2012 discounted €]	
Sewerage, water and gas systems	Sewerage systems	PVC DN 50 pipes	14	
		PVC DN 110 pipes	174	
	Water supply systems	Ceramic toilet bowl (4)	1234	
		Mixer tap	45	
		Ceramic washbasins (2)	552	
		Mixer tap (1 per washbasin)	138	
		PEHD DN20 pipes	129	
		Hot water pipes insulation (Armaflex 2.5 cm)	184	
		Other accessories (valves, pressure limiter, etc.)	4944	
	Heat supply systems	Heat generators	Condensing gas boiler	17869
Boiler regulation with probe			4467	
DHW Cylinder 160L			2193	
Heat distribution networks		Steel pipes 1 in	3411	
		Steel pipes 2 in	12404	
		Steel pipes 4 in	4445	
		Steel pipes insulation (Armaflex 2.5 cm)	974	
		Steel pipes insulation (Armaflex 3.2 cm)	9674	
		Steel pipes insulation (Armaflex 4.0 cm)	8405	
		Regulation pump	4219	
		Expansion tank 8L	63	
		Other (header, small pipes, etc.)	9270	
		Space heating	Fan coils	49662
Air treatment systems			Monobloc chiller	114330
			Plate heat recovery	12034
			Heating coil	12034
			Cooling coil	12034
	Air transmission: small air ducts		10694	
	Air transmission: medium air ducts		2365	
	Air transmission: big air ducts		255	
	Other (header, small pipes, etc.)		9270	
Power installations		Wire 2.5 mm2 Ho7VU25	44	
		Wire 6 mm2 Ho7VR6	781	
		Bare wire 35 mm2	111	
		Electrical conduit ICTA 25mm	657	
		Lighting 2*58W	26980	
		Total	336055	

Appendix I. - Maintenance costs part A

I.1. Shell, core & finishing

	Maintenance costs - Shell core & finishing			
	Effort on servicing [%]	Effort on repairs [%]	2012 maintenance costs [2012 discounted €]	Life cycle cost [2012 discounted €]
Cold W-PU, R-PU	0.1%	1.0%	18521	586836
Cold W-PU, R-EPS	0.1%	1.0%	17913	567548
Cold W-SW, R-SW	0.1%	1.0%	18850	597253
Cold W-SW, R-EPS	0.1%	1.0%	18186	576201
Moder W-PU, R-PU	0.1%	1.0%	14529	460354
Moder W-PU, R-EPS	0.1%	1.0%	14245	451358
Moder W-SW, R-SW	0.1%	1.0%	15023	475988
Moder W-SW, R-EPS	0.1%	1.0%	14484	458919
Mediterranean W-PU, R-PU	0.1%	1.0%	12706	402577
Mediterranean W-PU, R-EPS	0.1%	1.0%	12467	394993
Mediterranean W-SW, R-SW	0.1%	1.0%	13156	416841
Mediterranean W-SW, R-EPS	0.1%	1.0%	12681	401778

I.2. Equipments

	Maintenance costs - Equipments			
	Effort on servicing [%]	Effort on repairs [%]	Equipments costs [2012 discounted €]	2012 maintenance costs [2012 discounted €]
Cold climate				
PVC DN 50 pipes	0.70%	0.55%	17	0
PVC DN 110 pipes	0.70%	0.55%	220	3
Ceramic toilet bowl (4)	0.70%	0.55%	1563	20
Mixer tap	0.00%	1.00%	57	1
Ceramic washbasins (2)	0.70%	0.55%	699	9
Mixer tap (1 per washbasin)	0.00%	1.00%	175	2
PEHD DN20 pipes	0.00%	2.00%	164	3
Hot water pipes insulation (Armaflex 2.5 cm)	0.00%	1.00%	234	2
Other accessories (valves, pressure limiter, etc.)	1.00%	1.50%	6265	157
Condensing gas boiler	1.00%	2.00%	30639	919
Boiler regulation with probe	1.00%	1.50%	7660	191
DHW Cylinder 160L	0.30%	1.00%	2779	36
Steel pipes 1 in	0.00%	0.50%	4323	22
Steel pipes 2 in	0.00%	0.50%	15720	79
Steel pipes 4 in	0.00%	0.50%	5633	28
Steel pipes insulation (Armaflex 2.5 cm)	0.00%	1.00%	1234	12
Steel pipes insulation (Armaflex 3.2 cm)	0.00%	1.00%	12260	123
Steel pipes insulation (Armaflex 4.0 cm)	0.00%	1.00%	10652	107
Regulation pump	0.00%	1.50%	5347	80
Expansion tank 8L	0.50%	2.00%	79	2
Other (header, small pipes, etc.)	0.00%	0.50%	11748	59
Fan coils	0.00%	2.00%	62937	1259
Monobloc chiller	1.00%	2.00%	90744	2722
Plate heat recovery	10.00%	2.00%	15251	1830
Heating coil	1.00%	1.00%	15251	305
Cooling coil	4.00%	2.00%	15251	915
Air transmission: small air ducts	0.50%	0.00%	13553	68
Air transmission: medium air ducts	0.50%	0.00%	2997	15
Air transmission: big air ducts	0.50%	0.00%	323	2
Other (header, small pipes, etc.)	0.00%	0.50%	11748	59
Wire 2.5 mm2 Ho7VU25	1.25%	0.65%	56	1
Wire 6 mm2 Ho7VR6	1.25%	0.65%	990	19

Bare wire 35 mm ²	1.25%	0.65%	140	3
Electrical conduit ICTA 25mm	1.25%	0.65%	832	16
Lighting 2*58W	1.25%	0.65%	34192	650

Moderate climate	Maintenance costs - Equipments			
	Effort on servicing [%]	Effort on repairs [%]	Equipments costs [2012 discounted €]	2012 maintenance costs [2012 discounted €]
PVC DN 50 pipes	0.70%	0.55%	15	0
PVC DN 110 pipes	0.70%	0.55%	193	2
Ceramic toilet bowl (4)	0.70%	0.55%	1366	17
Mixer tap	0.00%	1.00%	50	0
Ceramic washbasins (2)	0.70%	0.55%	611	8
Mixer tap (1 per washbasin)	0.00%	1.00%	153	2
PEHD DN20 pipes	0.00%	2.00%	143	3
Hot water pipes insulation (Armaflex 2.5 cm)	0.00%	1.00%	204	2
Other accessories (valves, pressure limiter, etc.)	1.00%	1.50%	5475	137
Condensing gas boiler	1.00%	2.00%	23282	698
Boiler regulation with probe	1.00%	1.50%	5821	146
DHW Cylinder 160L	0.30%	1.00%	2428	32
Steel pipes 1 in	0.00%	0.50%	3778	19
Steel pipes 2 in	0.00%	0.50%	13738	69
Steel pipes 4 in	0.00%	0.50%	4923	25
Steel pipes insulation (Armaflex 2.5 cm)	0.00%	1.00%	1078	11
Steel pipes insulation (Armaflex 3.2 cm)	0.00%	1.00%	10714	107
Steel pipes insulation (Armaflex 4.0 cm)	0.00%	1.00%	9309	93
Regulation pump	0.00%	1.50%	4673	70
Expansion tank 8L	0.50%	2.00%	69	2
Other (header, small pipes, etc.)	0.00%	0.50%	10266	51
Fan coils	0.00%	2.00%	55000	1100
Monobloc chiller	1.00%	2.00%	97500	2925
Plate heat recovery	10.00%	2.00%	13328	1599
Heating coil	1.00%	1.00%	13328	267
Cooling coil	4.00%	2.00%	13328	800
Air transmission: small air ducts	0.50%	0.00%	11843	59
Air transmission: medium air ducts	0.50%	0.00%	2619	13
Air transmission: big air ducts	0.50%	0.00%	282	1
Other (header, small pipes, etc.)	0.00%	0.50%	10266	51
Wire 2.5 mm ² Ho7VU25	1.25%	0.65%	49	1
Wire 6 mm ² Ho7VR6	1.25%	0.65%	865	16
Bare wire 35 mm ²	1.25%	0.65%	122	2
Electrical conduit ICTA 25mm	1.25%	0.65%	727	14
Lighting 2*58W	1.25%	0.65%	29880	568

Mediterranean climate	Maintenance costs - Equipments			
	Effort on servicing [%]	Effort on repairs [%]	Equipments costs [2012 discounted €]	2012 maintenance costs [2012 discounted €]
PVC DN 50 pipes	0.70%	0.55%	14	0
PVC DN 110 pipes	0.70%	0.55%	174	2
Ceramic toilet bowl (4)	0.70%	0.55%	1234	15
Mixer tap	0.00%	1.00%	45	0
Ceramic washbasins (2)	0.70%	0.55%	552	7
Mixer tap (1 per washbasin)	0.00%	1.00%	138	1
PEHD DN20 pipes	0.00%	2.00%	129	3
Hot water pipes insulation (Armaflex 2.5 cm)	0.00%	1.00%	184	2
Other accessories (valves, pressure limiter, etc.)	1.00%	1.50%	4944	124
Condensing gas boiler	1.00%	2.00%	17869	536
Boiler regulation with probe	1.00%	1.50%	4467	112
DHW Cylinder 160L	0.30%	1.00%	2193	29
Steel pipes 1 in	0.00%	0.50%	3411	17
Steel pipes 2 in	0.00%	0.50%	12404	62
Steel pipes 4 in	0.00%	0.50%	4445	22

Steel pipes insulation (Armaflex 2.5 cm)	0.00%	1.00%	974	10
Steel pipes insulation (Armaflex 3.2 cm)	0.00%	1.00%	9674	97
Steel pipes insulation (Armaflex 4.0 cm)	0.00%	1.00%	8405	84
Regulation pump	0.00%	1.50%	4219	63
Expansion tank 8L	0.50%	2.00%	63	2
Other (header, small pipes, etc.)	0.00%	0.50%	9270	46
Fan coils	0.00%	2.00%	49662	993
Monobloc chiller	1.00%	2.00%	114330	3430
Plate heat recovery	10.00%	2.00%	12034	1444
Heating coil	1.00%	1.00%	12034	241
Cooling coil	4.00%	2.00%	12034	722
Air transmission: small air ducts	0.50%	0.00%	10694	53
Air transmission: medium air ducts	0.50%	0.00%	2365	12
Air transmission: big air ducts	0.50%	0.00%	255	1
Other (header, small pipes, etc.)	0.00%	0.50%	9270	46
Wire 2.5 mm2 Ho7VU25	1.25%	0.65%	44	1
Wire 6 mm2 Ho7VR6	1.25%	0.65%	781	15
Bare wire 35 mm2	1.25%	0.65%	111	2
Electrical conduit ICTA 25mm	1.25%	0.65%	657	12
Lighting 2*58W	1.25%	0.65%	26980	513

Appendix J. - Replacement costs part A

J.1. Shell, core & finishing

			Life span	# of replacements	
Excavation			100	0	
Foundations		Bank - ballast 0/45 mm under floor slab (65 cm)	100	0	
		Concrete foundation	100	0	
		PE film	100	0	
		Geotextile	100	0	
External walls	Loadbearing external walls	Steel structure	50	0	
	External doors and windows	Front band of window with metal frame	40	1	
		Window-door (front entry)	40	1	
		Insulated metal doors (6 doors)	40	1	
		Sectional door	40	1	
	Cladding units	Sandwich panel	50	0	
		Internal concrete blocks (9 cm)	50	0	
		PU insulation (13.5 cm)	50	0	
		External brick (9 cm)	50	0	
		Concrete sill (9*25cm)	50	0	
Internal walls	Loadbearing internal walls	Steel frame	50	0	
		Concrete blocks between metal frame - 20 cm	50	0	
	Non-loadbearing internal walls	Concrete blocks - 14 cm	50	0	
		Internal doors and windows	Internal wood doors (10)	50	0
	Internal linings (of internal walls)	Plaster boards - 15 mm	50	0	
		Stoneware wall tiles (WC)	50	0	
	Floors and ceilings	Floor structures	Reinforced concrete slab ground floor (25 cm)	50	0
			Steel frame	50	0
			2 metal staircases	50	0
			1st floor hollow core slab h=16 cm	50	0
Floorings		Concrete screed 10 cm	50	0	
		PU insulation - 120 mm	50	0	
		Stoneware floor tiles (all surfaces except technical and storage rooms)	50	0	
		Compression slab - 5 cm	50	0	
		Concrete screed - 5 cm	40	1	
Ceiling linings		Ceiling linings	50	0	
		Metal studs for ceiling linings	50	0	
Roofs		Roof structure	Steel frame	50	0
		Roof coverings	Waterproofing membrane (bitumen)	50	0
			Roof insulation	50	0
	Vapour-barrier		50	0	
	Roofing sheet trapezoidal		50	0	
	Roofs, other items	Rainwater gutter	50	0	
		Rainwater pipe (8)	50	0	

		Life span	# of replacements	Construction costs [2012 discounted €]	Year of replacement
External doors and windows		40	1	54974	40
Floorings	Concrete screed - 5 cm	40	1	1032	40
Total replacement costs [2012 discounted €]				25758	

J.2. Equipments

			Life span	# of replacements
Sewerage, water and gas systems	Sewerage systems	PVC DN 50 pipes	50	0
		PVC DN 110 pipes	50	0
	Water supply systems	Ceramic toilet bowl (4)	50	0
		Mixer tap	10	4
		Ceramic washbasins (2)	50	0
		Mixer tap (1 per washbasin)	10	4
		PEHD DN20 pipes	25	1
		Hot water pipes insulation (Armaflex 2.5 cm)	20	2
Heat supply systems	Heat generators	Other accessories (valves, pressure limiter, etc.)	15	3
		Condensing gas boiler	18	2
		Boiler regulation with probe	20	2
	Heat distribution networks	DHW Cylinder 160L	25	1
		Steel pipes 1 in	30	1
		Steel pipes 2 in	30	1
		Steel pipes 4 in	30	1
		Steel pipes insulation (Armaflex 2.5 cm)	20	2
		Steel pipes insulation (Armaflex 3.2 cm)	20	2
		Steel pipes insulation (Armaflex 4.0 cm)	20	2
		Regulation pump	20	2
		Expansion tank 8L	25	1
		Other (header, small pipes, etc.)	15	3
	Space heating	Fan coils	30	1
	Air treatment systems		Monobloc chiller	15
Plate heat recovery			20	2
Heating coil			20	2
Cooling coil			20	2
Air transmission: small air ducts			20	2
Air transmission: medium air ducts			20	2
Air transmission: big air ducts			20	2
Other (header, small pipes, etc.)			30	1
Power installations		Wire 2.5 mm2 Ho7VU25	25	1
		Wire 6 mm2 Ho7VR6	25	1
		Bare wire 35 mm2	25	1
		Electrical conduit ICTA 25mm	25	1
		Lighting 2*58W	25	1

Cold climate	Life span	# of replacements	Construction costs [2012 discounted €]	Years of replacement
Mixer tap	10	4	57	10, 20, 30, 40
Mixer tap (1 per washbasin)	10	4	175	10, 20, 30, 41
PEHD DN20 pipes	25	1	164	25
Hot water pipes insulation (Armaflex 2.5 cm)	20	2	234	20, 40
Other accessories (valves, pressure limiter, etc.)	15	3	6265	15, 30, 45
Condensing gas boiler	18	2	30639	20, 40
Boiler regulation with probe	20	2	7660	20, 40
DHW Cylinder 160L	25	1	2779	25
Steel pipes 1 in	30	1	4323	30
Steel pipes 2 in	30	1	15720	30
Steel pipes 4 in	30	1	5633	30
Steel pipes insulation (Armaflex 2.5 cm)	20	2	1234	20, 40
Steel pipes insulation (Armaflex 3.2 cm)	20	2	12260	20, 40
Steel pipes insulation (Armaflex 4.0 cm)	20	2	10652	20, 40
Regulation pump	20	2	5347	20, 40
Expansion tank 8L	25	1	79	25
Other (header, small pipes, etc.)	15	3	11748	15, 30, 45
Fan coils	30	1	62937	30
Monobloc chiller	15	3	90744	15, 30, 45
Plate heat recovery	20	2	15251	20, 40

Heating coil	20	2	15251	20, 41
Cooling coil	20	2	15251	20, 42
Air transmission: small air ducts	20	2	13553	20, 43
Air transmission: medium air ducts	20	2	2997	20, 44
Air transmission: big air ducts	20	2	323	20, 45
Other (header, small pipes, etc.)	30	1	11748	30
Wire 2.5 mm2 Ho7VU25	25	1	56	25
Wire 6 mm2 Ho7VR6	25	1	990	25
Bare wire 35 mm2	25	1	140	25
Electrical conduit ICTA 25mm	25	1	832	25
Lighting 2*58W	25	1	34192	25
Total replacement costs [2012 discounted €]			418834	

Moderate climate	Life span	# of replacements	Construction costs [2012 discounted €]	Years of replacement
Mixer tap	10	4	50	10, 20, 30, 40
Mixer tap (1 per washbasin)	10	4	153	10, 20, 30, 41
PEHD DN20 pipes	25	1	143	25
Hot water pipes insulation (Armaflex 2.5 cm)	20	2	204	20, 40
Other accessories (valves, pressure limiter, etc.)	15	3	5475	15, 30, 45
Condensing gas boiler	18	2	23282	20, 40
Boiler regulation with probe	20	2	5821	20, 40
DHW Cylinder 160L	25	1	2428	25
Steel pipes 1 in	30	1	3778	30
Steel pipes 2 in	30	1	13738	30
Steel pipes 4 in	30	1	4923	30
Steel pipes insulation (Armaflex 2.5 cm)	20	2	1078	20, 40
Steel pipes insulation (Armaflex 3.2 cm)	20	2	10714	20, 40
Steel pipes insulation (Armaflex 4.0 cm)	20	2	9309	20, 40
Regulation pump	20	2	4673	20, 40
Expansion tank 8L	25	1	69	25
Other (header, small pipes, etc.)	15	3	10266	15, 30, 45
Fan coils	30	1	55000	30
Monobloc chiller	15	3	97500	15, 30, 45
Plate heat recovery	20	2	13328	20, 40
Heating coil	20	2	13328	20, 41
Cooling coil	20	2	13328	20, 42
Air transmission: small air ducts	20	2	11843	20, 43
Air transmission: medium air ducts	20	2	2619	20, 44
Air transmission: big air ducts	20	2	282	20, 45
Other (header, small pipes, etc.)	30	1	10266	30
Wire 2.5 mm2 Ho7VU25	25	1	49	25
Wire 6 mm2 Ho7VR6	25	1	865	25
Bare wire 35 mm2	25	1	122	25
Electrical conduit ICTA 25mm	25	1	727	25
Lighting 2*58W	25	1	29880	25
Total replacement costs [2012 discounted €]			392182	

Mediterranean climate	Life span	# of replacements	Construction costs [2012 discounted €]	Years of replacement
Mixer tap	10	4	45	10, 20, 30, 40
Mixer tap (1 per washbasin)	10	4	138	10, 20, 30, 41
PEHD DN20 pipes	25	1	129	25
Hot water pipes insulation (Armaflex 2.5 cm)	20	2	184	20, 40
Other accessories (valves, pressure limiter, etc.)	15	3	4944	15, 30, 45
Condensing gas boiler	18	2	17869	20, 40
Boiler regulation with probe	20	2	4467	20, 40
DHW Cylinder 160L	25	1	2193	25
Steel pipes 1 in	30	1	3411	30
Steel pipes 2 in	30	1	12404	30
Steel pipes 4 in	30	1	4445	30

Steel pipes insulation (Armaflex 2.5 cm)	20	2	974	20,40
Steel pipes insulation (Armaflex 3.2 cm)	20	2	9674	20,40
Steel pipes insulation (Armaflex 4.0 cm)	20	2	8405	20,40
Regulation pump	20	2	4219	20,40
Expansion tank 8L	25	1	63	25
Other (header, small pipes, etc.)	15	3	9270	15,30,45
Fan coils	30	1	49662	30
Monobloc chiller	15	3	114330	15,30,45
Plate heat recovery	20	2	12034	20,40
Heating coil	20	2	12034	20,41
Cooling coil	20	2	12034	20,42
Air transmission: small air ducts	20	2	10694	20,43
Air transmission: medium air ducts	20	2	2365	20,44
Air transmission: big air ducts	20	2	255	20,45
Other (header, small pipes, etc.)	30	1	9270	30
Wire 2.5 mm2 Ho7VU25	25	1	44	25
Wire 6 mm2 Ho7VR6	25	1	781	25
Bare wire 35 mm2	25	1	111	25
Electrical conduit ICTA 25mm	25	1	657	25
Lighting 2*58W	25	1	26980	25
Total replacement costs [2012 discounted €]				276272

Appendix K. - Construction costs part B

K.1. Initial construction costs (building)

			Construction costs [2012 discounted €]	
Excavation			1135	
Foundations		Bank - ballast 40/60 mm under floor slab	1564	
		Continuous footing	3702	
		PE film	32	
		Geotextile	72	
External walls	Loadbearing external walls	Concrete blocks - 19 cm	9938	
	External doors and windows		6205	
	Cladding units	Earth blocks - 9 cm	20832	
		Stonewool insulation - 10 cm	2930	
	Internal linings (of external walls)	Plaster boards - 15 mm	3694	
Internal walls	Loadbearing internal walls	Concrete blocks - 14 cm	2312	
	Non-loadbearing internal walls	Concrete blocks - 9 cm	2495	
	Internal doors and windows	Internal wood doors	3846	
	Internal linings (of internal walls)	Plaster boards - 15 mm	3182	
Floors and ceilings	Floor structures	Stoneware wall tiles (bathroom and WC)	1197	
		Reinforced concrete slab ground floor (20 cm)	6227	
		Wooden staircase	3326	
		1st floor hollow core slab h=16 cm	4740	
		2nd floor timber beams 75*200 mm	3584	
	Floorings	Concrete screed ground floor 5 cm	964	
		Concrete screed 1st floor 4 cm	964	
		Stoneware floor tiles (bathroom, WC and kitchen)	1693	
		Parquet floor (all other areas)	5281	
	Ceiling linings	Plaster - 15 mm	3593	
	Floors and ceilings, other items	Foldaway stair	88	
	Roofs	Roof structure	Timber frame Purlins (10*15cm or 10*30cm)	1427
			Timber frame Main rafters (10 cm height)	704
Timber frame Rafters for technical space (2.5 cm height)			150	
Roof coverings		Tiles	4796	
		Battens, counter-battens	526	
		Rain-barrier	650	
		Existing external SW insulation 80 mm	1859	
		Vapour-barrier	147	
Roof linings		Plaster boards - 15 mm	2868	
Roofs, other items		Rainwater gutter	191	
		Rainwater pipe	200	
		External walls/Roof junction cladding	432	
		Total		107547

K.2. Initial construction costs (equipments)

			Construction costs [2012 discounted €]
Sewerage, water and gas systems	Sewerage systems	PVC DN 50 pipes	30
		PVC DN 110 pipes	39
	Water supply systems	Ceramic Bathtub	813
		Mixer tap	203
		Ceramic washbasins (2 in bathroom, 1 in WC)	951
		Mixer tap (1 per washbasin)	238
		Ceramic toilet bowl	352
		PEHD DN20 pipes	143
		Hot water pipes insulation (Armaflex 2.5 cm)	245
		Other accessories (valves, pressure limiter, etc.)	323
Heat supply systems	Heat generators	Boiler 25kW Viessmann Vitodens 100W	5060
		Boiler regulation with probe	1265
		DHW Cylinder 160L	2488
	Heat distribution networks	Copper pipes 0.5/0.75 mm (50/50%)	2492
		PEHD distribution pipes DN 20	29
		Regulation pumps Grundfos Alpha 2 XX-40	684
		Expansion tank 8L	69
	Space heating	1 steel radiator by room (8 rooms +/- 3 kW)	2310
		Radson PARADA type 33 1200*600mm	
Power installations		Wire 2.5 mm ² Ho7VU25	162
		Wire 6 mm ² Ho7VR6	14
		Bare wire 35 mm ²	119
		Electrical conduit ICTA 25mm	112
		Total	18143

K.3. PU renovation costs

			Construction costs [2012 discounted €]
Roof coverings	Tiles		4796
	Battens, counter-battens		529
	Rain-barrier		650
	New PU insulation 100 mm		3772
	Vapour-barrier		466
	Existing roof removal		1174
Roofs, other items	Rainwater gutter		191
	Rainwater pipe		200
	External walls/Roof junction cladding		430
	Total		12206

K.4. SW renovation costs

			Construction costs [2012 discounted €]
Roof structure	Timber frame Rafters for technical space (2.5 cm height)		151
Roof coverings	Tiles		4796
	Battens, counter-battens		529
	Rain-barrier		650
	New SW insulation 100 mm		1824
	New SW insulation 135 mm		3988
	Vapour-barrier		466
	Existing roof removal		1174
Roof linings	Plaster boards - 15 mm		2868

Roofs, other items	Rainwater gutter	191
	Rainwater pipe	200
	External walls/Roof junction cladding	430
	Total	17266

K.5. GW renovation costs

		Construction costs [2012 discounted €]
Roof coverings	Tiles	4796
	Battens, counter-battens	529
	Rain-barrier	650
	New GW insulation 100 mm between rafters	1753
	New SW insulation 100 mm under rafters	1912
	Metal studs for GW insulation	160
	Support pillar for GW insulation	491
	Vapour-barrier	466
	Existing roof removal	1174
Roof linings	Plaster boards - 15 mm	2868
Roofs, other items	Rainwater gutter	191
	Rainwater pipe	200
	External walls/Roof junction cladding	430
	Total	15619

K.6. WF renovation costs

		Construction costs [2012 discounted €]
Roof structure	Timber frame Rafters for technical space (2.5 cm height)	151
Roof coverings	Tiles	4796
	Battens, counter-battens	529
	Rain barrier	1354
	New WF insulation 100 mm between rafters	2902
	New WF insulation 125 mm above rafters	3759
	Vapour-barrier	466
	Existing roof removal	1174
	Roof linings	Plaster boards - 15 mm
Roofs, other items	Rainwater gutter	191
	Rainwater pipe	200
	External walls/Roof junction cladding	430
	Total	18818

K.7. Costs of insulation materials, example of PU

Insulation prices come from custom prices (detailed data). Prices are calculated using a linear regression on averaged data from various brands.

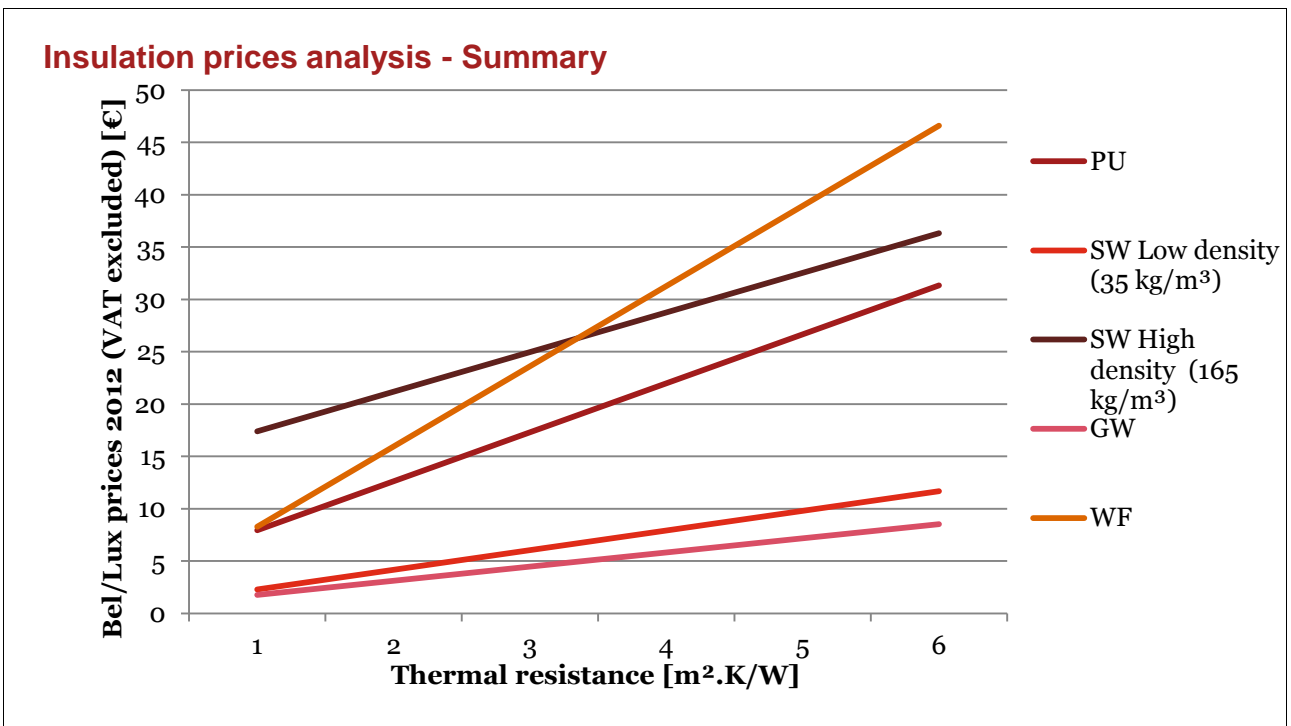
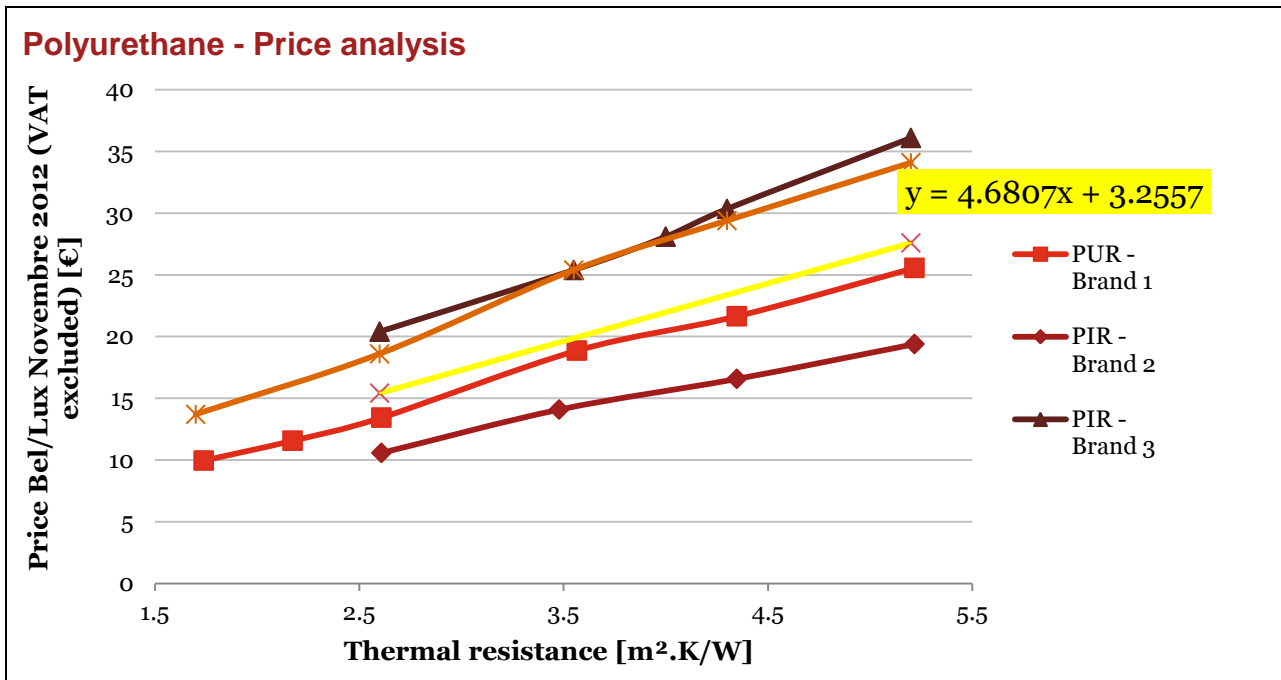

Insulation	Linear regression	R [m².K/W]	Price [€/m² VAT excluded]
PU	$y = 4.6807x + 3.2557$	4.35	23.6
SW LD	$y = 1.8777x + 0.4263$	2.78	5.64
SW HD	$y = 3.7867x + 13.61$	3.375	26.39
GW	$y = 1.3541x + 0.4084$	3.125	4.64
WF	$y = 7.6585x + 0.6368$	2.632	20.79
WF		2.976	23.43

The above prices include only materials. Additional costs for labor are assumed to be:

- 25 €/m² for insulation above rafters;
- 20 €/m² for insulation between rafters.

Appendix L. - Maintenance costs part B

L.1. Shell, core & finishing

	Maintenance costs - Shell core & finishing					
	Effort on servicing [%]	Effort on repairs [%]	Base costs before renovation [2012 discounted €]	Base costs after renovation [2012 discounted €]	2012 maintenance costs [2012 discounted €]	Life cycle cost [2012 discounted €]
PU renovation	0.1%	1.0%	107547	112810	1183	59718
SW renovation	0.1%	1.0%	107547	112992	1183	59781
GW renovation	0.1%	1.0%	107547	111346	1183	59207
WF renovation	0.1%	1.0%	107547	114544	1183	60322

L.2. Equipments

	Maintenance costs - Equipments				
	Effort on servicing [%]	Effort on repairs [%]	Base costs before renovation [2012 discounted €]	Base costs after renovation [2012 discounted €]	2012 maintenance costs [2012 discounted €]
PVC DN 50 pipes	0.70%	0.55%	30	30	0.4
PVC DN 110 pipes	0.70%	0.55%	39	39	0.5
Ceramic Bathtub	0.70%	0.55%	813	813	10.2
Mixer tap	0.00%	1.00%	203	203	2.0
Ceramic washbasins (2 in bathroom, 1 in WC)	0.70%	0.55%	951	951	11.9
Mixer tap (1 per washbasin)	0.00%	1.00%	238	238	2.4
Ceramic toilet bowl	0.70%	0.55%	352	352	4.4
PEHD DN20 pipes	0.00%	2.00%	143	143	2.9
Hot water pipes insulation (Armaflex 2.5 cm)	0.00%	1.00%	245	245	2.5
Other accessories (valves, pressure limiter, etc.)	0.10%	1.50%	323	323	5.2
Boiler 25kW Viessmann Vitodens 100W	1.00%	2.00%	5060	5060	151.8
Boiler regulation with probe	1.00%	1.50%	1265	1265	31.6
DHW Cylinder 160L	0.30%	1.00%	2488	2488	32.3
Copper pipes 0.5/0.75 mm (50/50%)	0.00%	0.50%	2492	2492	12.5
PEHD distribution pipes DN 20	0.00%	0.50%	29	29	0.1
Regulation pumps Grundfos Alpha 2 XX-40	0.00%	1.50%	684	684	10.3
Expansion tank 8L	0.50%	2.00%	69	69	1.7
1 steel radiator by room (8 rooms +/- 3 kW) Radson PARADA type 33 1200*600mm	0.00%	1.00%	2310	2310	23.1
Wire 2.5 mm ² H07VU25	1.25%	0.65%	162	162	3.1
Wire 6 mm ² H07VR6	1.25%	0.65%	14	14	0.3
Bare wire 35 mm ²	1.25%	0.65%	119	119	2.3
Electrical conduit ICTA 25mm	1.25%	0.65%	112	112	2.1

Appendix M. - Replacement costs part B

M.1. Shell, core & finishing (existing)

			Life span	# of replacements	Construction costs [2012 discounted €]	
Excavation			100	0	1135	
Foundations		Bank - ballast 40/60 mm under floor slab	100	0	1564	
		Continuous footing	100	0	3702	
		PE film	100	0	32	
		Geotextile	100	0	72	
External walls	Loadbearing external walls	Concrete blocks - 19 cm	100	0	9938	
	External doors and windows		40	1	6205	
	Cladding units	Earth blocks - 9 cm	100	0	20832	
		Stonewool insulation - 10 cm	100	0	2930	
	Internal linings (of external walls)	Plaster boards - 15 mm	100	0	3694	
Internal walls	Loadbearing internal walls	Concrete blocks - 14 cm	100	0	2312	
	Non-loadbearing internal walls	Concrete blocks - 9 cm	100	0	2495	
	Internal doors and windows	Internal wood doors	50	1	3846	
	Internal linings (of internal walls)	Plaster boards - 15 mm	50	1	3182	
		Stoneware wall tiles (bathroom and WC)	50	1	1197	
Floors and ceilings	Floor structures	Reinforced concrete slab ground floor (20 cm)	100	0	6227	
		Wooden staircase	100	0	3326	
		1st floor hollow core slab h=16 cm	100	0	4740	
		2nd floor timber beams 75*200 mm	100	0	3584	
	Floorings	Concrete screed ground floor 5 cm	100	0	964	
		Concrete screed 1st floor 4 cm	100	0	964	
		Stoneware floor tiles (bathroom, WC and kitchen)	50	1	1693	
		Parquet floor (all other areas)	40	1	5281	
	Ceiling linings	Plaster - 15 mm	50	1	3593	
	Floors and ceilings, other items	Foldaway stair	50	1	88	
	Roofs	Roof structure	Timber frame Purlins (10*15cm or 10*30cm)	100	0	1424
			Timber frame Main rafters (10 cm height)	100	0	705
Timber frame Rafters for technical space (2.5 cm height)			100	0	151	
Existing external SW insulation 80 mm			100	0	1859	

		Life span	# of replacements	Construction costs [2012 discounted €]	Year of replacement
External doors and windows		40	1	6205	40
Internal doors and windows	Internal wood doors	50	1	3846	50
Internal linings (of internal walls)	Plaster boards - 15 mm	50	1	3182	50
	Stoneware wall tiles (bathroom and WC)	50	1	1197	50
	Stoneware floor tiles (bathroom, WC and kitchen)	50	1	1693	50
	Parquet floor (all other areas)	40	1	5281	40
Ceiling linings	Plaster - 15 mm	50	1	3593	50
Floors and ceilings, other items	Foldaway stair	50	1	88	50
				Total replacement costs [2012 discounted €]	13961

M.2. Equipments

			Life span	# of replacements	Construction costs [2012 discounted €]	
Sewerage, water and gas systems	Sewerage systems	PVC DN 50 pipes	50	1	30	
		PVC DN 110 pipes	50	1	39	
	Water supply systems	Ceramic Bathtub	50	1	813	
		Mixer tap	10	6	203	
		Ceramic washbasins (2 in bathroom, 1 in WC)	50	1	951	
		Mixer tap (1 per washbasin)	10	6	238	
		Ceramic toilet bowl	50	1	352	
		PEHD DN20 pipes	25	2	143	
		Hot water pipes insulation (Armaflex 2.5 cm)	20	3	245	
		Other accessories (valves, pressure limiter, etc.)	15	4	323	
Heat supply systems	Heat generators	Boiler 25kW Viessmann Vitodens 100W	18	3	5060	
		Boiler regulation with probe	20	3	1265	
		DHW Cylinder 160L	25	2	2488	
	Heat distribution networks	Copper pipes 0.5/0.75 mm (50/50%)	30	2	2492	
		PEHD distribution pipes DN 20	30	2	29	
		Regulation pumps Grundfos Alpha 2 XX-40	20	3	684	
		Expansion tank 8L	25	2	69	
	Space heating	1 steel radiator by room (8 rooms +/- 3 kW) Radson PARADA type 33 1200*600mm	35	1	2310	
	Power installations		Wire 2.5 mm2 Ho7VU25	25	2	162
			Wire 6 mm2 Ho7VR6	25	2	14
		Bare wire 35 mm2	25	2	119	
		Electrical conduit ICTA 25mm	25	2	112	

	Life span	# of replacements	Construction costs [2012 discounted €]	Years of replacement
PVC DN 50 pipes	50	1	30	50
PVC DN 110 pipes	50	1	39	50
Ceramic Bathtub	50	1	813	50
Mixer tap	10	6	203	10-20-30-40-50-60
Ceramic washbasins (2 in bathroom, 1 in WC)	50	1	951	50
Mixer tap (1 per washbasin)	10	6	238	10-20-30-40-50-60
Ceramic toilet bowl	50	1	352	50
PEHD DN20 pipes	25	2	143	25-50
Hot water pipes insulation (Armaflex 2.5 cm)	20	3	245	20-40-60
Other accessories (valves, pressure limiter, etc.)	15	4	323	15-30-45-60
Boiler 25kW Viessmann Vitodens 100W	18	3	5060	18-36-54
Boiler regulation with probe	20	3	1265	20-40-60
DHW Cylinder 160L	25	2	2488	25-50
Copper pipes 0.5/0.75 mm (50/50%)	30	2	2492	30-60
PEHD distribution pipes DN 20	30	2	29	30-60
Regulation pumps Grundfos Alpha 2 XX-40	20	3	684	20-40-60
Expansion tank 8L	25	2	69	25-50
1 steel radiator by room (8 rooms +/- 3 kW) Radson PARADA type 33 1200*600mm	35	1	2310	35
Wire 2.5 mm ² Ho7VU25	25	2	162	25-50
Wire 6 mm ² Ho7VR6	25	2	14	25-50
Bare wire 35 mm ²	25	2	119	25-50
Electrical conduit ICTA 25mm	25	2	112	25-50
			Total replacement costs [2012 discounted €]	27288

All renovation components have an assumed life span of more than 50 years. Thus, no cost is due to replacement of renovation components.

Appendix N. - Energy prices

Bibliography

N.1. DGNB Steckbrief 16

Neubau Büro- und Verwaltungsgebäude		Planung und Errichtung	Version 2009	
Steckbrief-Nr.:	⁰¹ NBV09-16	Stand:	⁰² v 2.0	Seite 22 / 22
Bezeichnung	⁰³ Gebäudebezogene Kosten im Lebenszyklus			23.07.2010

ANLAGE STB16_05:

PREISSTEIGERUNG	
Für die Berechnung der Lebenszykluskosten werden folgende Zinssätze vorgegeben:	
Preissteigerung:	Mittelwert 2%
Kapitalzins:	Mittelwert 5,5%
Abweichend von der allgemeinen mittleren Preissteigerung gilt für Heiz- und Elektroenergie:	
Preissteigerung Heiz- und Elektroenergie	Mittelwert 4%

Figure 120 – DGNB assumptions for energy price evolution

DGNB Steckbrief 16 assumes a 4% increase rate both for gas and electricity prices.

N.2. VDI 2067



Bild 4. Entwicklung des Energie-, Investitions- und Lohnindexes

Fig. 4. Index trends for power, investments and wages

Figure 4 represents the index trend for wages, investments and power according to the figures published by the Federal Statistical Office since 1968:

for power	3.0 %/year,
for investment goods	2.7 %/year,
for wages	3.3 %/year.

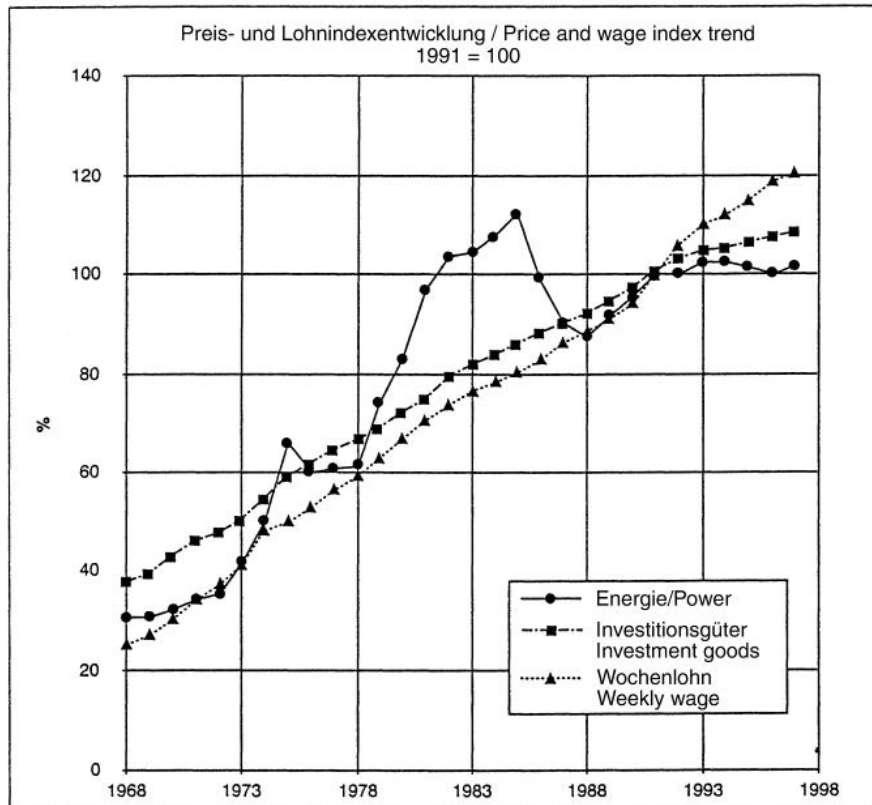
Figure 121 – VDI 2067 assumptions for energy price evolution

VDI 2067 shows a strong link between energy prices, investment goods and wages prices. Between 1968 and 1998, the mean increase rate for energy prices is 3% per year.

Appendix O. - *LCC definitions*

Definitions

Some important terms in the frame of LCC are listed below (ISO 15686-5):

Life cycle cost: the cost of an asset, or its parts throughout its life cycle, while fulfilling the performance requirements.

Maintenance costs: total of necessarily incurred labor, material and other related costs incurred to retain a building or its parts in a state in which it can perform its required functions.

Operation costs: costs incurred in running and managing the facility or built environment, including administration support services.

Discounted cost: resulting cost when the real cost is discounted by the real discount rate or when the nominal cost is discounted by the nominal discount rate.

Nominal cost: expected price that will be paid when a cost is due to be paid, including changes in price due to, for example, forecast changes in efficiency, inflation or deflation and technology.

Real cost: cost expressed as value as at the base date, including estimated changes in price due to forecast changes in efficiency and technology, but excluding general price inflation or deflation.

Net present value: sum of the discounted future cash flows.

Discount rate: factor or rate reflecting the time value of money that is issued to convert cash flows occurring at different times to a common time.

Nominal discount rate: factor or rate used to relate present and future money values in comparable terms taking into account the general inflation/deflation rate.

Real discount rate: factor or rate used to relate present and future money values in comparable terms not taking into account the general or specific inflation in the cost of a particular asset under consideration.

Inflation/deflation rate: sustained increase/decrease in the general price level.

Appendix P. - *Specific methodology to determine representative EPDs for glass wool and stone wool*

European average EPDs for glass wool and stone wool insulation products are not available. This is why a specific methodology has been used to select representative EPDs among data published by European manufacturers.

1. Creating a dataset from various products and different databases
2. Normalizing a selection of indicators (total primary energy consumption, climate change, resource depletion) on thermal resistance and on density
3. Excluding extreme values from each series of EPDs
4. Determining median, minimum and maximum data sources after analyzing the dispersion of the different impacts.
5. Impacts are extrapolated according to U-values expected for the present study

The “median” EPDs have been selected as reference sources in the study. Sensitivity analysis have been based on “minimum” and “maximum” EPDs to compare overall results calculated from the different data and validate the representativity of the chosen EPDs.

In the following sections explanations are provided on the method applied to select environmental data for insulating materials that justifies the choice of EPDs for these products.

Stone wool

EPDs from INIES (French database) and IBU (German database) have been considered. These EPDs have been realized by 3 different manufacturers: Isover, Rockwool and Knauf. The most representative EPDs for the studied product are those related to high density products (ie. between 90 to 140 kg/m³).

To select the appropriate EPD we did a comparative analysis on the indicators “Climate change”, and “Total primary energy”, the most common indicators in Life Cycle Analyses. The results are as follows.

In every graph, the green circle indicates the data from French EPDs. The other EPDs are from the IBU database.

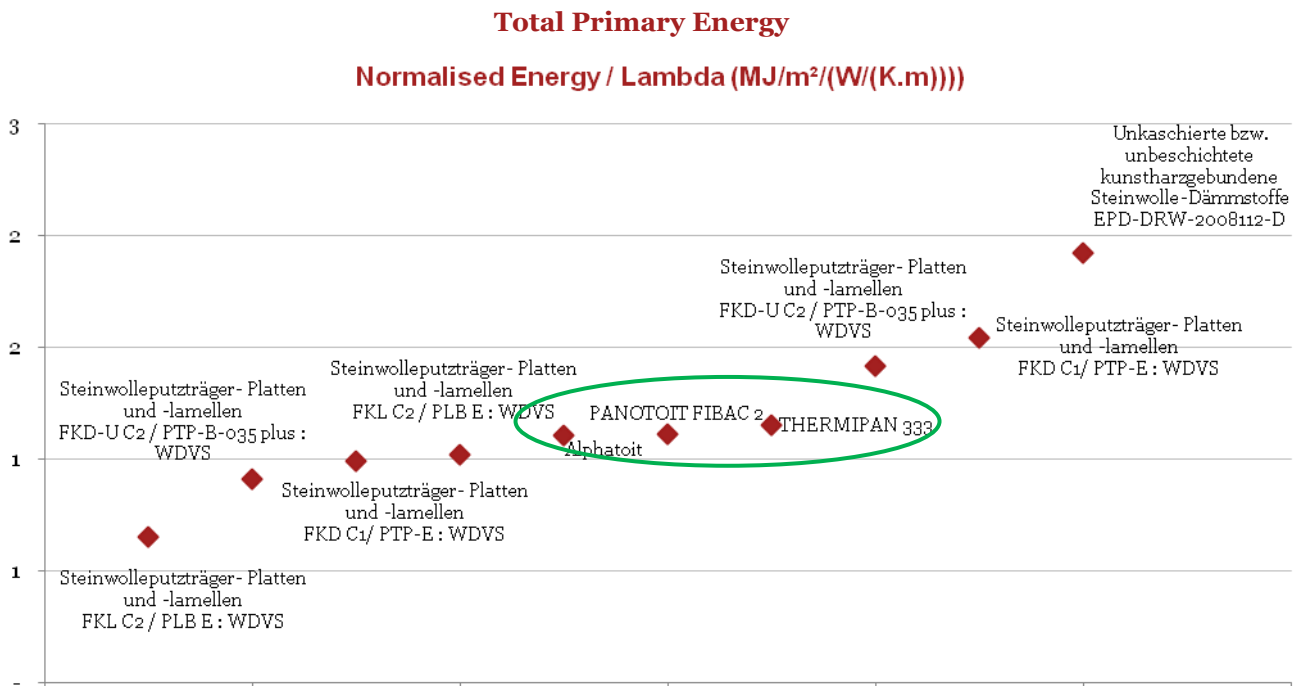

Figure 122 – stone wool environmental data, total primary energy

Climate Change

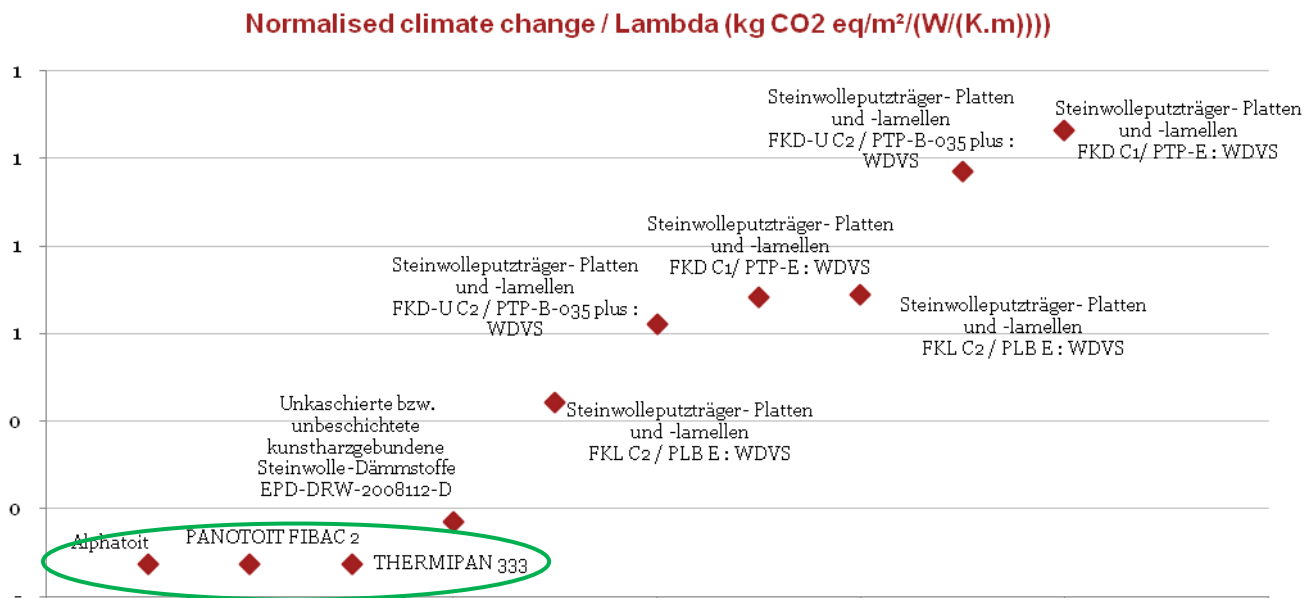

Figure 123 – stone wool environmental data, climate change

Observations

- The total primary energy consumptions calculated in the French EPDs are in the average of the sample.

- Climate Change impacts calculated in the French EPDs are lower than in the other EPDs from the IBU database.
- French EPDs present a comprehensive set of indicators whereas it is not the case for the EPDs from the IBU database which present 6 to 7 indicators versus 8 for the French EPDs

Conclusion

For these reasons we decided to choose an EPD among the French ones, considering they present roughly the same impact values for the 2 indicators analyzed. We chose the EPD whose modeling corresponds best to the product considered: Thermipan 333 (Isover). The impact values for Climate Change of this EPD are rather low. In these conditions, the choice of the EPD representing stonewool insulation does not favor PU as its impact values are equal to or below the average of the sample for the indicators considered.

Glass wool

EPDs available from INIES (French database) and IBU (German database) have been considered.

To select the appropriate EPD we did a comparative analysis on the indicators “Climate change” and “Total primary energy” for those EPDs. The results are as follows.

- The red circles show the EPDs that have been dismissed as their results are too far from the other EPDs.
- The brown rectangles indicate the EPDs chosen as maximal and minimal values which will be used in the sensitivity analysis. These EPDs present the maximal and minimal impacts for the Climate Change and Total primary energy consumption indicators apart from the EPDs previously dismissed.
- The green rectangle represents the EPD with the median impact values for the Climate Change and Total primary energy consumption indicators. It has been chosen as the reference EPD in the study.

Total Primary Energy

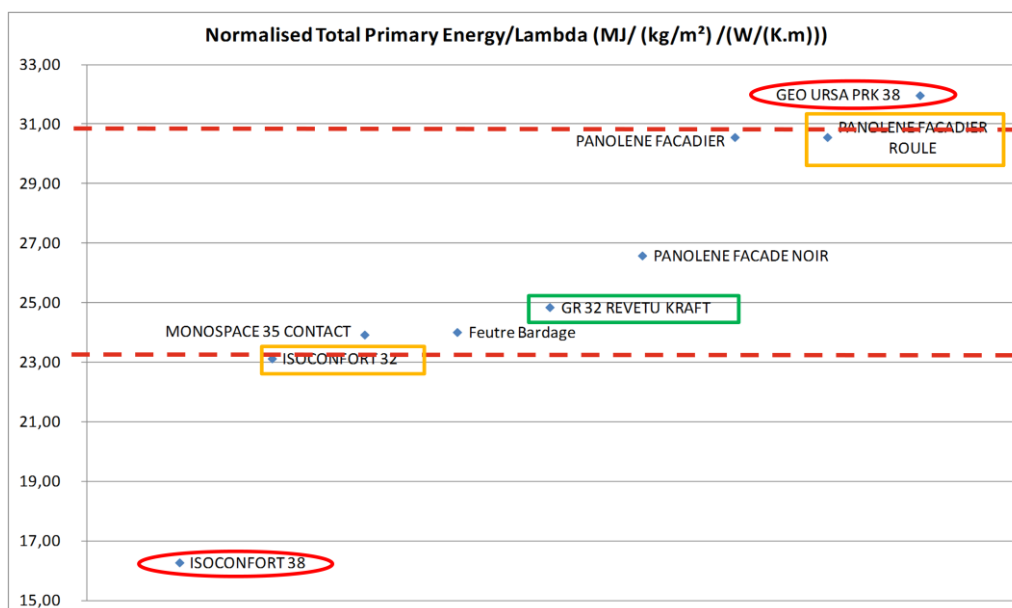

Figure 124 – glass wool environmental data, total primary energy

Climate Change

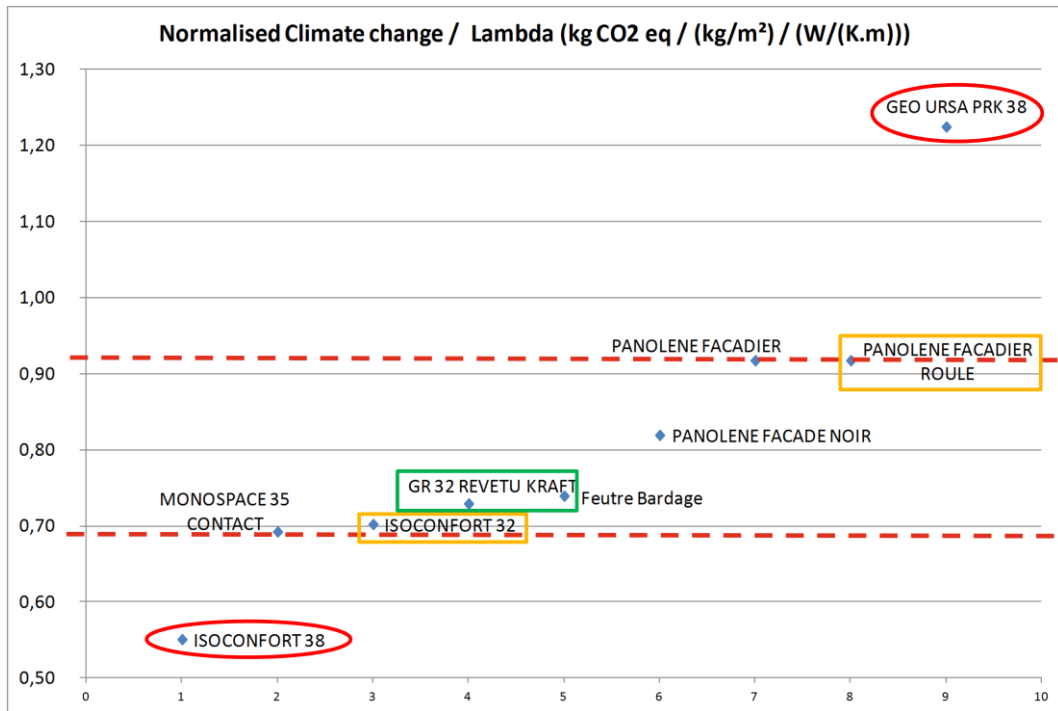

Figure 125 – glass wool environmental data, climate change

A sensitivity analysis on the results for the residential house has been performed and a conclusion provided in section 8.